

WIGGENS

THE MAGIC MOTION

EN



Version-2022-2

About WIGGENS

What Does Wiggins Stand for?

Wide Product Range
International Orientation
Great Quality
Great Service
Energetic Team
New Technology
Solutions

WIGGENS
THE MAGIC MOTION

Wiggins was established in 2005 with the goal of delivering the best laboratory equipment and service for reliable results. Since then Wiggins has been producing top-quality general laboratory equipment, analysis apparatus and chemical reaction solutions. Our brand Wiggins stands for high quality, durability and remarkable performance.

Wiggins is your reliable laboratory companion and provides products that can be used in different kinds of laboratory environments. The Wiggins product range includes:

- * Rotary Evaporator
- * Pump
- * Vacuum Filtration Apparatus
- * Heating & Mixing unit
- * Incubator & Oven
- * Analysis Apparatus
- * Gas Generator
- * Chemical Reactor

ChemVak, the product brand of Wiggins, is specialized in vacuum technology offering an extensive range of vacuum pumps for all applications, including chemical-resistant diaphragm pumps, oil-free pumps and rotary vane vacuum pumps, complemented by vacuum filtration equipment for a wide range of different applications. In addition, solvent recovery systems and bio-suction systems are part of the product range.

ChemTron is our product brand focusing on analysis apparatus, gas generators and chemical reaction solutions, as well as efficient chemical separation tools-rotary evaporator.



Innovation

New concepts and solutions
Customers as generator of ideas
Friendly and modern working atmosphere

Thinking the unusual is usual for us.

Competence

Specialists in all teams
Expert knowledge and experience

Quality

Reliability
ISO 9001
Strong After Sales Service
Made in Germany, China, Switzerland & USA

Flexibility

Special Design, customized products
Constant feedback from subsidiaries and customers

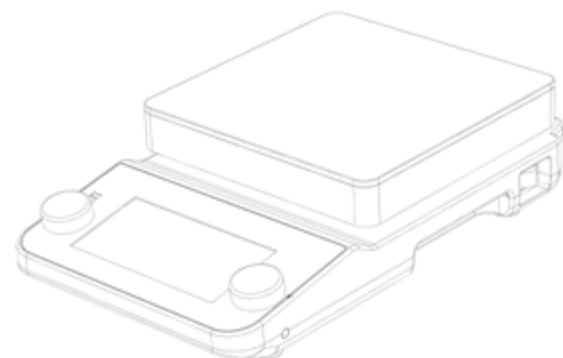

Contents

Rotary evaporator	05	Shaker	134
Vacuum Pump	27	> Orbital Shaker.....	135
> Application Guide.....	31	> Shaker for CO ₂ Incubator.....	138
> Chemical Resistant Diaphragm Pump.....	33	> Rocking Shaker.....	139
> Vacuum Solvent Recovery System.....	42	> Waving Shaker.....	140
> Oil-Free Piston Vacuum Pump.....	47	> Microplate Shaker.....	141
> Rotary Vane Vacuum Pump.....	49	> Heating Shaker.....	142
> Electrical Aspirator Pump.....	52	> Vortex Shaker.....	143
Vacuum Filtration	53	> Digital Pulse Mixer.....	147
> Portable vacuum filtration system.....	55	> Cell Culture Roller Rack.....	148
> Bench-top vacuum filtration system.....	56	> Roller Apparatus.....	149
> Filtration Set.....	57	> Roller Apparatus.....	149
> Multi-Position Filtration System.....	62	> Separatory Funnel Shaker.....	150
> Accessories For Filtration System.....	66	Incubator / Oven	152
Liquid Handling Equipment	69	> CO ₂ Incubator.....	153
> Peristaltic Pump.....	70	> Peltier-cooled CO ₂ Incubator.....	155
> Portable Suction Unit (Aspirator).....	72	> Portable Mini CO ₂ Incubator.....	157
> Vdose Syringe Pump.....	74	> Tri-Gas Incubator.....	158
Hot Plate / Stirrer	75	> Constant Temperature Incubator.....	160
> Digital Hot Plate / Stirrer.....	78	> Low Temperature Incubator.....	162
> Soft Dry Bath.....	84	> Peltier-cooled Incubator.....	163
> Magnetic Stirrer.....	87	> Forced Convection Oven.....	164
> Submersible Magnetic Stirrer.....	88	Shaking Incubator / CO₂ Shaking Incubator ..	165
> Infrared Hot Plate.....	90	> Shaking Incubator.....	166
> Digital Hot Plate.....	91	> Accessories for Shaker Incubator.....	167
> Multi-Purpose Heater / Dry Bath.....	92	> CO ₂ Incubator with Roller installed inside.....	169
> COD Reactor.....	93	> CO ₂ Incubator with Shaker installed inside.....	169
> Heating & Cooling Block.....	94	> CO ₂ Shaking Incubator.....	170
> Multi-Purpose Heater / Dry Bath.....	95	Ultrasonic Cleaner	172
> Soxhlet Extraction System (SES).....	97	> Ultrasonic Cleaner.....	173
> Multi-Position Heating Mantle.....	98	> Ultrasonic Shaking Water Bath.....	174
> Soxhlet Extraction 6-position Heating Plate.....	99	Wiggins Analytics	175
> Temperature and stirring controller.....	101	> Auto Titrator.....	176
Overhead Stirrer	103	> Portable pH Meter.....	182
> Overhead Stirrer.....	105	> Portable Dissolved Oxygen Meter.....	182
> High Torque / High Speed Overhead Stirrer.....	107	> Portable Conductivity Meter.....	183
> Remotely Controllable High Torque / High Speed Stirrer.....	109	> Digital LUX Meter.....	183
> Accessories for Overhead Stirrer.....	111	> Benchtop pH Meter.....	184
Homogenizer	120	> Benchtop Conductivity Meter.....	184
> Handheld Homogenizer.....	121	> Refractometer.....	186
> High Speed Homogenizer.....	122	Gas Generator	188
> Flapping Homogenizer (Stomacher).....	130		
> Lab Burner.....	132		
> Colony Counter.....	132		
> Sensor-controlled turntable for Petri dishes.....	133		

Rotary evaporator

Laboratory Rotary Evaporator
Up to 2L



STRIKE 285
Rotary Evaporator



STRIKE 385
Rotary Evaporator

Large Rotary Evaporator
6L, 10L, 20L



STR



Continuous Distillation Rotary Evaporator ST20 CRE
Reliable PLC controlling system



Explosion-Proof Type - ST20 ATEX



ROTARY EVAPORATOR STRIKE A GENERATION AHEAD



Rotary Evaporator

Strike 285

The rotary evaporator Strike 285 combines excellent operating characteristics and high performance levels, all in an ergonomic design, offering excellent separation, concentration and purification solutions. All Functions can be viewed and monitored on the large and clear Touch Screen display, the parameters can be set by touch screen, the turning knob or using both the same time for fast adjustment, the user can reduce the process time by using the programs for automatic distillation with the integrated temperature controller, vacuum controller, timer and other special features.

The evaporation flask is connected to vapor tube via coupling ring for easy fixing and removal of the flask, and the flask ejector design allows you to remove the sticking flasks from vapor tube in easy way by just turning the ejector

Features



● Sealing system

- > The unique sealing system allows a perfect vacuum-tight and anti-corrosion
- > With chemically resistant gasket, suitable for various samples
- > This sealing system is a standard feature in all strike models and can be used with all types of glassware sets



● Mechanical structure

- > With electric lifting device, adjustable stroke, and it can also stop at any position
- > With powerful rotation motor, the speed up to 280 rpm
- > Adjustable angle of the evaporating flask can be individually set according to your needs



● Glassware set

- > All glassware sets are also available with transparent plastic coating for added safety
- > Four types of condensers
- > Different volumes of evaporating and receiving flasks
- > Standard package includes one 1,000ml evaporating flask and one 1,000ml receiving flask
- > Other accessories are optional, such as adapters, anti-sprinkling bubbles, vapor tubes...



● Vapor tube

- > Evaporating flasks and vapor tubes come with a standard NS 29/32 joint
- > PTFE sleeves ensure tight sealing while preventing the glass from sticking together
- > Easy to disassemble, clean and replace the parts



● Thread locking design

- > With screw thread locking function, screw cap is fixed by clip spring to prevent loss
- > The screw cap can be removed for installing other evaporating flasks with different connectors
- > Made of corrosion-resistant material



● Display and operation

- > Touch screen with multi-language user interface
- > Easy to operate using the turn & push knob
- > Multifunction display, for bath temperature, rotation speed, vacuum, vapor and condenser cooling water temperature



● Function

- > Custom method, one-click start, after booting to save the last settings
- > Up to 9 steps programmable distillation conditions
- > Timing function distillation: The distillation program will be closed automatically when the setting time is reached



● Safety

- > A safety heating bath with overheating and dry running protection
- > In case of a power outage, electric lifting device remove the flask from the heating bath to prevent the safety issues and potential thermal damage to your sample
- > The shield is standard for all models. It can be removed by the operator and fitted beside the instrument

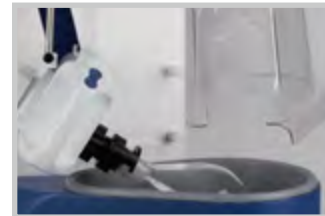

● Heating bath

- > With the same thermostat bath, you can choose the water or oil bath fluid in the MENU
- > Two bath fluid modes: up to 85°C with water, up to 185°C with oil
- > High strength stamped inner bath and anti-corrosion PTFE coating
- > With high quality protective shell, prevent scald
- > The position of the bath can be easily adjusted to fix the evaporation position for different volume evaporating flasks



● Optional accessories and peripheral modules

- > Vacuum controller: the vacuum can be set and displayed directly on the touch screen
- > Vapor temperature sensor with glass sleeve
- > Vacuum pumps, vacuum solvent recovery system, chillers, adapters and tubes



Display and operation

① Main interface

Click the touch screen, select the setting icon, set the parameters through the knob, press the knob to save the value

- > Rotation switch and speed knob
- > Bath temperature switch and settings
- > Vacuum switch and settings
- > Vapor temperature display, when connected to a vapor temperature sensor
- > Cooling temperature display, when connected to a cooling temperature sensor

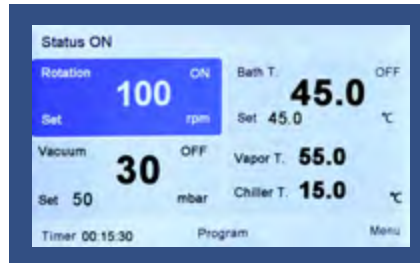

①

During the experiment, all information can be displayed on the same screen

② Menu

- > Safety temperature settings for the bath
- > Temperature unit
- > Vacuum unit
- > Delta of vacuum
- > Language
- > Timer

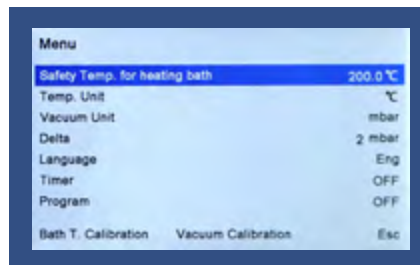

②

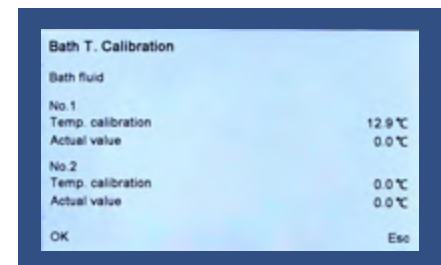

④

③ Program

All the parameters:

Up to 9 steps programmable distillation conditions including the bath temperature, rotation speed, vacuum, vacuum delta and can be set separately in each step

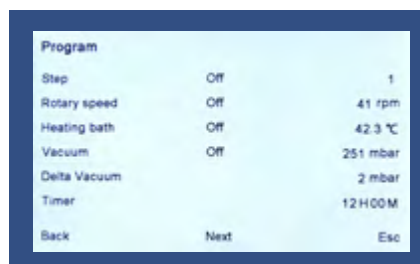

③

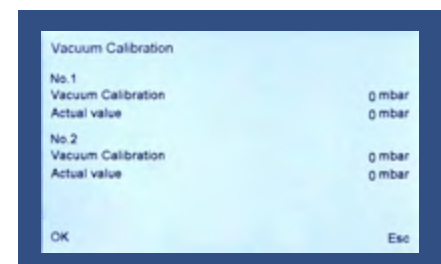

⑤

④ Bath temperature calibration (two points)

⑤ Vacuum calibration (two points)



Specifications

Technical data	STRIKE 285
Models	Slanting glassware, Vertical glassware (Vapor sinking), Vertical glassware (Vapor rising), Dry ice condensation type
Glassware	Standard or plastic-coated glassware
Rotation speed	20 to 300 rpm (DC motor)
Screen	4.3" monochromatic LCD touch screen
Sealing	PTFE and carbon graphite seals
Connection	Coupling ring and ejector of evaporation flask
Bath temperature	180°C (combination with water or oil)
Bath heater	1400W
Bath capacity	5 liters
Temperature stability	±2°C
Bath material	PTFE coated molded aluminum tank
Left and right moving distance	90mm
Draining	Removable bath for emptying
Stroke displacement	13cm, adjustable, and can be stopped at any position
Head angle adjustable	0~15°
Cooling surface	1500cm ²
Evaporating flasks	1000ml (optional 50 to 2000ml)
Collecting flasks	1000ml (optional 250 to 2000ml)
Weight	26,5 Kg (vertical version), 26 Kg (slanting version)
Overall dimensions	690x700x430mm (vertical version,HxDxL) 690x790x430mm (slanting version,HxDxL)
Voltage	230 V AC, 50Hz
Options	Vapor temperature probe, condenser cooling water temperature probe, vacuum pump and controller, chiller...
Protective shield	Glassware lifting up possible with or without the protective shield
Other features	Powered glassware lifting up device with safety release (in case of power failure) Quick start/stop control and parameter selector

Models of STRIKE 285



STRIKE 285 M1 / M4
Slanting glassware



STRIKE 285 M2 / M5
Vertical glassware (Vapor sinking)



STRIKE 285 M3 / M6
Vertical glassware (Vapor rising)



STRIKE 285 M7
Dry ice condensation type

Configurations in standard glassware

Order Number	Model	Type	Voltage	Version
SQED158113	STRIKE 285 M1	Slanting glassware	220V	O
SQED158112	STRIKE 285 M2	Vertical glassware (Vapor sinking)	220V	V
SQED158111	STRIKE 285 M3	Vertical glassware (Vapor rising)	220V	U

Configurations in plastic coated safety glassware

Order Number	Model	Type	Voltage	Version
SQED158419	STRIKE 285 M4	Slanting glassware	220V	O/P
SQED158418	STRIKE 285 M5	Vertical glassware (Vapor sinking)	220V	V/P
SQED158417	STRIKE 285 M6	Vertical glassware(Vapor rising)	220V	U/P
SQED158420	STRIKE 285 M7	Dry ice condensation type	220V	C

NOTE: Other glassware versions are available upon specific request

Rotary Evaporator

Strike 385

STRIKE 385



Features

Strike 385 almost has all of the features and functions as Strike 285, but also with the following characteristics, which is ideal for more complex distillation and experimental needs.



● Display

- > Touch screen with multi-language user interface, and it can be locked
- > Easy to operate only using the turn & push knob
- > Multifunction display, for bath temperature, rotation speed, vacuum, vapor and condenser cooling water temperature



● Features

- > Custom method, one-click start, after booting to save the last settings
- > Standard method: customers can save the current settings as a standard method, easy to quickly call in the future; Up to 21 methods can be stored
- > Manual multistage distillation. At the end of each step, it needs to be confirmed by the operator, and then move on to the next step. Up to 21 methods can be stored, and 5 steps can be set for each of them.
- > Automatic multistage distillation. At the end of each step, it automatically moves to the next step (application examples: concentration). Up to 21 methods can be stored, and 5 steps can be set for each of them.
- > Timing function distillation: The distillation program will be closed automatically when the setting time is reached



● Safety

- > A safety heating bath with overheating and dry running protection
- > In case of a power outage, the electric lifting device removes the flask from the heating bath to prevent the safety issues and potential thermal damage to your sample
- > The shield is standard for all models. It can be removed by the operator and fitted beside the instrument
- > High vapor temperature protection, low vapor temperature protection and vapor temperature range settings



Display and operation

General Settings



Bath temperature settings

- > Bath temperature switch
- > Temperature settings
- > Pre-warm up switch (After the main power switch is turned on, the bath can be heated to a set temperature)

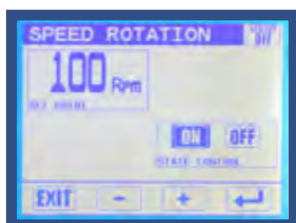

Rotation settings

- > Rotation switch
- > Speed settings

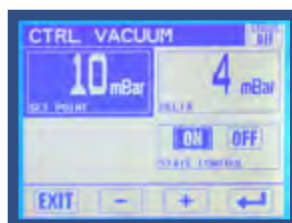

Vacuum settings

- > Vacuum switch
- > Vacuum settings
- > Vacuum Delta (Permissible vacuum fluctuation range and control valve opening and closing frequency)
- > If optional ST380 vacuum controller is present

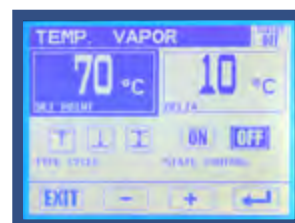

Vapor temperature monitoring and protection

- > Vapor temperature display
- > Max. vapor temperature settings
- > Min. vapor temperature settings
- > Vapor temperature range

Advanced settings

Unique function

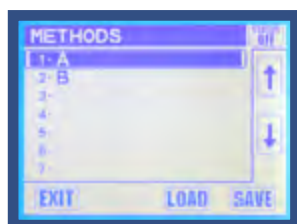

Method

Customers can save the current settings as a standard method, easy to quickly call in the future. Up to 21 methods can be stored



Function

- > Manual multistage distillation. At the end of each step, it need to be onfirmed by the operator, then move on to the next step. Up to 21 methods can be stored, and 5 steps can be set for each of them.
- > Automatic multistage distillation. At the end of each step, it automatically moves to the next step (Application examples: concentration). Up to 21 methods can be stored, and 5 steps can be set for each of them.
- > Timed distillation. When the time is over, the distillation will automatically end

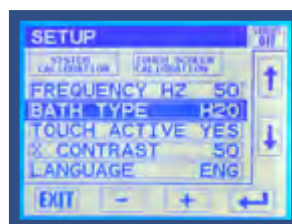

Setup

- > Frequency (50 / 60Hz)
- > Bath type (Water / Oil)
- > Touch active (Yes / No)
- > Contrast
- > Language

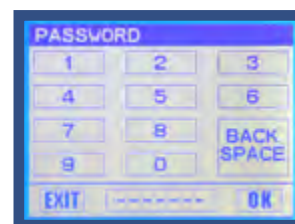

Password for calibration

- Bath temperature sensor
- Vapor temperature sensor
- Cooling temperature sensor
- Vacuum

Specifications

Technical data	Strike 385
Models	Slanting glassware, Vertical glassware (Vapor sinking), Vertical glassware (Vapor rising), Dry ice condensation type
Glassware	Standard or plastic-coated glassware
Rotation speed	20 to 280 rpm (150W induction motor)
Screen	3.5" monochromatic LCD touch screen
Sealing	The exclusive sealing system guarantees perfect vacuum tightness and anti-corrosiveness.
Connection	The easy clamp is made of highly resistant material which ensures a long life performance
Bath temperature	185°C (2 possible settings: water and oil)
Bath heater	1400W
Bath capacity	5 liters
Temperature stability	±0.2°C
Bath material	PTFE coated molded aluminum tank
Left and right moving distance	90mm
Draining	Removable bath for emptying
Stroke displacement	13cm, adjustable, and can be stopped at any position
Head angle adjustable	0~15°
Cooling surface	1500cm ²
Evaporating flasks	1000ml (optional 50 to 2000ml)
Collecting flasks	1000ml (optional 250 to 2000ml)
Weight	26,5 Kg (vertical version), 26 Kg (slanting version)
Overall dimensions	690x700x430mm (vertical version,HxDxL) 690x790x430mm (slanting version,HxDxL)
Voltage	230 V AC, 50/60Hz
Options	Vapor temperature probe, vacuum controller
Protective shield	Glassware lifting up possible with or without the protective shield
Other features	Powered glassware lifting up device with safety release (in case of power failure) Quick start/stop control and parameter selector

Models of Strike 385



STRIKE 385 M1 / M4
Slanting glassware



STRIKE 385 M2 / M5
Vertical glassware (Vapor sinking)



STRIKE 385 M3 / M6
Vertical glassware (Vapor rising)



STRIKE 385 M7
Dry ice condensation type

Configurations in standard glassware

Order Number	Model	Type	Voltage	Version
SQED160113	Strike 385 M1	Slanting glassware	220V	O
SQED160112	Strike 385 M2	Vertical glassware (Vapor sinking)	220V	V
SQED160111	Strike 385 M3	Vertical glassware (Vapor rising)	220V	U

Configurations in plastic coated safety glassware

Order Number	Model	Type	Voltage	Version
SQED160419	Strike 385 M4	Slanting glassware	220V	O/P
SQED160418	Strike 385 M5	Vertical glassware (Vapor sinking)	220V	V/P
SQED160417	Strike 385 M6	Vertical glassware(Vapor rising)	220V	U/P
SQED160420	Strike 385 M7	Dry ice condensation type	220V	C

NOTE: Other glassware versions are available upon specific request

Five steps to building up your rotary evaporator

Step 1



STRIKE285 / 385
Slanting glassware

STRIKE285 / 385
Vertical glassware (Vapor sinking)

STRIKE285 / 385
Vertical glassware (Vapor rising)

Rotary evaporator Strike285 / 385

- > Three sets of glassware available
- > Two kinds of glass materials available: Borosilicate glass / Borosilicate glass with safety coating
- > Evaporating flasks: 1000ml (optional 50~2000ml)
- > Collecting flasks: 1000ml (optional 250~2000ml)

Step 2



Recirculating chiller
-10 ~ +40°C

Recirculating chiller
-20 ~ +40°C

Chiller

* Various chillers available for different applications

	0.5-1 L	up to 2 L	
STRIKE285 / 385	1	2	3-4
Chiller	FL300	F500 FL601	F1000 FL1201

Step 3



C420 / C520
Vacuum pump

CSH420 / CSH520
Solvent Recovery Systems

CSC420 / CSC520
Vacuum solvent recovery system

Vacuum system

Different vacuum systems are optional according to different experimental requirements

	C series	CSH series	CSC series
Vacuum pump	●	●	●
Vacuum controller	○	○	●
Condensers	○	●	●
Separator	○	●	●
Collecting flasks	○	●	●

Step 4



ST280
Vacuum controller

ST380
Vacuum controller

DVR480
Vacuum controller

Vacuum controller

- > If a vacuum controller is selected, different vacuum can be controlled
- > ST280 and ST380 can display vacuum values on the screen of rotary evaporators
- > DVR480 can set and display the vacuum value directly.
- > CSC Vacuum solvent recovery system series already contain the vacuum controller.

Step 5

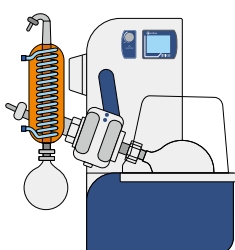

Possible to operate according to vapor temperature (if optional probe is present)

Temperature sensor

- > Possible to operate according to vapor temperature (if optional probe is present)
- > Strike285 can also display cooling water temperature (if optional probe is present)
- > Glass temperature sensor, corrosion resistant
- > Vapor temperature can be displayed on the screen of rotary evaporators

Vacuum pump, vacuum controller and vacuum solvent recovery system

Chemical Resistant Pump



Model	A410	A510	C410	C510	C520	C610
Max.power(W)	95	245	95	245	150	245
Max.vacuum(mbar)	13	8	13	8	8	2-4
Max.Flow Rate(L/min)	25	40	25	34	50	37
Outlet(mm)	10	10	10	10	10	10

The above are the specifications of 220V models. Suitable for STIRKE285/385



Vacuum solvent recovery system - CSH series

The inlet of the CSH System is connected to a segregation bottle, whereas the outlet is connected to a condenser, which is used to condensate and recover the solvent.

Model	CSH410	CSH510	CSH520
Build in Pump Type	C410	C510	C520
Power(W)	95	245	150
Ultimate Vacuum(mbar)	13	8	8
Max. Flow Rate(l/min)	25	34	50
Outlet Size(outer diameter in mm)	10	10	10
Order No.	900512	900513	900515
Suitable for	STIRKE285/385	STIRKE285/385	STIRKE285/385



CSH Series

Vacuum controller

Model	DVR480 / DVR480-Pro	ST280	ST380
Voltage	900414-1 / 900414-2	SQEF059422	SQEF059421
Voltage	100-240V, 50/60Hz	12VDC	12VDC
Displayed Vacuum Accuracy	0.1 mbar	1 mbar	1 mbar
Controllable Range	0.1~1000 mbar	1~1000 mbar	1~1000 mbar
Measurement Accuracy	0.25%FS / 0.1%FS	1%FS	1%FS
Display	LED	Display on the Strike 280	Display on the Strike 380
Control Mode	On-Touch	Controlled by Strike 280	Controlled by Strike 380
Timer / Program	Yes / Up to 5 Steps	-	-
Pressure Release Feature	Yes	No	No
Electrical Control of the Pump	Yes	Yes	Yes
Protection Category	IP40	IP40	IP40
Corrosion resistance	All parts that come into contact with gases are made of PTFE or highly durable ceramic to ensure the resistance to various acid, base, or organic solvent gases.		
Suitable for	STIRKE285/385	STIRKE285	STIRKE385



DVR 480 Series



ST280 / ST380

Vacuum solvent recovery system - CSC series

The inlet of the CSC System is connected to a segregation bottle, whereas the outlet is connected to a condenser, which is used to condensate and recover the solvent. In addition, the system contains a vacuum controller to set, display, and control the vacuum.

Fully automated vacuum generation system comprising chemical resistant diaphragm vacuum pump, base plate, high performance condenser, segregation bottle, vacuum control device, valves and control unit.

Model	CSC 410	CSC 510	CSC 520
Build in Pump Type	C410	C510	C520
Power(W)	95	245	150
Ultimate Vacuum(mbar)	13	8	8
Max. Flow Rate(l/min)	25	34	50
Outlet Size(outer diameter in mm)	10	10	10
Order No.	900522	900523	900525
Suitable for	STIRKE285/385	STIRKE285/385	STIRKE285/385



CSC Series

Note: CSC Solvent Recovery Systems already contain a vacuum controller.

Accessories and spare parts



GS1 / GS4



GS2 / GS5



GS3 / GS6



GS7

Glassware set

Order No.	Type	Description
SQED159113GS	GS1	Glassware set, Slanting type, including SQFY015937 evaporating flask, SQEF059799 condenser, SQUA015796 collection flask, FLMM016694 Clamp, PTFE refill pipe and valve, 8mm vacuum tubing, cooling water tubing etc.
SQED159112GS	GS2	Glassware set, Vapor sinking, including SQFY015937 evaporating flask, SQEF059796 condenser, SQUA015796 collection flask, FLMM016694 Clamp, PTFE refill pipe and valve, 8mm vacuum tubing, cooling water tubing etc.
SQED159111GS	GS3	Glassware set, Vapor rising, including SQFY015937 evaporating flask, SSQEF059794 condenser, SQUA015796 collection flask, FLMM016694 Clamp, PTFE refill pipe and valve, 8mm vacuum tubing, cooling water tubing etc.
SQED159419GS	GS4	Glassware set, Vapor sinking, including SQFY015937 evaporating flask, SQEF059798 condenser, SQUA015789 collection flask, FLMM016694 Clamp, PTFE refill pipe and valve, 8mm vacuum tubing, cooling water tubing etc.
SQED159418GS	GS5	Glassware set, Vapor sinking, including SQFY015937 evaporating flask, SQEF059797 condenser, SQUA015789 collection flask, FLMM016694 Clamp, PTFE refill pipe and valve, 8mm vacuum tubing, cooling water tubing etc.
SQED159417GS	GS6	Glassware set, Vapor rising, including SQFY015937 evaporating flask, SQEF059795 condenser, SQUA015789 collection flask, FLMM016694 Clamp, PTFE refill pipe and valve, 8mm vacuum tubing, cooling water tubing etc.
SQED159420GS	GS7	Glassware set, Dry ice condensation type, including SQFY015937 evaporating flask, SQEF059793 condenser, SQUA015796 collection flask, FLMM016694 Clamp, PTFE refill pipe and valve, 8mm vacuum tubing, cooling water tubing etc.



Slanting type



Vapor sinking



Vapor rising



Dry ice condensation type

Condenser

Order No.	Order No.	Description
High Quality borosilicate glass	Plastic coated safety glassware	
SQEF159799	SQEF159798	Slanting type
SQEF159796	SQEF159797	Vapor sinking
SQEF159794	SQEF159792	Vapor rising
SQEF159793		Dry ice condensation type

Borosilicate glass evaporating flask 29/32

Order No.	Order No.	Volume	Connection
High Quality borosilicate glass	Plastic coated safety glassware		
SQFY051171	SQFY051171S	50mL	NS29/32
SQFY015948	SQFY015948S	100mL	NS29/32
SQFY015949	SQFY015949S	250mL	NS29/32
SQFY015941	SQFY015941S	500mL	NS29/32
SQFY015937	SQFY015937S	1000mL	NS29/32
SQFY015946	SQFY015946S	2000mL	NS29/32



Evaporating flasks for powders

Order No.	Order No.	Volume	Connection
High Quality borosilicate glass	Plastic coated safety glassware		
SQFY146060	SQFY146060S	500mL	NS29/32
SQFY146062	SQFY146062S	1000mL	NS29/32
SQFY146061	SQFY146061S	2000mL	NS29/32



Borosilicate glass collecting flask 35/20

Order No.	Order No.	Volume	Connection	Clamp
High Quality borosilicate glass	Plastic coated safety glassware			
SQUA015797	SQUA015788	250mL	35/20 (Spherical Joint)	FLMM016694
SQUA015798	SQUA015791	500mL	35/20 (Spherical Joint)	FLMM016694
SQUA015796	SQUA015789	1000mL	35/20 (Spherical Joint)	FLMM016694
SQUA015792	SQUA015790	2000mL	35/20 (Spherical Joint)	FLMM016694



Borosilicate glass adapter for collecting flasks

Order No.	Inner joint	Outer joint	Clamp
SQFW129300	NS29/32	4×NS14/23	FLMU016723
SQFW129301	NS29/32	4×NS19/32	FLMU016722
SQUA162434	NS29/32	3×NS29/32	FLMU016720
SQUA162435	NS29/32	4×NS29/32	FLMU016720



Borosilicate glass adapter for connection / extension

Order No.	Inner joint	Outer joint	Clamp
SWAD160001	NS29/32	NS24/29	FLMU016721
SWAD160002	NS29/32	NS19/26	FLMU016722
SWAD160003	NS29/32	NS14/23	FLMU016723



Anti-sprinkling bubble in borosilicate glass

Order No.	Bubble volume	Inner joint	Outer joint	Clamp
SQFW126450	50mL	NS29/32	NS29/32	FLMU016720
SQFW126451	100mL	NS29/32	NS29/32	FLMU016720
SQFW126452	100mL	NS29/32	NS24/29	FLMU016721
SQFW126453	250mL	NS29/32	NS29/32	FLMU016720
SQFW126454	250mL	NS29/32	NS24/29	FLMU016721



PT100 probe

Order No.	Description
SQEF059420	complete with glass trap for vapour temperature monitoring



Joint clip, plastic

polymethylene acetal resin snap on and off with ease. They will not scratch the glass and are resistant to concentrated alkalis and dilute acids. usable temperature range: -40°C to 140°C . Slight positive pressure only. For above 300mbar

Order No.	Description
FLMU016720	JRS-7598-29 For 29/32, pk/1
FLMU016721	JRS-7598-24 For 24/29, pk/1
FLMU016722	JRS-7598-19 For 19/26, pk/1
FLMU016723	JRS-7598-14 For 14/23, pk/1



Discharge valve, vapor tube, sample fling tube

Order No.	Description
SQEF162449	Discharge valve
SQEF059795	Vapor tube



Tightening clamp

Order No.	Description
FLMM016694	Tightening clamp for flasks with spherical joint to fix the collecting flask



Sleeves, PTFE

Designed for use with inner member regular joints with only slight mismatch. Treated on inner surface so that it may be cemented to glass. Sleeves may also be used uncemented to replace lubricant at low pressure differentials.

Order No.	Description
KAMY011542	7551-14 For 29/42, pk/1
KAMY011544	7551-12 For 24/29, pk/1
KAMY011546	7551-09 For 19/22, pk/1
KAMY011547	7551-06 For 14/23, pk/1



Rubber vacuum resistant tube, to connect condensers with chillers

Order No.	Description
168001-01	Outer diameter: 14mm, Inner diameter: 8mm, Thickness: 3mm, Length: 1m
016.1712.01	Outer diameter: 12mm, Inner diameter: 10mm, Thickness: 1mm, Length: 1m



Tube clamp

Order No.	Description
8 970 480	2 Tube clamps, size 1, tubing 8 mm inner dia.
8 970 481	2 Tube clamps, size 2, tubing 10 - 12 mm inner dia.



ST20

The highest performance proposal
For your evaporation processes!

3 Options

Standard rotary evaporator
ATEX version
Continuous Rotary Evaporator
Each option with 6L, 10L and 20L configurations

Following on Industrial Relation
System Design Concept



Vertical glassware (Vapor sinking)

ST20 - Large-Capacity Rotary Evaporator



ST20 has both industrial and laboratory rotary evaporation features. It meets all the process needs by using borosilicate glass and PTFE permitting aggressive substance treatment. The plant allows for evaporation of volatile components (low boiling point) so as to separate them from the residual ones (high boiling point) due to the difference of their boiling points. Easy and totally safe startup, check and stop procedures of the process: ST20 is provided with a transparent protection shield for the evaporation flask and the thermostatic bath.



① **Heating bath**
The heating bath is lifted by means of a hydraulic system which, in case of power failure, goes automatically down to avoid fluid overheating and bumping.

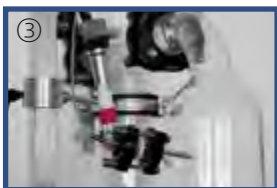

② **Sealing system**
A great feature of ST20 is its sealing system made of self-lubricating material which guarantees perfect vacuum tightness. This sealing system does not require any maintenance.



③ **Pressure and temperature**
ST20 runs under atmospheric pressure conditions or vacuum. It guarantees perfect vacuum tightness up to 5 mbar. The perfect sealing up to 5 mbar allows for reduced process time due to low evaporation temperature of the fluid. The thermostatic bath can run both with water and oil, and the maximum temperature can reach 150°C ; it also permits evaporation of any solvent under atmospheric pressure conditions. The heating bath is supplied with 3KW electric heaters.

④ **Measurement, visual display and recording of the following parameters:**

- > Bath pre-set and real temperature
- > Vapor pre-set and real temperature
- > Pre-set and real rotation speed
- > Pre-set and real vacuum reading and setting

Display and Operation

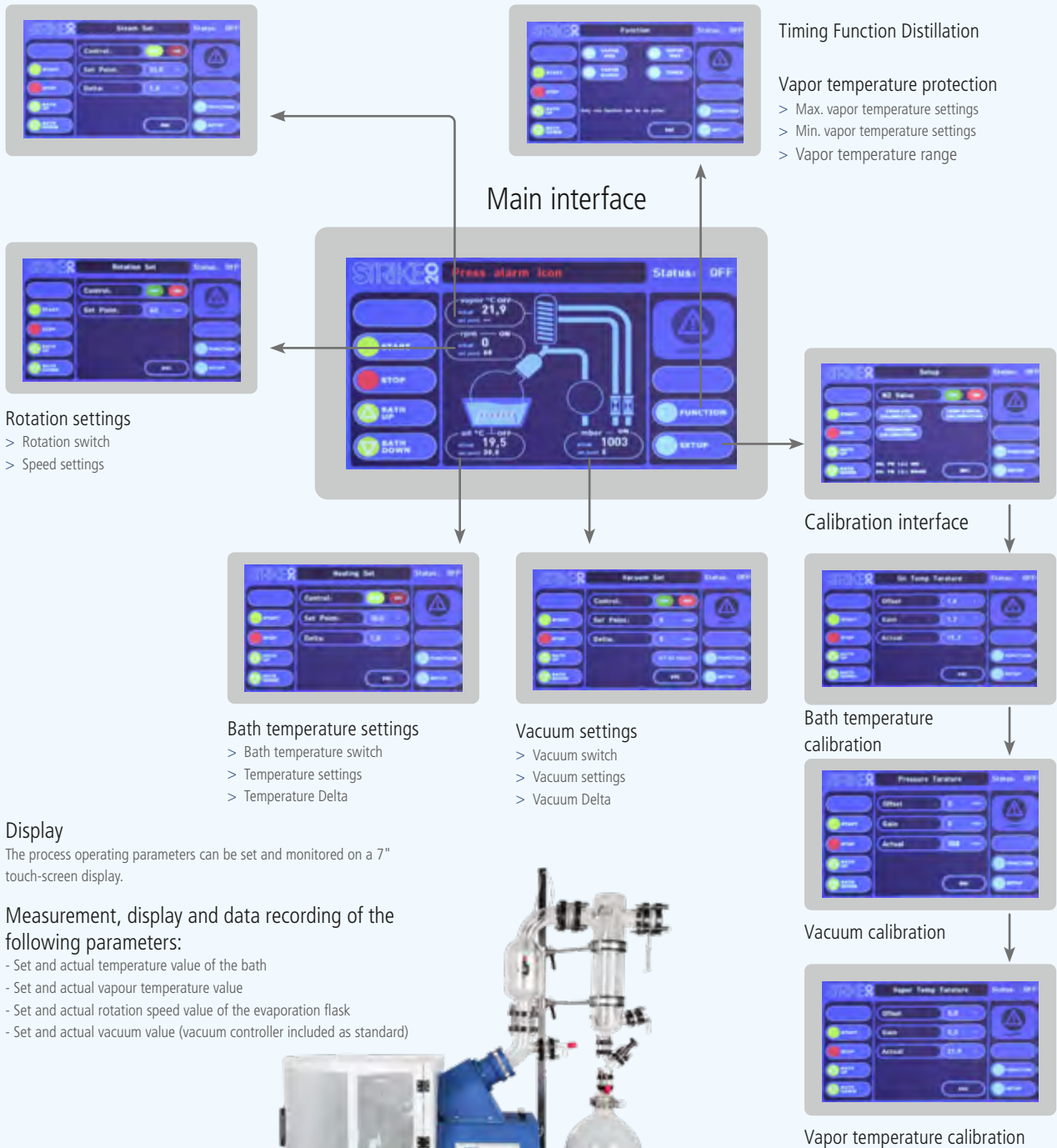

Display

The process operating parameters can be set and monitored on a 7" touch-screen display.

Measurement, display and data recording of the following parameters:

- Set and actual temperature value of the bath
- Set and actual vapour temperature value
- Set and actual rotation speed value of the evaporation flask
- Set and actual vacuum value (vacuum controller included as standard)



STQ

Vertical glassware (Vapor sinking)

Technical Features

Heating bath	
Working range °C	ambient ... 150
Accuracy °C	± 2
Resolution °C	0.1
Set point	YES (1°C step)
Type of control	PID
Maximum oscillation during checkout °C	± 3
Power resistor KW	3
Heater power density	≤3W/cm ²
Over-temperature protection	YES
Temperature sensor	PT100
Filling level	Manual
Vapour temperature	
Working range °C	ambient ... 150
Accuracy °C	± 2
Resolution °C	0.1
Temperature sensor	PT100
Rotation	
Working range rpm	10-150
Accuracy rpm	± 2
Rotation speed reading	YES
Resolution rpm	1
Vacuum control	
Working range mbar	8~atmospheric
Accuracy mbar	±5mbar
Resolution mbar	1
Absolute vacuum reading	√
Display	Digital
Vacuum setting	√
Lifting system	
On/off	√
Electric driven	√
Interface	
Export data	√
Remote control	√
Alarms and controls	
Heating bath overheating	√
Bath temperature exceeding set point	√
Soft start rotation	√
Rotation speed monitoring	√
Safety status (rotation, lifting, heating=off)	√
Evaporation flask protection	√
Glassware	
20 lt evaporation flask	√
10 lt evaporation flask	√
6 lt evaporation flask	√
Collecting flasks: 2x6 lt or 1x10lt	√
Glassware configuration	Descending, reflux, customized
General features	
Cooler exchange surface (sqm)	0.5
Over-pressure protection	√
Protection with rupture disc	√
Quick closing	√
Dimensions (WxDxH mm)	1240x580x2060
Power supply	230V, 3.2 kW
Weight	160Kg
Vapours cycle maximum temperature	√
Vapours cycle minimum temperature	√
Vapours cycle Temp range	√
Receipt/methods in memory	√
Recipes customization	√
Data acquisition on PC	√
Remote control	√
Bath lowering in case of alarm	√
Optional accessories	
Plastic coated glassware	√
Evaporation flask protection shield	√



Vertical glassware (Vapor rising)

Applications

- Distillation(continuous and discontinuous)
- Solvent recycling
- Reflux process reactions
- Component drying
- Fine chemical synthesis
- Crystallization
- Extractions
- Purifications
- R&D studies
- Scale-down processes

Industries

- Pharmaceutical
- Chemical
- Cosmetic
- Herb extraction
- Food
- Research
- Petrochemical

Order information

Order No.	Configuration
SQFY079737	ST20 descending glassware (Vapor sinking), 20L evaporating flask, 1x10L collecting flask
SQFY079738	ST20 descending glassware (Vapor sinking), 20L evaporating flask, 2x6L collecting flasks
SQFY079735	ST20 reflux glassware (Vapor rising), 20L evaporating flask, 1x10L collecting flask
SQFY079736	ST20 reflux glassware (Vapor rising), 20L evaporating flask, 2x6L collecting flasks

Accessories for ST20

Order No.	Description
SQFW080270	Stainless steel trolley for evaporating flask handling
SQFY080951	6L Evaporation vessel for ST20
SQFY080952	10L Evaporation vessel for ST20
SQFY080953	20L Evaporation vessel for ST20
SQFY080954	6L Plastic-coated collecting vessel for ST20
SQFY080955	10L Plastic-coated collecting vessel for ST20



ST20 CRE

Continuous Distillation Rotary Evaporator ST20 CRE

Reliable PLC controlling system

With all the basic functions of Standard ST20 rotary evaporator
Automatic continuous distillation function included



Order information of ST20 CRE

Order No.	Model	Configuration
SQFU079747	ST20 CRE	ST20 CRE descending glassware (Vapor sinking), 20L evaporating flask, 1x10L collecting flask, 4 x Liquid level sensors, Solenoid valve set
SQFU079745	ST20 CRE	ST20 CRE reflux glassware (Vapor rising), 20L evaporating flask 1x10L collecting flask, 4 x Liquid level sensors, Solenoid valve set

● Parameter

- > Bath temperature: RT+5~+150°C
- > Rotation speed: 10~150rpm
- > Vacuum: 8mbar

● Display

- > Touch screen
- > Bath temperature, Speed, Vacuum, Vapor temperature and safety features
- > The distillation mode can be switched by one button

● Process mode

- > Batch distillation (Conventional mode)
- > Continuous distillation (Cascade mode)

● Glassware

- > Vapor sinking type
- > Vapor rising type
- > Evaporating flask: 6/10/20L
- > Collection flask: 2x6L or 1x10L

● Liquid level sensors

- > Monitoring the liquid level in evaporation flasks
- > Monitoring the liquid level in collection flasks
- > Low level alarm for the reservoir of solutions which have to be evaporated;
- > High level alarm for the reservoir of the distilled solvent

● Solenoid valve set

- > Vacuum control valve
- > Nitrogen gas valve to have inert atmosphere protection for sample
- > Refill valve
- > Discharge valve

● Safety

- > Over temperature protection
- > Automatic liquid level monitoring and alarm function
- > Standard protective cover

ST20 ATEX

Large-Capacity Rotary Evaporator Explosion-proof type - ST20 ATEX

ATEX version for process and environment safety



For more detailed information, please contact WIGGENS

Order information ST20 ATEX

Order No.	Model	Configuration
SQFU079757	ST20 ATEX	ST20 ATEX descending glassware (Vapor sinking), 20L evaporating flask 1x10L collecting flask
SQFU079758	ST20 ATEX	ST20 ATEX descending glassware (Vapor sinking), 20L evaporating flask, 2x6L collecting flasks
SQFU079755	ST20 ATEX	ST20 ATEX reflux glassware (Vapor rising), 20L evaporating flask 1x10L collecting flask
SQFU079756	ST20 ATEX	ST20 ATEX reflux glassware (Vapor rising), 20L evaporating flask, 2x6L collecting flasks

ST20 ATEX version is in compliance with the ATEX European Directives that regulate explosion-proof manufacturing materials. ST20 ATEX is T3 or T4 certificated. T3 or T4 protection level can be chosen according to the applications needed.

ST20 ATEX Accessories

Order No.	Configuration
SQFY080951	6L Evaporation vessel for ST20 CRE / ST20 ATEX
SQFY080952	10L Evaporation vessel for ST20 CRE / ST20 ATEX
SQFY080953	20L Evaporation vessel for ST20 CRE / ST20 ATEX
SQFY080954	6L Plastic-coated collecting vessel for ST20 CRE / ST20 ATEX
SQFY080955	10L Plastic-coated collecting vessel for ST20 CRE / ST20 ATEX
SQFW080270	Aluminium trolley for evaporating flask handling, for ST20 CRE / ST20 ATEX

STRIKE 100 - Industrial Rotary Evaporator

STRIKE100 is a large-capacity rotary evaporator designed for industrial plants. It meets all the process needs by using borosilicate glass and PTFE permitting aggressive substance treatment. The unit works under vacuum or atmosphere conditions. The rotation of the 50 or 100 Lt evaporation flask in the thermostatic bath results in forced convection and homogenous distribution of the product, thus preventing sedimentation. Moreover, it ensures high evaporating exchange surface. The sealing system guarantees the perfect vacuum tightness and maintenance-free operation. Possibility to customize glassware for client needs.

Applications

- Distillation (continuous and discontinuous)
- Solvent recycling
- Reflux reaction process
- Component drying
- Fine chemical synthesis
- Crystallization
- Extractions
- Purifications
- Scale-up processes

Fields

- Pharmaceutical
- Chemical
- Cosmetic
- Herb extraction
- Petrochemical
- Food

STRIKE8

The highest performance proposal
For your evaporation processes!



Total safety system

The industrial safety rotary evaporators are able to safeguard the user from any risk during work. The thermostatic bath is covered by a transparent shield providing the operator with utmost protection from glass breaking and spray at high temperature. The thermostatic bath and the protective shield are lifted by means of a hydraulic system electronically controlled. An automatic system lowers the thermostatic bath when power failure, door opening and overheating occur. It is also inserted on glassware a brake disc in order to avoid sudden overpressure.

Vacuum sealing system

A great feature of these rotary evaporators is its sealing system made of self-lubricating material which guarantees perfect vacuum tightness. This sealing system does not require any maintenance.

Heating bath

The heating bath is lifted by means of a hydraulic system which, in case of power failure or doors opening, goes automatically down to avoid fluid overheating and the process will immediately stop. Electric heater is enhanced to 8Kw to ensure continuous evaporation of the product even in the worst conditions.

Display

The process operating conditions can be set and displayed: any value error or anomalous temperature will block the electric power. For version STRIKE100 ATEX is a "LCD display anti-reflection coating glass panel". For version STRIKE100 is a graphical color display 7" touch-screen.

Electronic controller

STRIKE100 & STRIKE100ATEX are fully controlled by a PLC (Programmable Logic Controller) which allows for controlling the parameters as well as setting them directly by means of the keys.

Clients could acquire on an external PC through serial communication all the process parameters through special software for data acquisition and management. Clients could remotely control the instrument from an external PC via serial communication. Clients could save and recall up to 20 methods or "recipes" work that the customer can customize at any time (NOT ON ATEX VERSION). In addition, the instrument has control algorithm that allow you to finish the process of evaporation / distillation or separation of solvents automatically by reading the temperature of the vapors.



Technical features

Thermic Bath	
Working range °C	[0~150]
Accuracy °C	± 2
Resolution °C	0.1
Set point	YES (1°C step)
Type of control	PID
Maximum oscillation during checkout °C	± 3
Power resistor KW	8
Heater power density	3W/cm ²
Over-temperature protection	YES
Temperature sensor	Three-wire PT100
Level sensor	YES
Filling level	Yes -Manual
Vapour Temperature	
Working range °C	[0~150]
Accuracy °C	± 2
Resolution °C	0.1
Temperature sensor	Three-wire PT100
Rotation	
Working range Rpm	[5~100]
Accuracy rpm	± 2
Rotation speed reading	YES
Resolution rpm	1
Engine 0,18KW, 380Vac	YES
Vacuum Control	
Working range mbar	[0~1000]
Accuracy mbar	±5mbar
Resolution mbar	1
Absolute vacuum reading	YES
Display	Digital
Vacuum regulation	YES
Lifting	
Lifting control ON/OFF	YES
Hydraulic lifting	YES
Interface	
PLC controlled	YES
Export data interface	YES
Remote control interface	YES
Alarms	
Thermal bath overheat	YES
Bath temperature exceeding set point	YES
Soft start rotation	YES
Rotation speed monitoring	YES
Security status (rotation, lifting, heating=off)	YES
Evaporation flask protection opening	YES
General	
100Lt evaporation flask	YES
50Lt evaporation flask	YES
20L evaporation flask	YES
20Lt collecting flask	2
cooler exchange surface (mq)	0.6/1.4/custom
Over-pressure protection	YES
Protection with rupture disc	YES
Quick closing	YES
ATEX certification	YES
Dimensions (WxDxH mm)	1830x890x2110
Operation	
vapours cycle maximum temperature	YES
vapours cycle minimum temperature	YES
vapours cycle Temp range	YES
receipt/methods in memory	YES
recipes customization	YES
Data acquisition on PC	YES
Remote Control	YES
lowering bath in case of alarm	YES
Optional	
Plastic coated glassware	



Parameters measurement, visual display and recording of the following:

- Bath pre-set and real temperature
- Vapor pre-set and real temperature
- Pre-set and real rotation speed
- Pre-set and real vacuum reading and setting

Order information

Strike 100	Order No.
100L version	
100lt reflux glassware 1.43m ² 2x20L	SQFU082237
100lt reflux glassware 1.43m ² 1x20L	SQFU083070
100lt descending glassware 100lt 1.43m ² 2x20L	SQFU081873
100lt descending glassware 100lt 1.43m ² 1x20L	SQFU083071

50L version	
50lt reflux glassware 0.6m ² 2x20L	SQFU083073
50lt reflux glassware 0.6m ² 1x20L	SQFU081309
50lt descending glassware 0.6m ² 2x20L	SQFU083074
50lt descending glassware 0.6m ² 1x20L	SQFU083075

Strike 100 ATEX	Order No.
100L version	
100lt reflux glassware 1.43m ² 2x20L	SQFU069848
100lt reflux glassware 1.43m ² 1x20L	SQFU069849
100lt descending glassware 100lt 1.43m ² 2x20L	SQFU069850
100lt descending glassware 100lt 1.43m ² 1x20L	SQFU069851

50L version	
50lt reflux glassware 0.6m ² 2x20L	SQFU083084
50lt reflux glassware 0.6m ² 1x20L	SQFU083085
50lt descending glassware 0.6m ² 2x20L	SQFU080799
50lt descending glassware 0.6m ² 1x20L	SQFU083086

*Strike 100 ATEX version is in compliance with the ATEX European Directives that regulate explosion-proof manufacturing materials.

Strike 100 ATEX is T3 or T4 certificated. T3 or T4 protection level can be chosen according to the applications needed.

Accessories for Strike 100

Description	Order No.
Aluminum trolley for evaporating flask handling	SQFW039025
50L Evaporation vessel for Strike 100	SQEG034290
100L Evaporation vessel for Strike 100	SQEG034291
20L Plastic-coated collecting vessel	SQEG036866

Chemical Resistant Diaphragm Pumps For industrial rotary evaporator

High chemical resistant

All wetted parts of Chemvak C series pump is made of PTFE material which is ideal for extremely aggressive / corrosive gases and vapors.

Model	C900E	C920Z	C960T	C2000T
Max. vacuum (mbar)	30	8	2	8
Max. Flow Rate (L/min)	90	70	60	145
Outlet (mm)	10	10	10	10
Order No.	169900-22	169920-22	169960-22	W1032002
Suitable for	ST20	ST20	ST20	STRIKE 100



C2000T

Recirculating Coolers

- > The compact FL models are suited for a wide variety of cooling tasks.
- > Easy filling from above
- > Feed pressure indicator and level indicator (all models)
- > Large compensation volume
- > Circulating pumps designed for continuous operation
- > Permissible return temperature up to +80 °C
- > Low liquid level protection with visual and acoustic signals
- > May be used with water, water-glycol, thermal bath fluid
- > Overload protection for pump motor and cooling machine

JULABO Order No.	Model	Working temp. range	Temp. stability	Cooling capacity (kW)					Pump capacity Flow rate/pressure		Filling volume liters	Suitable for
				20	10	0	-10	-20°C	L/min	bar		
9 663 025	FL2503	-20~40	±0.5	2.5	2.2	1.5	--	0.55	40	0.5-3.0	24~30	ST20
9 663 040	FL4003	-20~40	±0.5	4.0	3.4	2.4	--	0.65	40	0.5-3.0	24~30	ST20



Rotary evaporator



Continuous Distillation
Rotary Evaporator

Chemical Resistant
Diaphragm Pump

Recirculating Cooler

Application guide

Model	Collection rate ml/h	Chemicals	Cooling capacity W	Chiller	Vacuum pump
STRIKE280 STRIKE300	50	Toluene	5.2	F250, FL300	C410, C510
		Acetone	7.3	F250, FL300	C410, C510
		Absolute alcohol	11.4	F250, FL300	C410, C510
		Water	37.6	F250, FL300	C410, C510
	100	Toluene	10.4	F250, FL300	C410, C510
		Acetone	17.6	F250, FL300	C410, C510
		Absolute alcohol	22.8	F250, FL300	C410, C510
		Water	75.2	F250, FL300	C410, C510
	250	Toluene	26.0	F250, FL300	C410, C510
		Acetone	36.5	F250, FL300	C410, C510
		Absolute alcohol	57.0	F250, FL300	C410, C510
		Water	188.0	F250, FL300	C410, C510
STRIKE20	500	Toluene	52.0	F250, FL300	C410, C510
		Acetone	73.0	F250, FL300	C410, C510
		Absolute alcohol	114.0	F250, FL300	C410, C510
		Water	376.0	F500, FL601	C410, C510
	1000	Toluene	104.0	F250, FL300	C410, C510
		Acetone	176.0	F250, FL300	C410, C510
		Absolute alcohol	228.0	F250, FL300	C410, C510
		Water	752.0	FL1701	C410, C510
	2000	Toluene	208.0	F250, FL300	C410, C510
		Acetone	252.0	F500, FL300	C410, C510
		Absolute alcohol	456.0	F500, FL601	C410, C510
		Water	1504.0	FL1701	C410, C510
6000	Toluene	624.0	FL1701	C610, C960T	
	Acetone	1056.0	FL1701	C610, C960T	
	Absolute alcohol	1368.0	FL1701	C610, C960T	
	Water	4512.0	FL7006	C960T	
10000	Toluene	1040.0	FL1701	C610, C960T	
	Acetone	1760.0	FL2503	C610, C960T	
	Absolute alcohol	2280.0	FL2503	C610, C960T	
	Water	7520.0	FL11006	C960T	
20000	Toluene	2080.0	FL2503	C610, C960T	
	Acetone	2520.0	FL2503	C610, C960T	
	Absolute alcohol	4560.0	FL7006	C960T	
	Water	15040.0	FL20006	C960T	



$Q = \text{flow rate} \times \text{heat of vaporization} \times \text{density}$

Q = heat load in Watt

flow rate: in ml/hour

heat of vaporization: in Kcal/g

density: in g/ml

Example

Collecting 300 ml of methylene chloride in 30 minutes

1. Convert volume to weight: 300 ml x density of 1.33 g/ml = 399 g

2. Convert minutes to hours: 399 g in 30 min = 798 g/hr

3. Multiply by the latent heat of vaporization: 798 g/hr x 89 cal/g = 71022 cal/hr

4. Divide by 1000 to get Kcal: 71022 / 1.000 = 71,022 kcal/hr

5. Multiply by 1.16 to get Watts: 71,022 x 1.16 = 82 Watt

Add a security factor of at least 20% for loss of cooling capacity due to high ambient, long tubing, etc.: 82 x 1.2 = 98 Watt

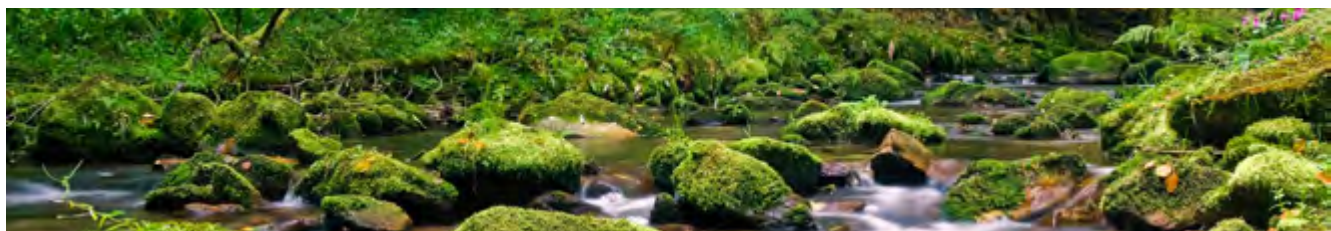



Vacuum Pump
Vacuum Solvent Recovery System
Vacuum Meter And Controller

Vacuum Pump

The ability to handle difficult and different vacuum challenges quickly.

Wiggins is your general laboratory companion and provides products that can be used in all kinds of laboratory environments. ChemVak is a product line in vacuum technology offering an extensive range of vacuum pumps for all applications. Including :



Chemical resistant diaphragm vacuum pumps which can be used in the chemical, pharmaceutical, petrochemical and other industries

Chemical resistant diaphragm pump
Frequency conversion chemical resistant vacuum pump



Chemical resistant diaphragm pump

Vacuum solvent recovery which can be used to get right vacuum conditions for various application



Vacuum Solvent recovery system



Oil-free piston vacuum pump, no pollution, no need for oil changes

Oil-free piston vacuum pump

Oil-sealed rotary vane vacuum pumps are widely used traditional vacuum pumps in research and production



Rotary vane vacuum pump



Vacuum pump selection guide

Before selecting a vacuum pump, please let us introduce a few basic concepts about vacuum.



▶ Vacuum

The degree of gas content in a vacuum state is usually expressed by the vacuum. The value read from the vacuum gauge is called the degree of vacuum. The vacuum value is the value that indicates that the actual value of the system pressure is lower than the atmospheric pressure. The value shown on the gauge is also called the gauge pressure, usually called the ultimate relative pressure. That is: Vacuum = atmospheric pressure - absolute pressure (atmospheric pressure is generally taken 1013.25mbar, the ultimate vacuum of the oil-free piston pump can reach about 30mbar, the ultimate vacuum of the chemical resistant diaphragm pump can reach 1mbar, and the ultimate vacuum of the rotary vane oil pump is about 0.0004mbar.



▶ Ultimate relative pressure

The relative pressure is how much lower the measured internal pressure is than the "atmospheric pressure", indicating that the actual value of the system pressure is lower than the value of atmospheric pressure. Since the air inside the container is pumped, the pressure inside the container is always lower than the pressure outside the container. Therefore, when using relative pressure or gauge pressure, the value must be preceded by a negative sign, indicating that the internal pressure of the container is lower than the external pressure.



▶ Ultimate absolute pressure

Absolute pressure refers to how much higher the measured internal pressure is than "theoretical vacuum (theoretical vacuum pressure value is 0Pa)". The object it compares is the absolute vacuum pressure value of the theoretical state. Due to technological limitations, we cannot pump the internal pressure to the absolute vacuum value of 0Pa in any case. Therefore, the vacuum value drawn by the vacuum pump is higher than the theoretical vacuum value. So when expressed in absolute vacuum, there is no negative sign in front of the value.



▶ Pumping speed

The pumping speed is a measure of the pumping speed of the vacuum pump. The general unit is expressed in L/min and m³/h. It is a parameter to make up for the air leakage rate. It is not difficult to understand, in theory, when pumping a container of the same volume, why is it easy for a vacuum pump with a large pumping capacity to pump the vacuum we need, while a vacuum pump with a small pumping capacity is so slow or even unable to pump the vacuum we want? Because It is always impossible for the pipeline or container to be absolutely air-free, and the large amount of air extraction makes up for the reduction of the vacuum degree caused by the air leakage, so the air volume can easily be pumped to the ideal vacuum value. It is suggested here that when the theoretical pumping capacity is calculated, we try to choose a vacuum pump with a higher pumping capacity. The specific calculation formula of the pumping volume will be introduced below.



After understanding the basic parameters of vacuum pumps such as vacuum degree, absolute pressure and relative pressure, we can enter the formal selection of vacuum pumps.



The required vacuum of the experimental process

The working pressure of the vacuum pump should meet the working pressure requirements of the process. The vacuum degree of the chemical resistant diaphragm pump should be half to an order of magnitude higher than the vacuum degree of the vacuum equipment. The vacuum must be at least 50mbar-10mbar), and the rotary vane oil pump must be an order of magnitude higher than the vacuum equipment.



The required pumping speed of the experimental process

The vacuum pump requires the pumping rate (that is, the ability of the vacuum pump to discharge gas, liquid, and solid under its working pressure), the general unit: m³/h, L/min, L/s, etc. The specific calculation method can refer to the following formula to calculate and select by yourself. Of course, the selection of vacuum pumps is a comprehensive process involving relevant experience and other factors.

$$S=(V/t) \times \ln(P1/P2)$$

S is the pumping rate of the vacuum pump (L/s)

V is the volume of the vacuum chamber (L)

t is the time required to reach the required vacuum (s)

P1 is the initial pressure (Pa)

P2 is the required pressure (Pa)



Determine the composition of the gas being pumped

- > 1- If the pumped object is gas, liquid or particles, if the pumped gas contains water vapor or a small amount of particles and dust and other impurities, carefully choose the rotary vane vacuum pump. If the vacuum degree is high, a filter device should be added. Only by filtering can the rotary vane vacuum pump be used as the vacuum obtaining equipment.
- > 2- Please let us know if the pumped object is corroded (acidic or alkaline, what is the pH value?). If the gas contains acid-base corrosion or organic corrosion, it should be filtered or neutralized to choose the rotary vane vacuum pump. If the vacuum meets the requirements for use, it is recommended to use an anti-corrosion diaphragm pump.
- > 3- If the pumped object contaminates rubber or oil? Corresponding vacuum equipment should be selected for different pumped media. If the gas contains a large amount of vapor, particles, and corrosive gas, it should be considered in the intake of the pump. Install the corresponding auxiliary equipment on the pipeline, such as condenser, filter, etc. (contact WIGGENS for details).
- > 4- If the noise and vibration of the vacuum pump have any influence.

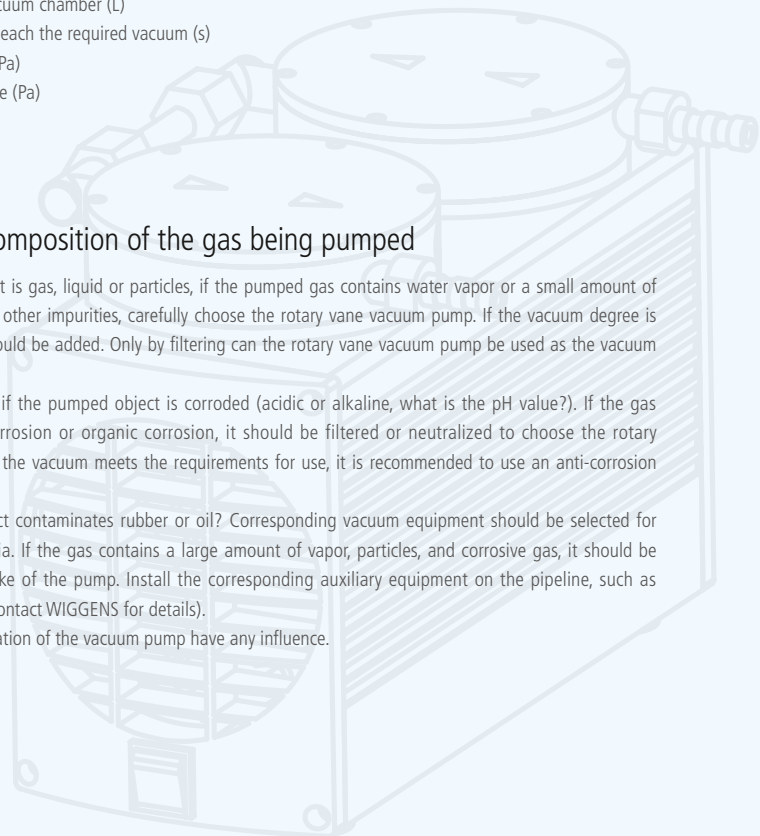

Application Guide

Application	Picture	Description	Pump speed / Vacuum	Recommended vacuum pump
Conventional vacuum requirements		Compact, portable, with certain corrosion resistance	25L/min 13mbar	A410 
Vacuum filtration system		The filtered sample is non-corrosive	34L/min 100mbar	V400 
		The filtered sample is corrosive and requires high corrosion resistance of the vacuum pump	34L/min 120mbar	C400 
Glass vacuum dryer		It is recommended to use a chemical resistant diaphragm vacuum pump. In addition, a vacuum gauge and a vacuum regulating valve are also required	22L/min 100mbar	C410 
Vacuum drying oven		The samples are usually aqueous, acidic or alkaline solutions, so chemical resistant diaphragm vacuum pumps are often recommended	37L/min 2-4mbar	C920Z 
Vacuum centrifugal concentrator		Chemical resistant diaphragm vacuum pumps usually do not require maintenance, and the ultimate vacuum is only 1-2mbar	37L/min 2-4mbar	C920Z 
		Rotary vane oil pump can reach extremely high vacuum, but it needs to be used with cold trap	180L/min 4×10^{-4} mbar	R-8D 
Freeze dryer		Rotary vane oil pump is usually used, equipped with oil mist filter and cold trap	180L/min 4×10^{-4} mbar	R-8D 

Application	Picture	Description	Pump speed / Vacuum	Recommended vacuum pump	
Rotary evaporator		0.5~3L evaporating flask, which requires high corrosion resistance of the vacuum pump, and usually needs to be used with a vacuum controller	25L/min 13mbar	C410	
		6~20L evaporating flask, which requires high corrosion resistance of the vacuum pump, and usually needs to be used with a vacuum controller	60L/min 2mbar	C960T	
		50~100L evaporating flask has high requirements for the corrosion resistance of the vacuum pump, and usually needs to be used with a vacuum controller	145L/min 8mbar	C2000T	
Multi-channel vacuum applications		Rotary vane oil pump can provide a large enough pumping rate, but it needs a matching cold trap	360L/min 4×10^{-4} mbar	R-24D	
Biochemical liquid suction pump		After biochemical culture, it is used to separate tissues from culture fluid	25~40L/min 100mbar	BioVac series	
Vacuum controller		Able to set and control the Vacuum control range: vacuum degree of the system 0.1~1000mbar		DVR series	
Digital vacuum gauge		Able to display the vacuum degree of the system in real time	Vacuum measurement range: 0.1~1000mbar	VDM series	



New Entry Level for
Anti-Corrosion Diaphragm Pump



A410

A510

Chemical Resistant Diaphragm Pump (A Series)

- > Chemvak A series are chemical resistant diaphragm vacuum pumps which can be used in the chemical, pharmaceutical, petrochemical and other industries, such as suction filtration, vacuum distillation, rotational evaporation, vacuum concentration, centrifugal concentration, solid phase extraction and so on.
- > A series pumps can be widely used for hard acidic, basic and solvent vapors by utilizing corrosion proof PTFE on all the wetted surfaces. The vacuum chamber and the drive chamber are separated and sealed, ensuring a longer working life of mechanical components
- > Chemvak A series pumps are driven by diaphragm, without the need of lubricant, regular oil changes and maintenance; with no oil pollution.
- > Driven direct by motor with no additional belt-driven transmission; the quality vibration-proof assembly makes Chemvak A series run at the lowest noise level among all other equivalent pumps.
- > Cost-effective, reliable, unique structural design, noise less than 50dB.
- > A variety of models are available to meet the various needs of the laboratory, with a minimum vacuum of up to 8 mbar.
- > Every motor of Chemvak A series pumps has a built-in thermal protection device to shut off the pump automatically when overheated and then resume working when the temperature cools down.

Features

- > No pollution when working
- > Can be used for suction of high temperature steam or condensate
- > Overheat protection and power insurance
- > Chemical resistant design
- > Suitable for corrosive gases and steam media
- > Environmentally friendly design
- > Strong tightness

Model / Specifications	A410	A510
Order No.	170410	170510
Flow rate [m ³ /h] at atm. pressure	1.5	2.4
Flow rate [l/min] at atm. pressure	25	40
Ultimate vacuum [mbar abs.]	13	8
Max. Power P [W]	95	245
Max. current [A]	0.6	1
Motor speed [rpm]	1450	1450
Pump head	Double stage	Double stage
Hose connections [mm]	10	10
Noise [dB]	50	60
Dimensions W x H x D [mm]	230×155×173	290×190×210
Weight [kg]	4.5	10
Power supply	220V/50Hz	220V/50Hz

Chemical Resistant Diaphragm Pumps Flow curve

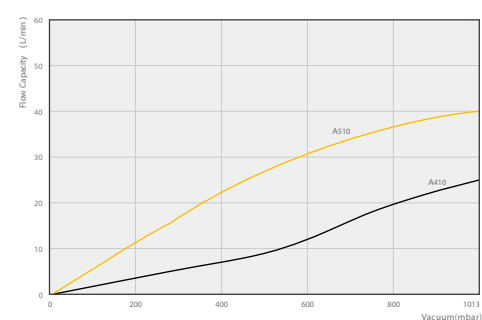

Note: Above data is based on the 220V/50Hz instrument



Chemical Resistant Diaphragm Pump (C Series)

C series construction with PTFE makes them very resistant to chemical vapors from inlet to exhaust and very tolerant to condensates. Pumping chambers are hermetical ensuring long lifetimes of mechanical parts.

Most importantly, diaphragm pumps are oil-free, with vastly reduced service demands compared with oil sealed pumps. They eliminate the cost of water and its contamination well-known from water-jet aspirators, and the waste-oil disposal of rotary vane pumps.

They are chemical resistant diaphragm vacuum pumps which can be widely used for hard acidic, basic and solvent vapors by utilizing corrosion proof PTFE on all the wetted surfaces. Through innovative mechanical technology and human considerations, we have made C series to be quiet, safe, maintenance-free and cost effective vacuum pumps.

Features

High chemical resistant

All wetted parts of C series pump are made of PTFE which is ideal for extremely aggressive / corrosive gases and vapors.

Long-term durable

Head cover and diaphragm made of PTFE/PTFE-coated with stability core for unsurpassed long-term performance

No air pollution, maintenance free

Chemvak C series pumps are driven by diaphragm, without the need of lubricant, regular oil changes and maintenance; with no oil pollution.

Practical

- > smooth surfaces for easy cleaning
- > sealing system provides reduced leakage rates for improved ultimate vacuum

Quiet and low vibration

Driven direct by motor with no additional belt-driven transmission; the quality vibration-proof assembly makes Chemvak C series run at the lowest noise level among all other equivalent pumps.

Thermal protection device

Every motor of Chemvak C series pumps has a built-in thermal protection device to shut off the pump automatically when overheated and then resume working when the temperature cools down.

International safety certification

CE certification

The stability core principle: for unprecedented long-term performance

chemistry diaphragm pumps provide optimum performance and unsurpassed service intervals even in harsh chemical applications. We achieve this unmatched reliability by manufacturing the most highly stressed components – the head cover and clamping disk.

- > high quality PTFE coated EPDM provides long term chemical resistance
- > this thick-walled, diffusion resistant, molded fluoroplastic is supported by a stable metallic core for durability
- > mechanical precision finishing ensures reproducible WIGGENS quality

Application

- > Chemical and petrochemical Industry
- > Pharma Industry
- > Filtration processes
- > Vacuum distillation
- > Rotary evaporation
- > Vacuum and centrifugal concentration
- > Solid phase extraction
- > Conventional drying and gel drying
- > Advanced substitute for water-jet pumps

Chemical Resistant Diaphragm Pumps Flow curve

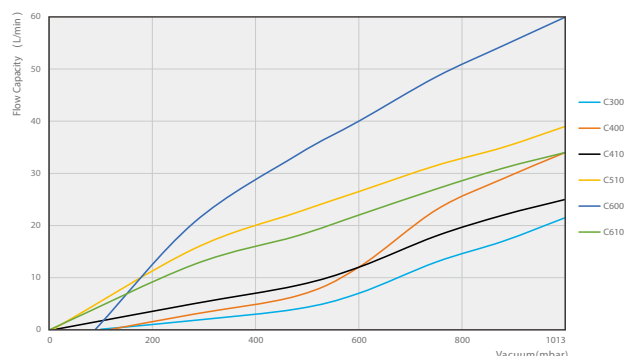

Note: Above data is based on the 220V/50Hz instrument

Packages

Package 1 includes

The pump with vacuum trap, regulator and vacuum gauge (order no. 169311-06)



Package 2 includes

The pump with vacuum trap, regulator and digital meter DVM150C (order no. 169312-06)



Package 3 includes

The pump with chemical resistant vacuum controller DVR480, Vacuum trap



Model / Specifications	C300	C400	C410	C420	C510	C520	C600	C602	C610
Order No.	169300	169400	169410	169420	169510	169520	169600	169602	169610
Flow rate [m ³ /h] at atm. pressure	1.32	2.04	1.5	1.5	2.04	3.0	3.6	4.2	2.22
Flow rate [l/min] at atm. pressure	22	34	25	25	34	50	60	70	37
Ultimate vacuum [mbar abs.]	100	120	13	13	8	8	90	80	2~4
Max. Power P [W]	60	95	95	95	245	245	270	270	270
Max. current [A]	0.5	0.5	0.5	0.5	1.1	1.1	1.1	1.1	1.1
Motor speed [rpm]	1450	1450	1450	1450	1450	1450	1450	1450	1450
Pump head	Single stage	Single stage	Double stage	Double stage	Double stage	Double stage	Single stage	Single stage	Double stage
Hose connections [mm]	10	10	10	10	10	10	10	10	10
Noise [dB]	50	50	50	50	60	55	60	55	60
Dimensions W x H x D [mm]	233×110×210	294×156×195	294×156×195	294×156×195	380×156×226	380×156×226	380×162×226	380×156×226	380×171×226
Weight [kg]	6	8.5	8.5	8.5	13.2	14.5	13.2	14.5	13.8
Power supply	220V/50Hz	220V/50Hz	220V/50Hz	220V/50Hz	220V/50Hz	220V/50Hz	220V/50Hz	220V/50Hz	220V/50Hz

Chemical Resistant Diaphragm Pump

Fast pumping speed

C900 series chemical resistant diaphragm pumps are ideally suited for pumping aggressive gases and vapors in a vacuum range down to 1mbar and pumping speed up to 95L/min

Features

- > All wetted parts are made of chemical resistant materials
- > Fast pumping speed
- > Low noise
- > Overheat protection
- > Vacuum can be controlled by manual valve, vacuum controller
- > Easy and convenient for maintenance



The motor drives the pump head to vacuum

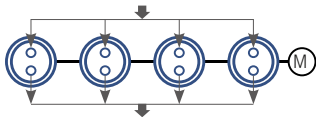

C900E with single stage of pump head

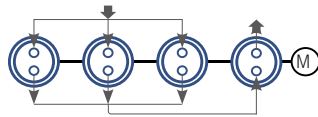

C920Z with double stage of pump head

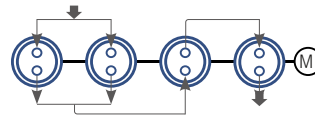

C960T with Triple stage of pump head

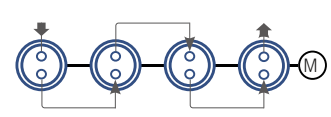

C980V with quadruple stage of pump head

The pump with vacuum trap, regulator and vacuum gauge (order no. 169311-06)



Package 1

The pump with vacuum trap, regulator and digital meter DVM150C (order no. 169312-06)



Package 2

The pump with chemical resistant vacuum controller DVR480, Vacuum trap



Package 3

Model / Specifications	C900E	C920Z	C960T	C980V
Order No.	169900	169920	169960	169980
Flow rate [m ³ /h] at atm. pressure	5.7	4.5	3.6	2.4
Flow rate [l/min] at atm. pressure	95	75	60	40
Ultimate vacuum [mbar abs.]	< 30	< 8	< 2	< 1
Max. Power P [W]	370	370	370	370
Motor speed [rpm]	1425	1425	1425	1425
Pump head	Single stage	Double stage	Triple stage	Quadruple stage
Hose connections [mm]	10	10	10	10
Noise [dB]	50	50	50	50
Dimensions W x H x D [mm]	440×270×240	440×270×240	440×270×240	440×270×240
Weight [kg]	21.5	21.5	21.5	21.5
Power supply	220V/50Hz	220V/50Hz	220V/50Hz	220V/50Hz

Chemical Resistant Diaphragm Pump

Variable-frequency vacuum pump, fast pumping speed

Chemical resistant diaphragm pumps are ideally suited for pumping aggressive gases and vapors in a vacuum range down to 1mbar. and pumping speed up to 95L/min

The variable-frequency pump needs to be connected with the variable-frequency controller to control the vacuum by adjusting the speed of the motor, which is especially suitable for the vacuum control of large-capacity system. It not only ensures a faster pumping speed, but also obtains a stable vacuum.



Variable-frequency vacuum pump W/O frequency controller

Features

- > All wetted parts are made of chemical resistant materials
- > Variable frequency motor for fast pumping speed
- > Low noise
- > Overheat protection
- > Vacuum can be controlled by manual valve, vacuum controller or variable frequency controller
- > Easy and convenient for maintenance



Variable-frequency vacuum pump W/ frequency controller

The motor drives the pump head to vacuum

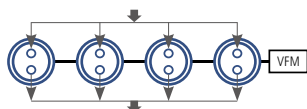

C900EF with variable frequency motor and single stage of pump head

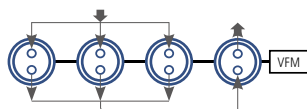

C920ZF with variable frequency motor and double stage of pump head

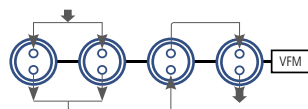

C960TF with variable frequency motor and triple stage of pump head

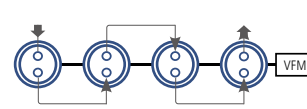

C980VF with variable frequency motor and quadruple stage of pump head

Model / Specifications	C900EF	C920ZF	C960TF	C980VF
Order No. (W/O frequency controller)	169900B	169920B	169960B	169980B
Order No. (W/ frequency controller)	169901B	169921B	169961B	169981B
Flow rate [m ³ /h] at atm. pressure	5.7	4.5	3.6	2.4
Flow rate [l/min] at atm. pressure	95	75	60	40
Ultimate vacuum [mbar abs.]	< 30	< 8	< 2	< 1
Max. Power P [W]	370	370	370	370
Motor speed [rpm]	0~1380/0~1680 ¹⁾	0~1380/0~1680 ¹⁾	0~1380/0~1680 ¹⁾	0~1380/0~1680 ¹⁾
Pump head	Single stage	Double stage	Triple stage	Quadruple stage
Hose connections [mm]	10	10	10	10
Noise [dB]	50	50	50	50
Dimensions W x H x D [mm]	440×270×240	440×270×240	440×270×240	440×270×240
Weight [kg]	21.5	21.5	21.5	21.5
Variable frequency vacuum controller	Order separately	Order separately	Order separately	Order separately
Power supply	200 - 240V, 50/60Hz	200 - 240V, 50/60Hz	200 - 240V, 50/60Hz	200 - 240V, 50/60Hz

¹⁾ means the motor speed range of 50Hz and 60Hz models respectively

Frequency Conversion Chemical Resistant Vacuum Systems

Integrated variable frequency controller

- > A new generation of intelligent vacuum technology, modular design, integrated variable frequency pumps and control units, compact design, light weight. It can adjust the speed of the diaphragm pump by frequency conversion motor and controller, controlling the vacuum pressure more accurately.
- > PID Self-tuning for vacuum control, the controller automatically changes the PID value according to the artificial intelligence logic algorithm, accurately adjusting the motor speed and stabilizing the precise vacuum degree.
- > This series of chemical resistant vacuum pumps are suitable for the treatment of corrosive gases in the chemical, pharmaceutical, petrochemical and other industries, such as extraction, vacuum distillation, rotational evaporation, vacuum concentration, centrifugal concentration, solid phase extraction and other uses.
- > All parts in contact with gas and condensate are made of high-quality PTFE. The gas chamber and drive chamber are separated and sealed to ensure a long life of the mechanical parts
- > Overheat protection, automatic shutdown when the temperature is too high, and automatic start when it goes back to the normal temperature, to ensure the security and stability of the system.

Features

- > Vacuum stability, easy to control, high control precision
- > Excellent chemical and vapour resistance
- > In the high vacuum degree, the performance is still very good.
- > Long life, simple and convenient for maintenance.
- > Simple and convenient to work in a stable and lasting way
- > Small structural size, energy conservation and environmental protection
- > High level of protection for motor, suitable for various environments

Application

- > Vacuum distillation for large volume
- > Large capacity reaction kettle
- > Large capacity vacuum filtration
- > Vacuum enrichment
- > Vacuum drying
- > Various applications in the semiconductor industry



Standard Configuration:

The vacuum system integrated variable frequency controller, and also includes vacuum trap, regulator and vacuum gauge (order no. 169311-06)

Model / Specifications	C900EEF	C920ZEF	C960TEF	C980VEF
Order No.	169900C	169920C	169960C	169980C
Flow rate [m ³ /h] at atm. pressure	5.7	4.5	3.6	2.4
Flow rate [l/min] at atm. pressure	95	75	60	40
Ultimate vacuum [mbar abs.]	< 30	< 8	< 2	< 1
Vacuum setting range [mbar abs.]	0.1~1000	0.1~1000	0.1~1000	0.1~1000
Max. Power P [W]	400	400	400	400
Motor speed [rpm]	0~1380/0~1680 ¹⁾	0~1380/0~1680 ¹⁾	0~1380/0~1680 ¹⁾	0~1380/0~1680 ¹⁾
Pump head	Single stage	Double stage	Triple stage	Quadruple stage
Hose connections [mm]	10	10	10	10
Noise [dB]	50	50	50	50
Dimensions W x H x D [mm]	440×270×240	440×270×240	440×270×240	440×270×240
Weight [kg]	21.5	21.5	21.5	21.5
Power supply	200 - 240V, 50/60Hz	200 - 240V, 50/60Hz	200 - 240V, 50/60Hz	200 - 240V, 50/60Hz

1) means the motor speed range of 50Hz and 60Hz models respectively

Chemical Resistant Diaphragm Pump

Fast pumping speed for industrial applications

C1200 series chemical resistant diaphragm pumps are ideally suited for pumping aggressive gases and vapors in a vacuum range down to 1mbar and pumping speed up to 120L/min.

Features

- > All wetted parts are made of chemical resistant materials
- > Fast pumping speed
- > Low noise
- > Overheat protection
- > Vacuum can be controlled by manual valve, vacuum controller
- > Easy and convenient for maintenance



The motor drives the pump head to vacuum

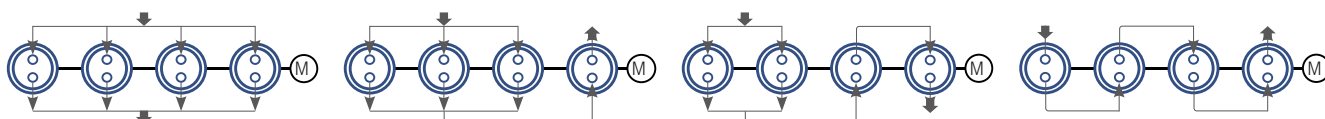

C1200E with single stage of pump head

C1200Z with double stage of pump head

C1200T with triple stage of pump head

C1200V with quadruple stage of pump head

Model / Specifications	C1200E	C1200Z	C1200T	C1200V
Order No.	W1031201	W1031202	W1031203	W1031204
Flow rate [m ³ /h] at atm. pressure	7.2	5.7	4.2	3
Flow rate [l/min] at atm. pressure	120	95	70	50
Ultimate vacuum [mbar abs.]	< 80	< 8	< 2	< 1
Max. Power P [W]	370	370	370	370
Max. current [A]	2	2	2	2
Motor speed [rpm]	1380	1380	1380	1380
Pump head	Single stage	Double stage	Triple stage	Quadruple stage
Hose connections of inlet	KF25 ¹⁾	KF25 ¹⁾	KF25 ¹⁾	KF25 ¹⁾
Hose connections of outlet	G1/2 ¹⁾	G1/2 ¹⁾	G1/2 ¹⁾	G1/2 ¹⁾
Noise [dB]	50	50	50	50
Dimensions W x H x D [mm]	440×270×240	440×270×240	440×270×240	440×270×240
Weight [kg]	21.5	21.5	21.5	21.5
Power supply	220~240V/50Hz	220~240V/50Hz	220~240V/50Hz	220~240V/50Hz

1) Included with Vacuum pump: 2 barbed fittings for tubing 16 mm inner dia.

Chemical Resistant Diaphragm Pump

Fast pumping speed for industrial applications

C2000 series chemical resistant diaphragm pumps are ideally suited for pumping aggressive gases and vapors in a vacuum range down to 1mbar and pumping speed up to 245L/min.

Features

- > All wetted parts are made of chemical resistant materials
- > Fast pumping speed
- > Low noise
- > Overheat protection
- > Vacuum can be controlled by manual valve, vacuum controller
- > Easy and convenient for maintenance



The motor drives the pump head to vacuum

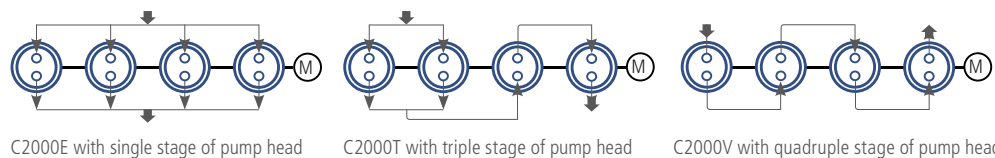

Model / Specifications	C2000E	C2000T	C2000V
Order No.	W1032001	W1032002	W1032003
Flow rate [m ³ /h] at atm. pressure	14.7	10.8	9.0
Flow rate [l/min] at atm. pressure	245	180	150
Ultimate vacuum [mbar abs.]	< 70	< 2	< 1
Max. Power P [W]	750	750	750
Motor speed [rpm]	1380	1380	1380
Pump head	Single stage	Triple stage	Quadruple stage
Hose connections of inlet	KF25 ¹⁾	KF25 ¹⁾	KF25 ¹⁾
Hose connections of outlet	G1/2 ¹⁾	G1/2 ¹⁾	G1/2 ¹⁾
Noise [dB]	60	60	60
Dimensions W x H x D [mm]	615×285×386	615×285×386	615×285×386
Weight [kg]	41	41	41
Power supply	220~240V/50Hz	220~240V/50Hz	220~240V/50Hz

Chemical Resistant Diaphragm Pump

Variable-frequency vacuum pump, fast pumping speed

Chemical resistant diaphragm pumps are ideally suited for pumping aggressive gases and vapors in a vacuum range down to 1mbar.

Features

- > All wetted parts are made of chemical resistant materials
- > Variable frequency motor for fast pumping speed
- > Low noise
- > Overheat protection
- > Vacuum can be controlled by manual valve, vacuum controller or variable frequency controller
- > Easy and convenient for maintenance



The motor drives the pump head to vacuum

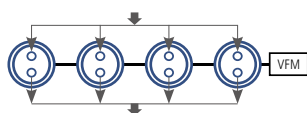

C2000EEF with variable frequency motor and single stage of pump head

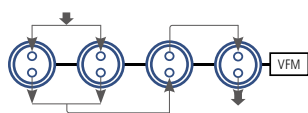

C1450TEF / C2000TEF with variable frequency motor and triple stage of pump head

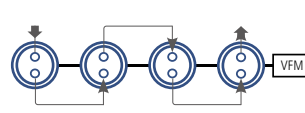

C2000VEF with variable frequency motor and quadruple stage of pump head

The variable-frequency pump needs to be connected with the variable-frequency controller to control the vacuum by adjusting the speed of the motor, which is especially suitable for the vacuum control of large-capacity system. not only ensures a faster pumping speed, but also obtains a stable vacuum.



C1450TEF

Model / Specifications	C2000EEF	C2000TEF	C2000VEF	C1450TEF
Order No.	W1032011	W1032012	W1032013	1691450C
Flow rate [m ³ /h] at atm. pressure	14.4	10.2	7.8	
Flow rate [l/min] at atm. pressure	270	210	160	145
Ultimate vacuum [mbar abs.]	< 70	< 2	< 1	< 8
Max. Power P [W]	750	750	750	600
Motor speed [rpm]	0~1380	0~1380	0~1380	0~1400
Pump head	Single stage	Triple stage	Quadruple stage	Triple stage
Hose connections of inlet	KF25 ¹⁾	KF25 ¹⁾	KF25 ¹⁾	10mm
Hose connections of outlet	G1/2 ¹⁾	G1/2 ¹⁾	G1/2 ¹⁾	G1/2
Noise [dB]	60	60	60	65
Dimensions W x H x D [mm]	615×285×386	615×285×386	615×285×386	635×280×200
Weight [kg]	41	41	41	36.5
Power supply	200 - 240V, 50/60Hz	200 - 240V, 50/60Hz	200 - 240V, 50/60Hz	200 - 240V, 50/60Hz

Vacuum Solvent Recovery System

This chemistry vacuum system has a wide range of applications like evacuation, evaporation and pumping of gases and vapors in chemical, biological and pharmaceutical laboratories. This system is ideal for high vacuum requirements with high boiling solvents. Typical applications are rotary evaporators and drying ovens.

The separator at the inlet, made of glass with a protective coating, retains particles and liquid droplets.

The waste vapor condenser at the outlet is highly efficient and compact. The condenser enables efficient recycling of solvents and active protection of the environment outstanding chemical resistance and superior vapor tolerance

- > exceptionally high performance even at low vacuum
- > excellent ultimate vacuum even with gas ballast
- > whisper quiet and very low vibration
- > excellent environmental friendliness due to efficient solvent recovery

- > Sealed system to enable a good distillation environment
- > Precise control of the evaporation process
- > Compact and environmental friendly design
- > Low noise

- > Buffer bottle prevents particles from damaging the pump
- > Direct electric connection
- > Ultimate vacuum range: 1-30 mbar
- > Flow rate range: 25-95 L/min

CSH System

The inlet of the CSH System is connected to a segregation bottle, whereas the outlet is connected to a condenser, which is used to condensate and recover the solvent.

Model	CSH410	CSH510	CSH520	CSH610
Build in Pump Type	C410	C510	C520	C610
Power (W)	95	245	150	245
Ultimate Vacuum (mbar)	13	8	8	2
Max. Flow Rate (l/min)	25	34	50	34
Outlet Size (outer diameter in mm)	10	10	10	10
Weight (kg)	12.5	15.8	15.8	16.6
Order No.	900512	900513	900515	900514



CSH System
Includes chemical resistant diaphragm pump, separator, condenser, tubing

CSC System

The inlet of the CSC System is connected to a segregation flask, whereas the outlet is connected to a condenser, which is used to condensate and recover the solvent. In addition, the system contains a vacuum controller to set, display, and control the vacuum.

Fully automated vacuum generation system comprising chemical resistant diaphragm vacuum pump, base plate, high performance condenser, segregation flask, vacuum control device and valves.

Model	CSC410	CSC510	CSC520	CSC610
Build in Pump Type	C410	C510	C520	C610
Power (W)	95	245	150	245
Ultimate Vacuum (mbar)	13	8	8	2
Max. Flow Rate (l/min)	25	34	50	34
Outlet Size (outer diameter in mm)	10	10	10	10
Weight (kg)	16	19.3	19.3	20.1
Order No.	900522	900523	900525	900524



CSC System
Includes chemical resistant diaphragm pump, vacuum controller, separator, condenser, tubing

CSC Systems (Frequency conversion model)

- > New generation of intelligent vacuum technology, modular design, integrated variable frequency pumps and control units, compact design, light weight.
- > PID Self-tuning for vacuum control, the controller automatically changes the PID value according to the artificial intelligence logic algorithm, accurately adjusting the motor speed to get the precise vacuum value.
- > All parts in contact with gas and condensate are made of high-quality PTFE. The gas chamber and drive chamber are separated and sealed to ensure a long life of the mechanical parts
- > It can be directly connected to the power supply and working system.
- > Recovery flasks at air inlet to prevent solid particles and liquid water from entering the pump chamber.

Model	CSC900E	CSC920Z	CSC960T	CSC980V
Power (W)	400	400	400	400
Resolution	0.1mbar	0.1mbar	0.1mbar	0.1mbar
Setting range	0.1-1000mbar	0.1-1000mbar	0.1-1000mbar	0.1-1000mbar
Max. vacuum (mbar)	< 30	< 8	< 2	< 1
Max. Flow Rate (L/min)	95	75	60	40
Outlet (mm)	10	10	10	10
Weight (kg)	25	25	25	25
Noise Level (dB)	50	50	50	50
Order No.	900532	900533	900534	900535



CSC System (Frequency conversion)
Includes chemical resistant diaphragm pump, variable frequency controller, separator, condenser, tubing

Chemical Resistant Vacuum Controller

- > Wide measurement and control range
- > Control the vacuum down to 0.1 mbar
- > Up to 5-step program control
- > All parts that come into contact with gases and vapors are made of PTFE or highly durable ceramic to ensure high chemical resistance
- > Bright LED display and convenient on-touch control
- > RS-232 and analog connection available
- > Pressure release feature for easy vacuum system installation
- > Direct electric control of the vacuum pump
- > Energy saving and environmental friendly
- > Suitable for continuous operation

Specifications

Model	DVR480	DVR480-Pro
Order No.	900414-1	900414-2
Voltage	100-240V, 50/60Hz	100-240V, 50/60Hz
Displayed Vacuum Accuracy	0.1 mbar	0.1 mbar
Controllable Range	0.1...1000 mbar	0.1...1000 mbar
Measurement Accuracy	0.25%FS	0.1%FS
Display	LED	LED
Control Mode	On-Touch	On-Touch
Timer / Program	Yes / Up to 5 Steps	Yes / Up to 5 Steps
Pressure Release Feature	Yes	Yes
Electrical Control of the Pump	Yes	Yes
Protection Category	IP40	IP40
Corrosion resistance	All parts that come into contact with gases are made of PTFE or highly durable ceramic to ensure the resistance to various acid, base, or organic solvent gases.	



DVR480

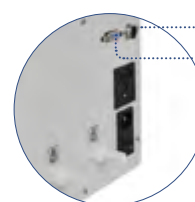

..... Analog Signal Input and Output Port
..... RS-232 / RS-485, Modbus

Accessories For Chemical Resistant Diaphragm Pumps

General Purpose Valves

A range of plug valves for applications with demand for pressure and temperature, with max. pressure at 1 bar and max. vacuum at 7mbar.

Note: Rapid changes in temperature in excess of 25°C /min may cause these valves to leak due to the expansion properties of PTFE. It can be sterilised at 135°C .

Order No.	Outer Diameter/mm	Bore (mm)	Order No.	Outer Diameter/mm	Bore (mm)
	mm	mm		mm	mm
Straight Through Bayonet			Straight Through Connector		
016.702.5.2	4.5	2	016.902.5.2	4.5	2
016.702.2	6.0	2	016.902.2	6.0	2
016.703.7.2	6.8	3	016.903.7.2	6.8	3
016.703.2	8.0	3	016.903.2	8.0	3
016.704.9.2	9.0	4	016.904.9.2	9.0	4
016.704.2	10.0	4	016.904.2	10.0	4
016.705.2	11.0	5	016.905.2	11.0	5
Straight Through Screw			L-Shape Connector		
016.1202.6.2	6	2	016.1002.5.2	4.5	2
016.1203.2	8	3	016.1002.2	6.0	2
016.1204.2	8	4	016.1003.7.2	6.8	3
			016.1003.2	8.0	3
			016.1004.9.2	9.0	4
			016.1004.2	10.0	4
			016.1005.2	11.0	5
T-Shape Bayonet			T-Shape Connector		
016.802.5.2	4.5	2	016.1102.5.2	4.5	2
016.802.2	6.0	2	016.1102.2	6.0	2
016.803.7.2	6.8	3	016.1103.7.2	6.8	3
016.803.2	8.0	3	016.1103.2	8.0	3
016.804.9.2	9.0	4	016.1104.9.2	9.0	4
016.804.2	10.0	4	016.1104.2	10.0	4
016.805.2	11.0	5	016.1105.2	11.0	5
T-Shape Screw			4-Way Connector		
016.1302.6.2	6	2	016.1112.5.2	4.5	2
016.1303.2	8	3	016.1112.2	6.0	2
016.1304.2	8	4	016.1113.7.2	6.8	3
			016.1113.2	8.0	3
			016.1114.9.2	9.0	4
			016.1114.2	10.0	4
			016.1115.2	11.0	5



Straight Through Connector



L-Shape Connector



Straight Through Bayonet



T-Shape Connector



Straight Through Screw



4-Way Connector



T-Shape Bayonet



T-Shape Screw

Accessories For Chemical Resistant Diaphragm Pumps

PTFE Connector

Order No.	Description
C410015	Diameter: 10mm, suitable for C300, 400, 410, 510, 600, 610, 900E, 920Z and 960T



PTFE Connector with O-ring

Adapter (Flange to screw thread)

Order No.	Description
C410055	KF25 to screw thread, suitable for C300, 400, 410, 510, 600, 610, 900E, 920Z and 960T



Adapter (Flange to screw thread)

Silencer

Order No.	Description
C900E030	suitable for chemical resistant diaphragm pumps



Silencer

Diaphragm and Valve Plate Sets

Order No.	Description
410001	Diaphragm and Valve Plate Set, 1 diaphragm and 2 valve plate, suitable for C300/400/410
510001	Diaphragm and Valve Plate Set, 1 diaphragm and 2 valve plate, suitable for C510/600/610/900E/920Z/960T/980V
C410005	Diaphragm, suitable for C300/400/410, 1/pk
C510011	Diaphragm, suitable for C510/600/610/900E/920Z/960T/980V, 1/pk
C510013	Valve Plate, suitable for C300/400/410/C510/600/610/900E/920Z/960T/980V, 1/pk



Diaphragm



Valve Plate

Tubing

Order No.	Outer Diameter, mm	Inner Diameter, mm	Thickness, mm	Length, m
PTFE Tubing				
016.1706.01	6	4	1	1
016.1708.01	8	6	1	1
016.1712.01	12	10	1	1
016.1714.01	14	12	1	1
Viton Tubing				
168000-01	12	6	3	1
168001-01	14	8	3	1
168002-01	16	10	3	1

Length upon request (min. 1 m)



PTFE Tubing



Viton Tubing

Chemical Resistant Vacuum Regulator / Filter Equipment

Order No.	Description
169311-06	Set 1 (Includes vacuum trap, regulator and vacuum gauge)
169312-06	Set 2 (Includes vacuum trap, regulator and digital meter DVM150C)
169313-06	Regulator

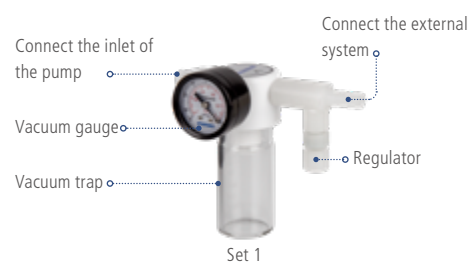

Set 1



Set 2

Part	Material	Part	Material
Pressure Regulating Valve	PVDF	Filter Bottle	Borosilicate Glass
Filter cartridge	PTFE	Adapter	PTFE
Filter Bracket	ABS	Vacuum Sensor	Stainless Steel

Digital Vacuum Meter

- > Designed for chemical resistant diaphragm pumps
- > Compact design, flange connector, strong tightness
- > TFT high brightness screen, easy for observation from multiple angles or long distance
- > Can be directly connected to vacuum pump by flange connection

Models	DVM150C
Voltage	100-240V, 50/60Hz
Display screen	High brightness TFT
Display resolution	0.1-1000mbar
Testing range	0-1000mbar
Material of sensor	Ceramic
Material for contact parts of the gas	PTFE and Ceramic
Size of the meter	100*65*55mm
Order No.	15060-01



Application Guide

For rotary evaporator



Pump models	Max. vacuum (mbar)	Flow Rate (L/min)	Suitable for
C410	13 mbar	25 L/min	1L / 2.5L
C510	8 mbar	34 L/min	5L
C600	90 mbar	60 L/min	10L
C610	2 mbar	34 L/min	5L
C920Z	8 mbar	75 L/min	50L,100L

For vacuum oven



Pump models	Max. vacuum (mbar)	Flow Rate (L/min)	Suitable for
C410	13 mbar	25 L/min	15L
C510	8 mbar	34 L/min	45L
C600	90 mbar	60 L/min	60L
C610	2 mbar	34 L/min	30L

For vacuum concentrator



Pump models	Max. vacuum (mbar)	Flow Rate (L/min)
C410	13mbar	25L/min
C510	8 mbar	34 L/min
C600	90 mbar	60 L/min
C610	2 mbar	34 L/min

For vacuum freeze dryer



Pump models	Max. vacuum (mbar)	Flow Rate (L/min)
R-8D	4x10 ⁻⁴ mbar	180 L/min
R-17D	4x10 ⁻⁴ mbar	283 L/min
R-24D	4x10 ⁻⁴ mbar	360 L/min
R-36D	4x10 ⁻⁴ mbar	540L/min

Oil-Free Piston Vacuum Pump

Chemvak V series vacuum pump is a piston-powered, oil-free pump. With innovative electronic, mechanical technology and human design concept, compact and light weight, clean and maintenance free, safe and comfortable.

Features

No air pollution, maintenance free

Chemvak V series pumps are driven by piston, without the need of lubricant, regular oil changes and maintenance; with no oil pollution.

Moisture trap with filter cartridge

Chemvak V series pumps are equipped with filter cartridge in air inlet to filter particle and moisture to prolong the life of pump.

Oil-free

The oil-free piston vacuum pump provides continuous, reliable, high flow vacuum for your container.

Vacuum regulator

Chemvak V series pumps are equipped with vacuum regulator to adjust vacuum.

Thermal protection device

Every motor of Chemvak V series pumps has a built-in thermal protection device to shut off the pump automatically when overheated and then resume working when the temperature cools down.

Application

- > Biology laboratories
- > Food industry
- > Microbiological detection
- > Vacuum extraction
- > Liquid filtration
- > Vacuum drying
- > Suspended solids measurement

Oil-Free Piston Vacuum Pumps flow curve

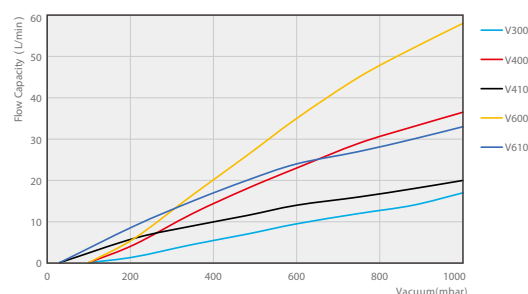

Note: Above data is based on the 220V/50Hz instrument



Model / Specifications	V300DC	V300	V400	V410	V430	V600	V610	V800	V810
Order No.	167330	167300	167400	167410	167430	167600	167610	167800	167810
Flow rate [m ³ /h] at atm. pressure	1.02	1.02	2.04	1.14	1.68	3.6	2.4	4.8	3
Flow rate [l/min] at atm. pressure	17	17	34	19	28	60	40	80	50
Ultimate vacuum [mbar abs.]	150	100	100	30	150/5.5	120	30	100	30
Max. Power P [W]	35	60	80	80	125	190	210	220	220
Max. current [A]	3	0.3	0.4	0.4	0.6	1	1	1	1
Motor speed [rpm]	1450	1450	1450	1450	1450	1450	1450	1450	1450
Hose connections [mm]	9	9	9	9	9	9	9	9	9
Noise [dB]	50	50	60	50	50	52	52	52	52
Dimensions W x H x D [mm]	272x142x165	272x142x165	310x152x165	310x152x165	247x235x200	350x170x195	350x170x195	350x170x195	350x170x195
Weight [kg]	4.4	4.4	5.4	5.4	5.5	8.6	8.6	8.6	8.6
Power supply	DC12	220V/50Hz	220V/50Hz	220V/50Hz	220V/50Hz	220V/50Hz	220V/50Hz	220V/50Hz	220V/50Hz

Accessories For Oil-Free Piston Pumps

Connectors



Description	Suitable for	Order No.
Connectors		
Outlet Diameter 9.5 mm	Oil-Free Piston Pumps	167300-20
Outlet Diameter 8 mm	Oil-Free Piston Pumps	167300-21
Outlet Diameter 6.4 mm	Oil-Free Piston Pumps	167300-26
Outlet Diameter 4.8 mm	Oil-Free Piston Pumps	167300-23
Outlet Diameter 3.2 mm	Oil-Free Piston Pumps	167300-24

L-Shape Connector

Outlet Diameter 8 mm	Oil-Free Piston Pumps	167300-25
----------------------	-----------------------	-----------

Quick Connection Outlets

Outlet Diameter 12 mm	Oil-Free Piston Pumps	168100-12
Outlet Diameter 10 mm	Oil-Free Piston Pumps	168100-10
Outlet Diameter 8 mm	Oil-Free Piston Pumps	168100-08
Outlet Diameter 6 mm	Oil-Free Piston Pumps	168100-06
Outlet Diameter 4 mm	Oil-Free Piston Pumps	168100-04

Silencer

Description	Suitable for	Order No.
Silencer	V300/400/410/V430	167300-42
Silencer	V600/610/V800/V810	167600-42

Tubing

Outer Diameter mm	Inner Diameter mm	Thickness mm	Length m	Suitable for	Order No.
PER Tubes					
6	4	1	1	A,C,V Pumps	168010-01
8	6	1	1	A,C,V Pumps	168011-01
10	8	1	1	A,C,V Pumps	168012-01
12	10	1	1	A,C,V Pumps	168013-01
Silicon Tubes					
12	6	3	1	V Pumps	168020-01
14	8	3	1	V Pumps	168021-01
16	10	3	1	V Pumps	168022-01

Length upon request (min. 1m)

Foot Pedal

Description	Suitable for	Order No.
Foot Pedal	Applicable to C and V Series Vacuum Pumps	167200-41

Non-Chemical-Resistant Filtration Device

Description	Order No.
Non-Chemical-Resistant Filtration Device Set 1(incl. pressure gauge)	167300-05

Rotary Vane Vacuum Pump

Oil-sealed Rotary Vane vacuum pumps are widely used traditional vacuum pumps in research and production, which can be used independently, or serve as backing pumps for molecular pumps or diffusion pumps. Wiggins' direct driven rotary vane pumps are available as one and two-stage versions, covering the range from desktop lab pumps to production line pumps, with low noise and stable working temperature for common voltages and frequencies, long lifespan, and outstanding reliability for chemical applications. Various application areas may include vacuum distillation, vacuum filtration, vacuum inspection, vacuum freeze drying, vacuum coating, vacuum leak detection, vacuum packaging, vacuum adsorption, etc.



R-4SN



R-8SN



R-16SN



Oil level indication



Connector and adapter



Pumping rate curve

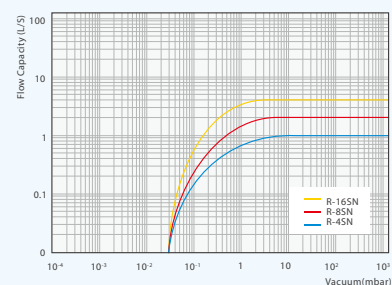

Note: Above data is based on the 220V/50Hz instrument

Model / Specifications	R-4SN	R-8SN	R-16SN
Order No.	900101	900102	900104
Flow rate [m ³ /h] at atm. pressure	3	7.2	14.4
Flow rate [l/min] at atm. pressure	50	120	240
Ultimate vacuum [mbar abs.]	2.5 x10 ⁻²	2.5 x10 ⁻²	2.5 x10 ⁻²
Max. Power P [W]	180	250	550
Motor speed [rpm]	1400	1400	1400
Hose connections of inlet	SAE 3/8" / UNF 7/16-20	SAE 3/8" / UNF 7/16-20	DN25KF
Hose connections of outlet	DN25KF	DN25KF	DN25KF
Oil filling volume [L]	0.25	0.33	1
IP code	IP40	IP40	IP40
Noise [dB]	54	54	54
Dimensions W x H x D [mm]	314×280×122	314×288×142	512×300×158
Weight [kg]	9	11	22
Power supply	220V/50Hz	220V/50Hz	220V/50Hz



Features

- > Compact structure
- > Very good sealing
- > No returning throughput
- > Oil-spout prevention
- > Low noise
- > Oil-observation window
- > Handle for easy transportation
- > High flow rate
- > Low and stable ultimate vacuum
- > High evaporation resistance
- > Comparatively high chemical resistance
- > High longevity
- > Low maintenance rate
- > Low oil mist
- > Gas ballast valve
- > Overcurrent protection

Application

- > Vacuum distillation
- > Vacuum filtration
- > Vacuum testing
- > Vacuum freeze drying
- > Vacuum plating
- > Leak detection
- > Vacuum packaging
- > Vacuum sorption
- > As a backing pump for turbo-molecular pumps or diffusion pumps

Pumping rate curve

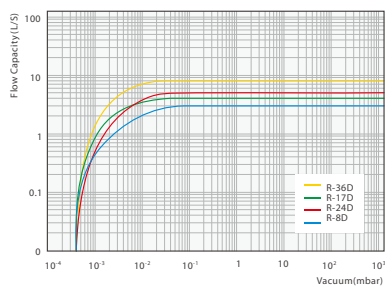

Note: Above data is based on the 220V/50Hz instrument

Model / Specifications	R-8D	R-17D	R-24D	R-36D
Order No.	900111	900112	900025	900035
Flow rate [m ³ /h] at atm. pressure	10.8	16.8	21.6	32.4
Flow rate [l/min] at atm. pressure	180	280	360	540
Ultimate vacuum [mbar abs.]	4.0 x10 ⁻⁴	4.0 x10 ⁻⁴	4.0 x10 ⁻⁴	4.0 x10 ⁻⁴
Max. Power P [W]	550	750	750	1100
Motor speed [rpm]	1400	1400	1400	1400
Hose connections of inlet	DN25KF	DN25KF	DN25KF	DN25KF
Hose connections of outlet	DN25KF	DN25KF	DN25KF	DN25KF
Oil filling volume [L]	1.1	1.4	1.9	2.1
IP code	IP44	IP44	IP44	IP44
Noise [dB]	54	54	56	56
Dimensions W x H x D [mm]	485 x 252 x 165	510 x 252 x 165	570 x 288 x 205	600 x 288 x 205
Weight [kg]	29	31	37	39
Power supply	220V/50Hz	220V/50Hz	220V/50Hz	220V/50Hz

Accessories for Rotary Vane Vacuum Pumps



900111-1 900101-1



Dust Filter



Flange adapter

Adapter

Oil Mist Filter, Condensate Separator, Dust Filter

The gas pumping out from the outlet often has some oil mist, which will effect the ambient, and sometimes is harmful. Chemvak's exhaust filter can almost stop all the oil mist and let it flow back to the pump and can reduce noise as well.

Name	Suitable for	Order No.
Oil mist trap	R-4SN, R-8SN (Direct connection, outlet DN25KF)	900101-1
Oil mist trap	R-16SN, R-8D, R-17D, R-24D, R-36D (Direct connection, outlet DN25KF)	900111-1
Filter element for oil mist trap	Replacement for 900111-1 oil mist trap	900111-2
Condensate separator	R-16SN, R-8D, R-17D, R-24D, R-36D	900111-3
Dust filter	R-16SN, R-8D, R-17D, R-24D, R-36D	900111-4

Adppter

Name	Description	Order No.
Adppter	Specification: 3/8 SAE; Outlet Diameter: 8mm; R-4SN / R-8SN	168900-82
Adppter	Specification: 3/8 SAE; Outlet Diameter: 10mm; R-4SN / R-8SN	168900-83
Adppter	Specification: 3/8 SAE; Outlet Diameter: 12mm; R-4SN / R-8SN	168900-84
Flange adppter	Inlet: DN25KF; Outlet Diameter: 8mm; Suitable for R-16SN, R-8D, R-17D, R-24D, R-36D	168900-08
Flange adppter	Inlet: DN25KF; Outlet Diameter: 10mm; Suitable for R-16SN, R-8D, R-17D, R-24D, R-36D	168900-10
Flange adppter	Inlet: DN25KF; Outlet Diameter: 12mm; Suitable for R-16SN, R-8D, R-17D, R-24D, R-36D	168900-12
Flange adppter	Inlet: DN25KF; Outlet Diameter: 19mm; Suitable for R-16SN, R-8D, R-17D, R-24D, R-36D	168900-19
Flange adppter	Inlet: DN25KF; Outlet Diameter: 25mm; Suitable for R-16SN, R-8D, R-17D, R-24D, R-36D	168900-25



Digital Vacuum Meter

- > Designed for rotary vane pumps
- > Compact design, flange connector, strong tightness
- > TFT high brightness screen, easy for observation from multiple angles or long distance
- > Can be directly connected to vacuum pump by flange connection, material for contact parts of the gas is stainless steel

Models	Display resolution	Testing range	Material of sensor	Size of the meter	Order No.
DVM150Pro	0.001mbar	0.001-9.999mbar	PIRANI	100*65*55mm	15060-02
No.	Description	Order No.			
①	Connector, KF16 to KF25, suitable for R-16SN, R-8D, R-17D, R-24D, R-36D	DVM150BJFL001			
②	Connector, KF16 to threaded connector, suitable for R-4SN, R-8SN	DVM150BJFL002			
③	KF16 flange clamp	BJFL003			
④	KF25 flange clamp	BJFL004			



①

②

④③

Highspeed Pump Oil

ChemVak highspeed oil employs a very good lubricant function, and has a high emulsion and oxidation resistance. It helps maintain the longevity of the system and reach a stable ultimate vacuum.

Specifications	Order No.
500 mL	900100-04
1 L	900100-05
5 L	900100-02
10 L	900100-03



Thick Vacuum Tubing

Thick rubber tube, which can be used for very high-vacuum applications

Inner Diameter(mm)	Thickness (mm)	Length(m)	Order No.
8	5	1	22690-06
10	9.5	1	22690-11
12	9.5	1	22690-13
19	9.5	1	22690-21
25	9.5	1	22690-26



Krytox LVP High-Vacuum Grease

Very stable, incombustible silicon grease, which is suitable for high-vacuum systems. In high-vacuum environments or high personal risk environments it can be used as a lubricant or sealing compound for plugs, valves, and connecting pieces. It can be used in laboratory or pilot equipment

Specifications	Order No.
2 oz.	8116-10

Electrical Aspirator Pump

Portable dual-channel, water-jet aspirator pump.

VE-11 creates a vacuum using an aspirator pump that is dependent on the vapor pressure of water. Ideal for rotary vacuum evaporators, decompressing distillatories, vacuum dryers, and vacuum filtering units.

Features

- > Economic use of resources
- > High flow rate up to 36 L/min
- > Vacuum can be regulated between 20 mmHg and 74 mmHg
- > Employs two water flow and gas suction devices, a check valve, and an upstream prevention device
- > Housing is made of PP to enhance longevity
- > Small amounts of liquid in the machine don't harm the system. Built-in circulating pump and water tank makes this unit portable and eliminates water waste.
- > Circulating pump continuously forces water quietly across a set of aspirators, and therefore clean and efficient.
- > Included (2) metal aspirators to create a vacuum with a built-in check valve to prevent backflow of water into the aspirator pump.
- > Submerged parts: 304 stainless steel, polypropylene silicone, and nickel-coated brass.
- > Tank features a drain port and spigot for easy water changes.
- > Unlike other vacuum pumps the VE-11 can suck a little bit of solvent. (water)



Included Accessories

- > Tank / Aspirating pump / Tank closure.
- > Two aspirators.
- > Two ø6mm (0.02") silicone rubber tube 20cm (0.7 ft) in length and an additional ø6mm (0.02") silicone rubber tube 100cm (3.3 ft) in length.

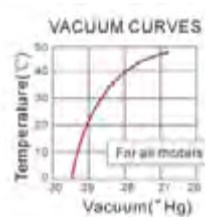

VE-11

with optional vacuum gauge / regulator

Specifications & Ordering Information

Model	VE-11	
Max. Flow Rate	36 L/min (18 L/min*2)	
Water Tank Capacity(L)	9.5 L	
Motor Power(W)	150 W	
Material (Water Tank)	Polypropylene	
Dimensions	Water Tank(WxDxH)	298 x 210 x 227
	Case(WxDxH)	330 x 265 x 390
	Absorption nozzle	9.5 Ø x 2
	Overflow nozzle	17 Ø
Safety Devices	Fuse, check valve, overheat protection	
Weight (kg)	5.7	
Order No.	900701	

Application Area

- > Filtration
- > Distillation
- > Rotary evaporation



Vacuum Gauge / Regulator (Option)

Optional Accessories

- > Vacuum gauge / regulator: to monitor and control the vacuum pressure. (between 0.0267~0.0998MPa / 7.9~29.5" Hg)
- > Cooling coil: to prevent vacuum from decreasing due to temperature increase.

Accessories

Description	Order No.
Vacuum Gauge / Regulator	900701-1
VC-10 Cooling Coil	900701-2
ET-02 Aspirator	900701-3



VC-10 Cooling Coil



ET-02 Aspirator



Vacuum Filtration

Single position vacuum filtration system

Portable vacuum filtration system



Bench-top vacuum filtration system



Vacuum pump and filtration sets



Multi-position vacuum filtration system

Spin-lock type



Quick-insert type



Vacuum pump and filtration sets

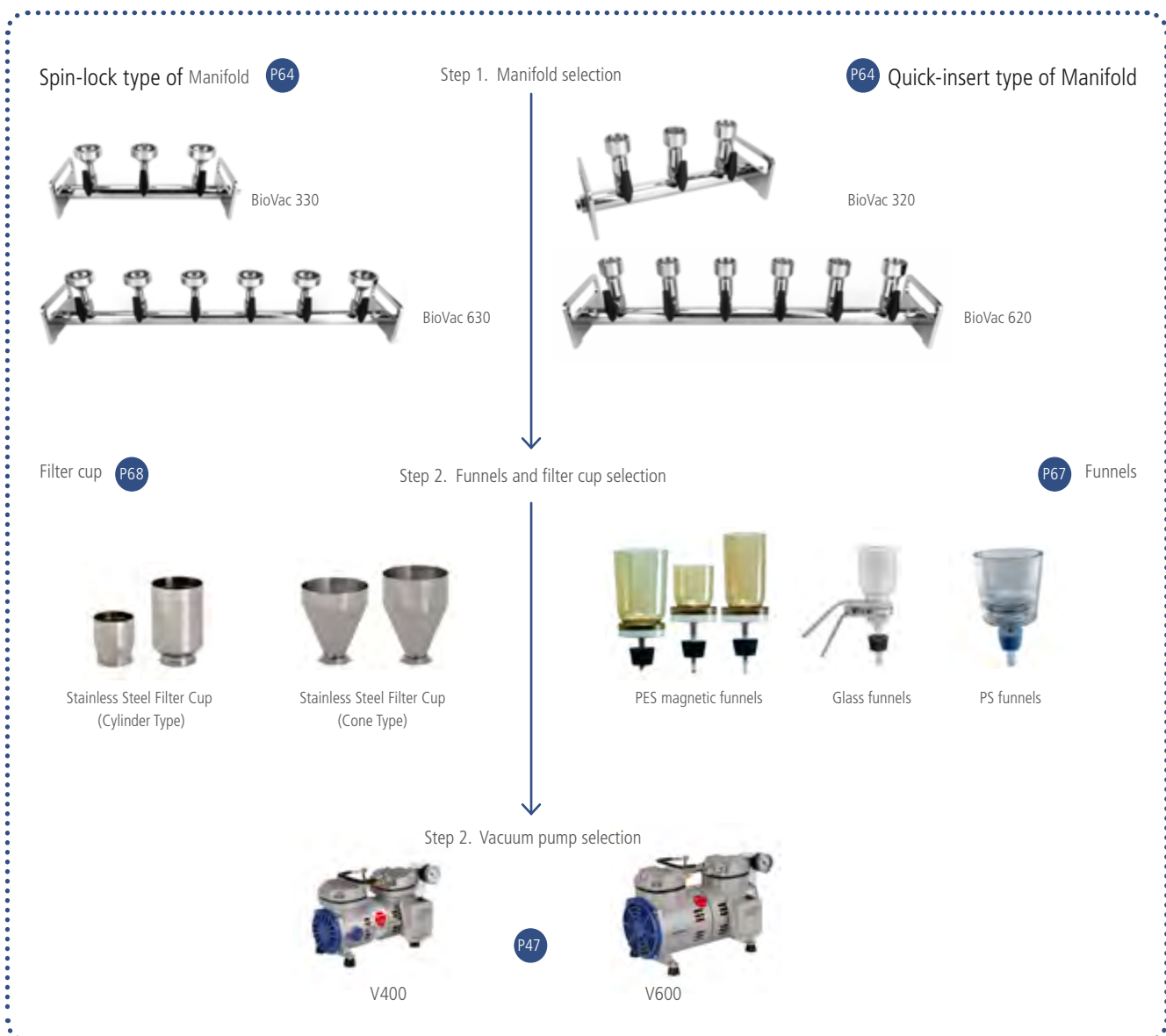

Portable vacuum filtration system

All-In-One Systems

- > Compact and portable design
- > Combines all necessary items for filtration
- > Large varieties of filtration flasks
- > Oil-free vacuum provision
- > Easy maintenance
- > Low noise level
- > Manual pressure control
- > Availability of chemical resistant systems



Product	Content	Application	Contained Filtration Glass Set
VF203A	<ul style="list-style-type: none"> > Oil-free vacuum pump > VF6 filtration flask set > Silicone tube > 0.2 µm water-blocking filter > Fiberglass filter membrane fiberglass filter membrane (47mm / 1 µm) 	Normal filtration Suspended solids measurement	
VF203B	<ul style="list-style-type: none"> > Oil-free vacuum pump > VF2 filtration flask set > Dragon 100 lab burner > Silicone tube > 0.2 µm water-blocking filter > Fiberglass filter membrane fiberglass filter membrane (47mm / 1 µm) 	Normal filtration Microorganism determination	
VF205A	<ul style="list-style-type: none"> > Strong oil-free vacuum pump > VF6 filtration flask set > Silicone tube > 0.2 µm water-blocking filter > Fiberglass filter membrane fiberglass filter membrane (47mm / 1 µm) 	Normal filtration Suspended solids measurement	
VF205B	<ul style="list-style-type: none"> > Strong Oil-free vacuum pump > VF2 filtration flask set > Dragon 100 lab burner > Silicone tube > 0.2 µm water-blocking filter > Fiberglass filter membrane fiberglass filter membrane (47mm / 1 µm) 	Normal filtration Microorganism determination	
VF204	<ul style="list-style-type: none"> > Chemical resistant vacuum pump > VF3 filtration flask set > High-pressure resistant tube > 0.2 µm water-blocking filter 	HPLC Gas chromatography AA micro-analysis Mobile phase decontamination	
VF214	<ul style="list-style-type: none"> > Strong chemical resistant vacuum pump > VF3 filtration flask set > High-pressure resistant tube > 0.2 µm water-blocking filter 	HPLC Gas chromatography AA micro-analysis Mobile phase decontamination	

Specifications

Model	VF 203A	VF 203B	VF 205A	VF 205B	VF 204	VF 214
Working mode	All-In-One Filtration System		All-In-One Filtration System		Chemical Resistant Vacuum Filtration System	
Power (W)	60	60	80	80	60	95
Ultimate vacuum(mbar)	150	150	150	150	100	13
Max. Flow Rate(L/min)	17 L/min	17 L/min	34 L/min	34 L/min	22 L/min	25 L/min
Tube I.D. (mm)	8	8	8	8	8	8
Motor Speed (rpm)	1450	1450	1450	1450	1450	1450
Weight (kg)	7.1	7.1	7.5	7.5	7.1	8.3
Noise Level (dB)	50	50	60	60	50	50
Contained Filtration Glass Set	VF6	VF2	VF6	VF2	VF3	VF3
Order No.	167203A	167203B	167205A	167205B	169204	169214

Bench-top vacuum filtration system

Features

- > Wide range of pumps and filtration flasks
- > High quality components
- > Quick filtration results
- > Easily exchangeable elements

Application

- > Suspended solids measurement
- > HPLC
- > Gas chromatography
- > AA micro-analysis
- > Mobile phase decontamination
- > Food and beverages industry
- > Pharma industry



Product	Features	Components	Application
V300A	<ul style="list-style-type: none"> > Modular design > Environmental friendly > Maintenance-free > Low noise > Added filters for enhanced pump longevity 	<ul style="list-style-type: none"> > Oil-free vacuum pump > VF6 filtration flask set > Silicone tube > Fiberglass filter membranes (47mm / 1 μm) > PTFE disc filter 	<ul style="list-style-type: none"> Water quality measurement Normal liquid filtration
V300B	<ul style="list-style-type: none"> > Modular design > Magnetic Stability Cup > Environmental friendly > Maintenance-free > Low noise > Added filters for enhanced pump longevity 	<ul style="list-style-type: none"> > Oil-free vacuum pump > VF1 magnetic filtration flask set > Silicone tube > Fiberglass filter membranes (47mm / 1 μm) > PTFE disc filter 	<ul style="list-style-type: none"> Suspended solids measurement Normal liquid filtration
V300SS	<ul style="list-style-type: none"> > Modular design > Flame-sterilizable > Spin-Lock system > Environmental friendly > Maintenance-free > Low noise > Added filters for enhanced pump longevity 	<ul style="list-style-type: none"> > Oil-free vacuum pump > VF2 filtration flask set > Dragon 100 lab burner > Silicone tube > Fiberglass filter membranes (47mm / 1 μm) > PTFE disc filter 	<ul style="list-style-type: none"> Microbiological detection All kinds of liquid filtration
C300A	<ul style="list-style-type: none"> > Chemical Resistance > Modular design > Environmental friendly > Low maintenance > Low noise > Added filters for enhanced pump longevity 	<ul style="list-style-type: none"> > Chemical resistant vacuum pump > VF3 filtration flask set > High-pressure resistant tube > PTFE disc filter 	<ul style="list-style-type: none"> Sample pretreatment for HPLC, GC, and AA analysis All kinds of solvent purification (mobile phase)

Specifications

Model	V300A	V300B	V300SS	C300A
Flow Rate of the Pump(l/min)	17 l/min	17 l/min	17 l/min	22 l/min
Ultimate Vacuum(mbar)	150 mbar	150 mbar	150 mbar	210 mbar
Filtration Glass Set	VF6	VF1	VF2	VF3
Suction Bottle Capacity(ml)	1000 ml	1000 ml	1000 ml	1000 ml
Filter Diameter(mm)	47/50 mm	47/50 mm	47/50 mm	47/50 mm
Filter Flask Capacity(ml)	300 ml	300 ml	100 ml	300 ml
Filter Flask Material	(Glass Filter Cup)	(Magnetic Filter Cup)	(Stainless Steel Filter Cup)	(Glass Filter Cup)
Effective Filtration Area(cm ²)	8 cm ²	9.6 cm ²	9.6 cm ²	8 cm ²
Tube I.D. (mm)	8 mm	8 mm	8 mm	8 mm
Order No.	167301	167302	167303	169301

Filtration Set

- > Vacuum filtration technique is widely used in liquid filtration in microbiological detection, suspended solid detection, sample pre-process or solvent purification, mostly for microanalysis of HPLC, GC, or AA in food, medicine, beverage, drinking water, etc.
- > This unique design combines a filtration funnel with a receiver flask with drain, together with magnetic weighted base, guaranteeing the efficiency and stability.

Model	VF1	VF2	VF3	VF5	VF6	VF7	VF8
Funnel	PES	SUS316	Borosilicate Glass	Borosilicate Glass	Borosilicate Glass	Borosilicate Glass	Borosilicate Glass
Funnel Base	PES	SUS316	Borosilicate Glass	Borosilicate Glass	Borosilicate Glass	Borosilicate Glass	Borosilicate Glass
Material Membrane Support	PP	SUS316	Borosilicate Glass	Borosilicate Glass	Borosilicate Glass	Stainless Steel Micro-Strainer	Stainless Steel Micro-Strainer
Stopper	Silicon	Silicon	--	Silicon	Silicon	Silicon	Silicon
Receiver Flask with Drain	Borosilicate Glass	Borosilicate Glass	Borosilicate Glass	Borosilicate Glass	Borosilicate Glass	Borosilicate Glass	Borosilicate Glass
Funnel Capacity	300 ml	100 ml	250 ml	15ml	250 ml	250 ml	15ml
Filtration Flask Capacity	1000 ml	1000 ml	1000 ml	125ml	1000 ml	1000 ml	125ml
Filter Diameter	47 mm	47 mm	47 mm	25mm	47 mm	47 mm	25mm
Effective Filtration Area	9.6 cm ²	9.6 cm ²	8 cm ²	2.2cm ²	8 cm ²	8 cm ²	2.2cm ²
Tube I.D. (mm)	8 mm	8 mm	8 mm	8 mm	8 mm	8 mm	8 mm

Drawing for filtration principle

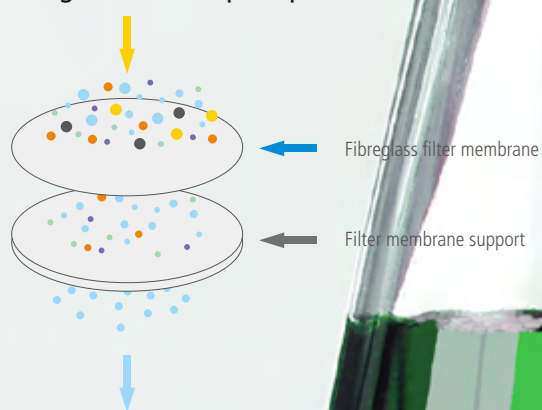

Model	VF9	VF10	VF11	VF12	VF30	VF32	VF33
Funnel	SUS316	Borosilicate Glass	SUS316	Borosilicate Glass	PES	SUS316	SUS316
Funnel Base	SUS316	Borosilicate Glass	SUS316	Borosilicate Glass	PES	SUS316	SUS316
Material Membrane Support	SUS316	Borosilicate Glass	SUS316	Borosilicate Glass	PP	SUS316	SUS316
Stopper	Silicon	--	Silicon	Silicon	Silicon	Silicon	Silicon
Receiver Flask with Drain	Borosilicate Glass	Borosilicate Glass	Borosilicate Glass	Borosilicate Glass	Borosilicate Glass	Borosilicate Glass	Borosilicate Glass
Funnel Capacity	300 ml	1000 ml	500 ml	250 ml	300 ml	100 ml	300 ml
Filtration Flask Capacity	1000 ml	4000 ml	2000 ml	1000 ml	1000 ml	1000 ml	1000 ml
Filter Diameter	47 mm	47 mm	47 mm	47 mm	47 mm	47 mm	47 mm
Effective Filtration Area	9.6 cm ²	9.6 cm ²	9.6 cm ²	9.6 cm ²	9.6 cm ²	9.6 cm ²	9.6 cm ²
Tube I.D. (mm)	8 mm	8 mm	8 mm	8 mm	8 mm	8 mm	8 mm

Order Information

300ml Magnetic Filtration set

47mm, PP membrane support

For solvent purification, general filtration and waste inhalation

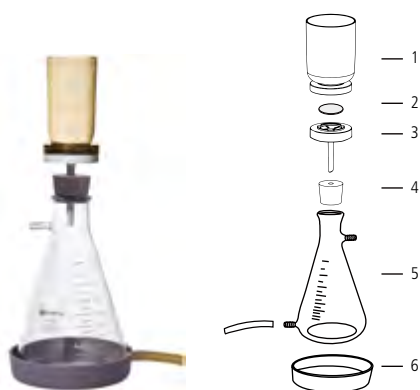

VF1

167200-01

Magnetic filter funnel 300 ml (1+2+3+4)	167100-18
1 300 ml Magnetic filter cup	167000-34
2 PP Membrane support	167000-37
3 PES Filtration base	167000-35
4 Silicone stopper	167110-16
5 Receiver flask with drain, 1000 ml	167300-08
6 Weighted base	167200-04

100ml Stainless Steel Filtration Set

47mm, Stainless steel membrane support

For filtration requiring the sterilization such as microbiology test or use for purification of corrosive liquid, solvent etc.



VF2

167200-02

100ml Stainless steel filter holder (1+2+3+4)	167103-10
1 Stainless steel funnel, 100 ml	167103-61
2 Stainless steel support screen	167100-31
3 Stainless steel support base	167103-60
4 Silicone stopper	167110-16
5 Receiver flask with drain, 1000 ml	167300-08
6 Weighted base	167200-04

300ml Stainless Steel Filtration Set

47mm, Stainless steel membrane support

For filtration requiring the sterilization such as microbiology test or use for purification of corrosive liquid, solvent etc.



VF9	167200-09
300ml Stainless steel filter holder (1+2+3+4)	167103-30
1 Stainless steel funnel, 300 ml	167103-63
2 Stainless steel membrane support	167100-31
3 Stainless steel support base	167103-60
4 Silicone stopper	167110-16
5 Receiver flask with drain, 1000 ml	167300-08
6 Weighted base	167200-04

500ml Stainless Steel Filtration Set

47mm, Stainless steel membrane support

For filtration requiring the sterilization such as microbiology test or use for purification of corrosive liquid, solvent etc.



VF11	167200-11
500ml Stainless steel filter holder (1+2+3+4)	167103-50
1 Stainless steel funnel, 500 ml	167103-65
2 Stainless steel membrane support	167100-31
3 Stainless steel support base	167103-60
4 Silicone stopper	167110-16
5 Receiver flask with drain, 2000 ml	167200-13

250ml Glass Filtration Set

47mm, Sintered glass membrane support

Ideal for the purification of organic, corrosive liquid such as solvent (mobile phase) for HPLC analysis.



VF3	167200-03
250ml Glass filter holder (1+2+3)	167120-30
1 Glass funnel, 250 ml	167210-03
2 Aluminum magnesium alloy clamp	167240-01
3 Glass support base & tubulated cap	167230-01
4 Ground joint flask, 1000 ml	167250-01

1000ml Glass Filtration Set

47mm, Sintered glass membrane support

Ideal for the purification of organic, corrosive liquid such as solvent (mobile phase) for HPLC analysis.

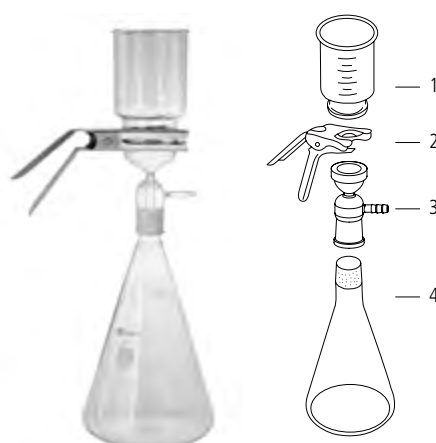

VF10	167200-10
1000ml Glass filter holder (1+2+3)	167210-35
1 Glass funnel, 1000 ml	167210-10
2 Anodized aluminum clamp	167240-01
3 Glass support base & tubulated cap	167230-01
4 Ground joint flask, 4000 ml	167250-06

15ml Small Volume Glass Filtration Set

25mm, Sintered glass membrane support

Ideal for small volume vacuum filtration for biological analysis or particulate contamination analysis.



VF5 167200-05

15 ml Glass filter holder (1+2+3+4)	167120-32
1 Glass funnel, 15 ml	167220-15
2 Anodized aluminum clamp	167240-05
3 Glass support base	167230-04
4 Silicone stopper	167110-18
5 125 ml Receiver flask	167250-05

15ml Small Volume Glass Filtration Set

25mm, Stainless steel membrane support

Ideal for small volume vacuum filtration for biological analysis or particulate contamination analysis.



VF8 167200-08

15 ml Glass filter holder (1+2+3+4+5)	167120-40
1 Glass funnel, 15 ml	167220-15
2 Anodized aluminum clamp	167240-05
3 Stainless steel support screen	167230-32
4 Glass support base	167230-08
5 Silicone stopper	167110-18
6 125 ml Receiver flask	167250-05

250ml Glass Filtration Set

47mm, Sintered glass membrane support

Ideal for solvent purification and general filtration for microbiology, suspended solid analysis etc.



VF6 167200-06

250ml Glass filter holder (1+2+3+4)	167120-31
1 Glass funnel, 250 ml	167210-03
2 Anodized aluminum clamp	167240-01
3 Glass support base	167230-03
4 Silicone stopper	167110-17
5 Receiver flask, 1000 ml	167250-03

250ml Glass Filtration Set

47mm, Stainless steel membrane support

Ideal for solvent purification and general filtration for microbiology, suspended solid analysis etc.



VF7 167200-07

250ml Glass filter holder (1+2+3+4+5)	167120-33
1 250 ml Glass Filter Cup	167210-03
2 Anodized aluminum clamp	167240-01
3 Stainless steel support screen	167230-31
4 Glass support base	167230-07
5 Silicone stopper	167110-17
6 Receiver flask, 1000 ml	167250-03

250ml Glass Filtration Set

47mm, Sintered glass membrane support

Ideal for the purification of organic, corrosive liquid such as solvent (mobile phase) for HPLC analysis.



Unique filtration Adapter design can connect with GL45 storage bottle (1000ml, 2000ml, 5000ml...etc.)

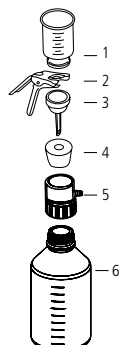

VF12	167200-12
250ml Glass filter holder (1+2+3+4)	167120-31
1 Glass funnel, 250 ml	167210-03
2 Anodized aluminum clamp	167240-01
3 Glass support base	167230-03
4 Silicone stopper	167110-16
5 Filtration adapter	167000-65
6 1000ml Glass storage bottle (Duran)	21801545

300ml PES Magnetic Filtration set

47mm, PP membrane support, float to prevent overflow

For general filtration and waste inhalation

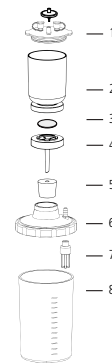

VF30	197010-30
Magnetic filter funnel 300 ml (2+3+4+5)	167100-18
1 PP Funnel Lid	167130-32
2 Magnetic filter cup, 300ml	167000-34
3 PP Membrane support	167000-37
4 PES support base	167000-35
5 Silicone stopper	167110-16
PC waste bottle with cover,1000 ml (6+7+8)	197000-11-PC
6 PC cover	197000-32-PC
7 Overflow protection	197000-39
8 PC bottle, 1000 ml	197000-31-PC

100ml Stainless Steel Filtration Set

47mm, Stainless steel membrane support, float to prevent overflow

For filtration requiring the sterilization such as microbiology test or use for purification of corrosive liquid, solvent etc.

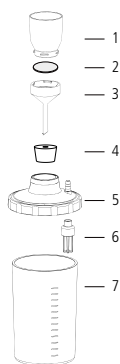

VF32	197010-32
100ml Stainless steel filter holder (1+2+3+4)	167103-10
1 Stainless steel funnel, 100 ml	167103-61
2 Stainless steel membrane support	167100-31
3 Stainless steel support base	167103-60
4 Silicone stopper	167110-16
PC waste bottle with cover,1000 ml (5+6+7)	197000-11-PC
5 PC cover	197000-32-PC
6 Overflow protection	197000-39
7 PC bottle, 1000 ml	197000-31-PC

300ml Stainless Steel Filtration Set

47mm, Stainless steel membrane support, float to prevent overflow

For filtration requiring the sterilization such as microbiology test or use for purification of corrosive liquid, solvent etc.

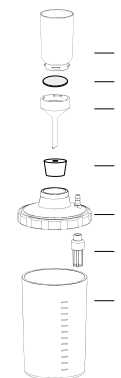

VF33	197010-33
300ml Stainless steel filter holder (1+2+3+4)	167103-30
1 Stainless steel funnel, 300 ml	167103-63
2 Stainless steel membrane support	167100-31
3 Stainless steel support base	167103-60
4 Silicone stopper	167110-16
PC waste bottle with cover,1000 ml (5+6+7)	197000-11-PC
5 PC cover	197000-32-PC
6 Overflow protection	197000-39
7 PC bottle, 1000 ml	197000-31-PC

Multi-Position Filtration System

Features

The manifold is made of SS316

All parts of a manifold are made of SS316 which are excellent chemical resistant and can be fast sterilized by autoclaving.

The spin-lock design

The manifold uses a spin-lock connection which facilitates fast and stable installation without clamps.

Individual control valve

Each branch permits individual control.

Compatible to different sizes of funnels

manifolds are available to fit 100, 300, 500ml funnel at your option.

Magnetic filter holder is included

Magnetic filter holder allows one-handed operation, and prevents possible twisting and tearing of the membrane.

Application

- > Biological laboratories
- > Microbiological detection
- > Chemical industry
- > All kinds of liquid filtration



Specifications

Model	BioVac330B	BioVac630B	BioVac320A	BioVac320B
Max. Flow Rate	34 l/min	58 l/min	34 l/min	34 l/min
Ultimate Vacuum(mbar)	150 mbar	150 mbar	150 mbar	150 mbar
Waste Bottle (Capacity in ml/ Material)	3000 ml, PC	3000 ml, PC	3000 ml, PC	3000 ml, PC
Number of Branches	3	6	3	3
Manifold Material	Stainless Steel	Stainless Steel	Stainless Steel	Stainless Steel
Filter Diameter(mm)	47 / 50 mm	47 / 50 mm	47 / 50 mm	47 / 50 mm
Filter Cup (Capacity in ml/ Material)	100 ml Stainless Steel	100 ml Stainless Steel	300 ml Magnetic	250 ml Glass
Effective Filtration Area(cm ²)	9.6 cm ²	9.6 cm ²	9.6 cm ²	9.6 cm ²
Tube I.D. (mm)	8 mm	8 mm	8 mm	8 mm

configuration

	Model	Order No.	Model	Order No.	Model	Order No.	Model	Order No.
Model	BioVac330B	167403	BioVac630B	167601	BioVac320A	167405	BioVac320B	167406
Contains								
Pump	V400	167400	V600	167600	V400	167400	V400	167400
Manifold	BioVac330 3-branch Stainless steel	167103-23	BioVac630 6-branch Stainless steel	167103-26	BioVac320 3-branch Stainless steel	167110-23	BioVac320 3-branch Stainless steel	167110-23
Filter Cups	3 x 100 ml Stainless steel	167103-61	6 x 100 ml Stainless steel	167103-61	3 x 300 ml PES (magnetic base)	167100-18	3 x 250 ml Glass	167120-31
Waste Bottle	3000 ml / PC	167200-33	3000 ml / PC	167200-33	3000 ml / PC	167200-33	3000 ml / PC	167200-33
Bunsen Burner	Dragon 100	177100-00	Dragon 100	177100-00	Without	Without	Without	Without
Filter Membranes	Pall GN-6 MCE *	167100-52	Pall GN-6 MCE *	167100-52	Pall GN-6 MCE *	167100-52	Pall GN-6 MCE *	167100-52
Silicon Tube	2 x 1m	168021-01	2 x 1m	168021-01	2 x 1m	168021-01	2 x 1m	168021-01

* Pall GN-6 MCE / 0.45µm, 200 pcs

Multi-Position Manifolds

Vacuum filtration is widely used in laboratory for various tests such as microorganism test in food, pharmacy, beverage, drinking water industries and suspended solid test in environment protection field, sample or solution pretreatment before HPLC, GC, AA analysis etc.

WIGGENS is one of the leading suppliers of vacuum filtration apparatuses in the world. WIGGENS manufactures quality and cost effective vacuum pumps, compressors, manifolds as well as funnels and filters for different applications, wiggens offer you total solution for vacuum filtration.

Features

The manifold is made of SS316

All parts of BioVac 330, 630 manifold are made of SS316. which are excellent chemical resistant and can be fast sterilized by flame and steam.

The spin-lock design

The manifold uses a spin-lock connection which facilitates fast and stable installation without clamps

Individual control valve

Each branch permits individual control.

Compatible to different sizes of funnels

BioVac 330 and 630 manifolds are available to fit 100, 300, 500ml funnel at your option.



3-branch stainless steel manifold BioVac330
Order No.: 167103-23



Stainless Steel Filter Cup (Cylinder Type)



3-branch Stainless Steel Manifold set (100ml, 300ml, 500ml)
Order No.: 167103-24, 167101-23, 167101-24

3-branch Stainless Steel Manifold set

Model	BioVac330	BioVac331	BioVac333	BioVac335
Order No.	167103-23	167103-24	167101-23	167101-24
Number of Branches	3	3	3	3
Filter Diameter(mm)	47/50	47/50	47/50	47/50
Effective Filtration Area	9.6 cm ²	9.6 cm ²	9.6 cm ²	9.6 cm ²
Tube I.D. (mm)	8	8	8	8
Dimensions(L×W×H) cm	50×15×15cm	80×15×20cm	50×15×23cm	50×15×26cm
Filter Cup Material	/	Stainless Steel	Stainless Steel	Stainless Steel
Filter Cup Capacity (mL)	/	100ml	300ml	500ml
Product Description	3-branch stainless steel manifold BioVac 330	3-branch stainless steel manifold BioVac 330 + 3 x 100ml Stainless Steel Filter Cups	3-branch stainless steel manifold BioVac 330 +3 x 300ml Stainless Steel Filter Cups	3-branch stainless steel manifold BioVac 330+3 x 500ml Stainless Steel Filter Cups



The 6-branch stainless steel manifold BioVac 630
Order No.: 167103-26



Stainless Steel Filter Cup (Cylinder Type)



6-branch Stainless Steel Manifold set BioVac 631
Order No.: 167103-27

6-branch Stainless Steel Manifold set

Model	BioVac630	BioVac631	BioVac633	BioVac635
Order No.	167103-26	167103-27	167101-26	167101-27
Number of Branches	6	6	6	6
Filter Diameter(mm)	47/50	47/50	47/50	47/50
Effective Filtration Area	9.6 cm ²	9.6 cm ²	9.6 cm ²	9.6 cm ²
Tube I.D. (mm)	8	8	8	8
Dimensions(L×W×H) cm	80×15×15	80×15×20	80×15×23	80×15×26
Filter Cup Material	/	Stainless Steel	Stainless Steel	Stainless Steel
Filter Cup Capacity (mL)	/	100ml	300ml	500ml
Product Description	6-branch stainless steel manifold BioVac 630	6-branch stainless steel manifold BioVac 630 + 6 x 100ml Stainless Steel Filter Cups	6-branch stainless steel manifold BioVac 630 +6 x 300ml Stainless Steel Filter Cups	6-branch stainless steel manifold BioVac 630+6 x 500ml Stainless Steel Filter Cups

Multi-Position Filtration Manifolds

3-branch Stainless Steel Manifold set



Model	BioVac320	BioVac341	BioVac343	BioVac345	BioVac351	BioVac353	BioVac355	BioVac363	BioVac364
Order No.	167110-23	167111-31	167111-33	167111-35	167112-31	167112-33	167112-35	167113-33	167113-34
Number of Branches	3	3	3	3	3	3	3	3	3
Filter Diameter(mm)	47/50	47/50	47/50	47/50	47/50	47/50	47/50	47/50	47/50
Effective Filtration Area	9.6 cm ²	9.6 cm ²	9.6 cm ²	9.6 cm ²	9.6 cm ²	9.6 cm ²	9.6 cm ²	9.6 cm ²	9.6 cm ²
Tube I.D. (mm)	8	8	8	8	8	8	8	8	8
Dimensions(L×W×H) cm	50×15×12	50×15×23	50×15×27	50×15×30	50×15×30	50×15×30	50×15×33	50×15×30	50×15×30
Filter Cup Material	Without	Stainless Steel	Stainless Steel	Stainless Steel	Magnetic	Magnetic	Magnetic	Borosilicate Glass	Glass funnel with Micro-Strainer
Filter Cup Capacity (mL)	Without	100	300	500	150	300	500	250	250

6-branch Stainless Steel Manifold set

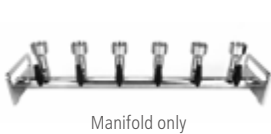

Model	BioVac620	BioVac641	BioVac643	BioVac645	BioVac651	BioVac653	BioVac655	BioVac663	BioVac664
Order No.	167110-26	167111-61	167111-63	167111-65	167112-61	167112-63	167112-65	167113-63	167113-64
Number of Branches	6	6	6	6	6	6	6	6	6
Filter Diameter(mm)	47/50	47/50	47/50	47/50	47/50	47/50	47/50	47/50	47/50
Effective Filtration Area	9.6 cm ²	9.6 cm ²	9.6 cm ²	9.6 cm ²	9.6 cm ²	9.6 cm ²	9.6 cm ²	9.6 cm ²	9.6 cm ²
Tube I.D. (mm)	8	8	8	8	8	8	8	8	8
Dimensions(L×W×H) cm	80×15×12cm	80×15×23cm	80×15×27cm	80×15×30cm	80×15×30cm	80×15×30cm	80×15×33cm	80×15×30cm	80×15×30cm
Filter Cup Material	Without	Stainless Steel	Stainless Steel	Stainless Steel	Magnetic	Magnetic	Magnetic	Borosilicate Glass	Glass funnel with Micro-Strainer
Filter Cup Capacity (mL)	Without	100	300	500	150	300	500	250	250

Customized Assembling Options for Multi-Position Filtration System

Wiggins offers free assembling options, allowing customers to design their own filtration system based on different application requirements.

Filtration System Components Package I

Vacuum pump ①、PP/PC Waste Bottle ②、Filter Membranes ④、Silicon Tubing ⑤、Filtration combination ⑥



Multi-Position Filtration System

Configuration Table for Multi-Position Filtration System

No.	Name				
1	Vacuum pump	V400	V600	V410	V610
	Order No.	167400	167600	167410	167610
2	Suction bottle	1000ml	2000ml	3000ml	-
	Order No.	167200-31	167200-32	167200-33	-
4	Filter Membranes	Fiberglass Filter Membranes	MCE Filter Paper	-	-
	Order No.	167100-20	167100-52	-	-
5	Silicon Tubing	Outer Diameter 14mm, Inner Diameter 8mm, Length 1m		-	-
	Order No.	167021-01		-	-
6	Combination	BioVac351, BioVac353, BioVac355, BioVac363, BioVac364, BioVac651, BioVac653, BioVac655, BioVac663, BioVac664, BioVac311, BioVac313, BioVac315, BioVac301, BioVac303, BioVac305, BioVac323, BioVac324,			

Filtration System Components Package II

Vacuum pump ①、PP/PC Waste Bottle ②、Lab Burners ③、Filter Membranes ④、Silicon Tubing ⑤、Filtration combination ⑥



Multi-Position Filtration System

Configuration Table for Multi-Position Filtration System

No.	Name				
1	Vacuum pump	V400	V600	V410	V610
	Order No.	167400	167600	167410	167610
2	Suction bottle	1000ml	2000ml	3000ml	-
	Order No.	167200-31	167200-32	167200-33	-
3	Lab Burners	Dragon 100	Dragon 220	-	-
	Order No.	177100-00	177220-00	-	-
4	Filter Membranes	Fiberglass Filter Membranes	MCE Filter Paper	-	-
	Order No.	167100-20	167100-52	-	-
5	Silicon Tubing	Outer Diameter 14mm, Inner Diameter 8mm, Length 1m		-	-
	Order No.	167021-01		-	-
6	Combination	BioVac331, BioVac333, BioVac335, BioVac631, BioVac633, BioVac635, BioVac341, BioVac343, BioVac345, BioVac641, BioVac643, BioVac645			

Accessories For Filtration System

47mm Glass Funnel Holder

Features

- > Made of chemical-resistant borosilicate glass
- > High temperature resistant
- > Autoclavable

Specifications

Materials	Glass Funnel	Glass funnel with support screen
Funnel	Borosilicate Glass	Borosilicate Glass
Funnel Base	Borosilicate Glass	Borosilicate Glass
Membrane Support	Sintered Glass	Stainless Steel Support Screen + PTFE Gasket
Clamp	Aluminum	Aluminum

Type		
Funnel Capacity(ml)	250 ml	250 ml
Filter Diameter(mm)	47 mm	47 mm
Effective Filtration Area(cm ²)	9.6 cm ²	9.6 cm ²

Ordering Information

47mm Glass Funnel	167120-31
250ml Glass Filter Cup	167210-03
Aluminum Clamp	167240-01
47mm Glass Filter Base	167230-03
Silicon Rubber	167110-16



Glass Funnel



47mm Glass Funnel with Micro Strainer	167120-33
250ml Glass Filter Cup	167210-03
Aluminum Clamp	167240-01
Stainless Steel Support Screen	167230-31
47mm Glass Filter Base	167230-07
Silicon Rubber	167110-16



Glass funnel with support screen

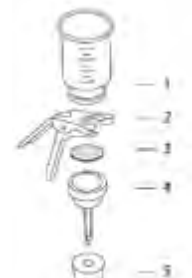

PES Funnels With Magnetic Base

- > Unique magnetic connection design
- > No clamps needed
- > High temperature sterilization possible

Materious	
Filter Cup	PES
Membrane Support	PP
Filter Base	PES
Rubber	Silicon

Specifications	
Magnetic filter funnel 150 ml	167130-15
Magnetic filter funnel 300 ml	167100-18
Magnetic filter funnel 500 ml	167130-50



47mm Stainless Steel Funnel

- > Quick and effective spin-lock system
- > No clamp needed
- > SUS316 stainless steel
- > Heat sterilization can be applied



Specification

Materious	100 ml	300 ml	500 ml
Funnel	SUS316	SUS316	SUS316
Funnel Base	SUS316	SUS316	SUS316
Membrance Support	SUS316	SUS316	SUS316
Funnel Lid	SUS316	SUS316	SUS316
Type			
Funnel Capacity(ml)	100 ml	300 ml	500 ml
Filter Diameter(mm)	47 / 50 mm	47 / 50 mm	47 / 50 mm
Effective Filtration Area(cm ²)	9.6 cm ²	9.6 cm ²	9.6 cm ²

Ordering Information

100 ml Stainless Steel Funnel	167103-10
100ml stainless steel filter cup	167103-61
Stainless Steel Support Screen	167100-31
47mm stainless steel filter base	167103-60
Silicon Rubber	167110-17
300 ml Stainless Steel Funnel	167103-30
300 ml	167103-63
Stainless Steel Support Screen	167100-31
47mm stainless steel filter base	167103-60
Silicon Rubber	167110-17
500 ml Stainless Steel Funnel	167103-50
500ml stainless steel filter base	167103-65
stainless steel Support Screen	167100-31
47mm stainless steel filter base	167103-60
Silicon Rubber	167110-17

Stainless Steel Filter Cup (Cylinder Type)



Order No.	167103-61	167103-63	167103-65
Filter Cup	SUS316	SUS316	SUS316
Funnel Capacity(ml)	100 ml	300 ml	500 ml
Filter Diameter(mm)	47 / 50 mm	47 / 50 mm	47 / 50 mm
Effective Filtration Area(cm ²)	9.6 cm ²	9.6 cm ²	9.6 cm ²
Suitable for	BioVac 330/630	BioVac 330/630	BioVac 330/630

Stainless Steel Filter Cup (Cone Type)



Order No.	167102-50	167102-75	167102-99
Filter Cup	SUS316	SUS316	SUS316
Funnel Capacity(ml)	500 ml	700 ml	1000 ml
Filter Diameter(mm)	47 / 50 mm	47 / 50 mm	47 / 50 mm
Effective Filtration Area(cm ²)	9.6 cm ²	9.6 cm ²	9.6 cm ²
Suitable for	BioVac 300/600	BioVac 300/600	BioVac 300/600

Stainless Steel Funnel Lid



Description	Order No.
100 ml Stainless Steel Funnel Lid, Suitable for 100 ml Stainless Steel Filter Cup (Cylinder Type)	167103-11
300 ml Stainless Steel Funnel Lid, Suitable for 300 ml Stainless Steel Filter Cup (Cylinder Type)	167103-13
500 ml Stainless Steel Funnel Lid, Suitable for 500 ml Stainless Steel Filter Cup (Cylinder Type)	167103-15
Stainless Steel Funnel Lid, Suitable for 500 ml / 750 ml / 1000 ml Stainless Steel Filter Cups (Cone Type)	167110-20

PP Funnel Lid



Order No.	167130-32	
Specification	Material	
Suitable for Funnel	Pall 4242	Main Body PP
Number of Inlets	3	Cover Silicon
Inlet Type	Female luer slip	Filter Material PTFE
Filter Diameter	25 mm	Pore Size 0.2 μm
Package	1	

Filtration Flask for Liquids

Order No.	167100-13	167100-14
Includes		
Glass bottle	167300-08	167300-08
Rubber stopper	167110-16	167110-17
Magnetic base	167200-04	167200-04
Specification		
Capacity	1000 ml	1000 ml
Inlet / Outlet Diameter	8 mm	8 mm
Water Outlet	Yes	Yes
The diameter of hole in center of rubber stopper	Ø15mm	Ø9.5mm



Weighted Base

Description	Order No.
1000 ml Filtration Flask Base with a Unique Stabilization Design	167200-04



Disc Filter

Name	Pinhead Filter	Small Disc Filter	Big Disc Filter
Order No.	194225-01	167200-35	167200-36
Brand	Pall	Pall	Pall
Filter Diameter / Pore Size	25 mm / 0.2 µm	37 mm / 0.2 µm	50 mm / 0.2 µm
Outer Diameter	30 mm	45 mm	73 mm
Material	PTFE	PTFE	PTFE
Outer Material	PP	PP	PP
Number of Filters per Package	1	1	1



Filter Membranes

Name	Fiberglass Filter Membranes	MCE Filter Paper
Order No.	167100-20	167100-52
Brand	Pall	Pall
Filter Diameter	47 mm	47 mm
Filter Pore Size	1 µm	0.45 µm
Material	Fiberglass	MCE
Number of Filters per Package	100	200



Silicon Tubing

Order No.	Outer Diameter (mm)	Inner Diameter (mm)	Thickness (mm)	Length (m)
168020-01	12	6	3	1
168021-01	14	8	3	1
168022-01	16	10	3	1



PP/PC Waste Bottle

Material					
Order No.	167201-31	167200-31	167201-32	167200-32	167200-33
Bottle	PC	PC	PC	PC	PC
Bottle Cover	316L	PC	PC	PC	PC
Spill-Proof Buoy	PP	PP	PP	PP	PP
Description					
Capacity(ml)	1000 ml	1000 ml	1500 ml	2000 ml	3000 ml
Outlet(mm)	8 mm	8 mm	8 mm	8 mm	8 mm
Spill-Proof Buoy	Yes	Yes	Yes	Yes	Yes
Autoclavability (121°C)	Yes	Yes	Yes	Yes	Yes

Glass Waste Bottle

Description	Material		
Order No.	167120-34		
Capacity	4000 ml	Bottle	PC
Outlet	8 mm	Bottle Lid	ABS
Spill-Proof Buoy	Yes	Float Switch	PP
Autoclavability (121°C)	Yes		



Stand for Waste Bottle

Description	Order No.
Stand for waste bottle designed for Stabilizing the bottle in filtration work	167200-39



Foot Pedal

Description	Order No.
Suitable for C series and V series vacuum pumps	167200-41

Silicon Drainage Tubing

Order No.	Outer Diameter (mm)	Inner Diameter (mm)	Thickness (mm)	Length (m)
168030-01	12	8	2	1

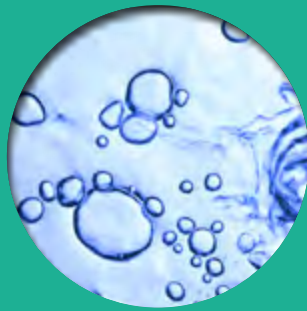

Liquid Handling Equipment

Peristaltic Pump

Advancing the Science of Liquid Handling



Advanced Control Features

- > Icon Driven User Interface allows for easy setup and operation
- > Large Backlit LCD Display is easy to view from a distance
- > Durable Front Overlay is resistant to chemicals
- > Polarized and Angled Screen allows for glare free viewing
- > "Trouble-Free" Calibration Screen allows for accurate and quick calibration
- > Ultra High Precision Stepper Motor ensures repeatability and accuracy

User-Friendly Design Features

- > Low Profile Design reduces space required on the bench or in a hood
- > Pump Settings can be saved and recalled saving time in multi-use settings. Nine quick retrieval setups are available
- > Multi-Language Help Screens: English, Chinese, Deutsch, Francaise, Japanese, Korean, and Spanish

Vdose® ELITE Additional Features

- > Multiple stacking pump heads allow for higher volumes and multiple fill applications with one pump
- > Microcassette head is ideal for precision micro-dispensing of liquids in well plates, microtubes, or microcentrifuge tubes
- > Works with 2, 3, 6 and 8mm tubing
- > Pump allows for different ramping profiles to avoid splashing or foaming
- > Accommodates a variety of dispensing and process applications

Suggested Applications

Research, Development, and Quality Control

Transfer and distribution of fluids into smaller containers, serial dilutions, sample preparation, and media dispensing.

Pharmaceutical and Biotechnology

Dispensing microbiological media, pill coating, dilutions, transferring live cells, additions and harvests to and from bioreactors, packaging and filling.

Food and Beverage

Common uses include dispensing flavorings, colorings, vitamins, and other additives in processing applications, and simple dispensing of end products on production lines or into shelf packages.

Waste Water and Sample Collection

Industrial and QC applications, environmental compliance hazardous/toxic materials evaluation and site sampling for liquids, sludge, earth/soil, water, etc. Ideal for sampling from barrels and drums.

International

The Icon Driven display and multi-language help screen work well in laboratories abroad.

Functionality	Vdose® PRO	Vdose® ELITE
Modes	Dispense Mode	Dispense Mode and Flow Mode
Motor	Dual Speed 75 and 150 Rpm	Variable Speed 0.5 to 400 Rpm
Direction	Unidirectional; Clockwise	Bidirectional; Clockwise and Counterclockwise
Ramp	Not Offered	User Ramp Control for Dispense and Flow Modes 5 Profiles
Drawback	Not Offered	For Filling into a Closed Container
Pump Heads	Single	Single, Dual, Microcassette
Order No.	W1100100	W1100200

Technical Specification

Model Pump	VAC	WATTS	Operating Speed Rpm	Tubing Sizes Available (mm ID)	Dispense Ranges for Tubing mL	Flow Rate Ranges for Tubing mL/min	Accuracy Midrange	Delay Time / Sec	Dim. with Pump Head (HxWxD)	Optional Pump Head Support
Vdose® ELITE	100-240	37	0.5-400	2	0.01-9999.99	20.4-174	≤±1%	0.5-99.9	18×21×34	> Stack up to 2 Pump Heads
				3	0.01-9999.99	60-330	≤±1%			> Stacking Pump Head for 2.3mm Wall Tubing
				6	0.01-9999.99	270-1080	≤±2.5%			> Pump Head for 1.6mm Wall Tubing
				8	0.01-9999.99	200-1746	≤±2.5%			> Stacking Pump Head for 1.6mm Wall Tubing
Vdose® PRO	100-240	37	75&150	2	0.01-9999.99	30&60	≤±1%	0.5-99.9	18×21×34	> 5-Channel Pump Head for Small-Bore Tubing
				3	0.01-9999.99	60&120	≤±2%			> Pump Head for 1.6mm Wall Tubing
				6	0.01-9999.99	210&426	≤±2%			> Stacking Pump Head for 2.3mm Wall Tubing
				8	0.01-9999.99	540&1080	≤±2.5%			



Home Screen

Calibration Screen

Dispensing Screen

Optional Pump Heads

Order No.	Description	Qty/Case
W1100101	Single Pump Head for 2.3mm Wall Tubing	1
W1100201	Optional Stacking Pump Head for 2.3mm Wall Tubing	1
W1100102	Optional Pump Head for 1.6mm Wall Tubing	1
W1100202	Optional Stacking Pump Head for 1.6mm Wall Tubing	1
W1100203	Optional 5-Channel Pump Head for use with Small Bore with fixed stops	1

Peristaltic Pumps Accessories

Order No.	Description	Qty/Case
Tubing Accessories		
374322	Hose Barb/Luer Adapter (fits 2 and 3mm)	1
W1100104	Footswitch	1
374324	2 and 3mm Polypropylene Nozzle	6
374326	6mm Polypropylene Nozzle	6
374328	8mm Polypropylene Nozzle	6
374320	Small Glass Sinker (fits 2 and 3mm ID tubing)	6
374321	Large Glass Sinker (fits 6 and 8mm ID tubing)	6
Tubing Support Stand		
W1100105	Tubing Support Stand	1
Silicone Tubing Assembly, 2.3 mm wall thickness		
374310	2mm ID, 5 ft Section (1.5m)	1
374311	3mm ID, 5 ft Section (1.5m)	1
374313	6mm ID, 5 ft Section (1.5m)	1
374314	8mm ID, 5 ft Section (1.5m)	1
Silicone Tubing, 2.3mm wall thickness		
374304	2mm ID, 25 ft Section (7.62m)	1
374305	3mm ID, 25 ft Section (7.62m)	1
374306	6mm ID, 25 ft Section (7.62m)	1
374308	8mm ID, 25 ft Section (7.62m)	1
Microtest Manifolds		
851380	4 Position, Straight, 24 Well	1
851381	8 Position, Straight, 96 Well	1
851382	4 Position, Angular, 24 Well	1
851383	8 Position, Angular, 96 Well	1
851388	12 Position, Straight, 96 Well	1
851389	12 Position, Angular, 96 Well	1
Dispensing Cannulas w/Luer Lock		
851411	18 Gauge x 2 in	1
851412	14 Gauge x 4 in	1



Microcassette Pump Head



Stacking Pump Head with Standard Pump Head

Stacking Pump Head

Hose Barb/Luer Adapter

The luer adapter allows connection to equipment and components with a female luer connector.



Tubing Support Stand

Optional tubing support stand conveniently holds the tubing in place for filling operations.



Footswitch

Utilize the convenience of a handsfree pump by installing the optional footswitch.



Silicone Tubing

Assembly consists of 1.5m (5-foot) section of silicone tubing with a wall thickness of 2.3mm, a borosilicate glass sinker, and a polypropylene delivery nozzle. Bulk tubing is also available.



Polypropylene Nozzle & Glass Sinker

- > The nozzle connects to the pump tubing for dispensing of liquids.
- > The glass sinker is used to secure tubing when drawing from a container.



Microtest Manifolds & Dispensing Cannulas

Ideal for use with 24 and 96 well microplates. This unique dispensing system enables you to perform sample inoculations and cell feedings faster and more efficiently under sterile conditions.



Portable Suction Unit (Aspirator)

Adopts oil-free vacuum pump

No lubricant required, maintenance-free, low noise and durable.

Double overflow protection

A built-in float switch plus 0.2 μm PTFE hydrophobic disc filter between the suction bottle and the pump prevent the medium and bacteria from flowing into the pump.

Autoclavable

Waste bottles and disc filters are autoclavable.

- > The whole unit is made of ABS plastic and aluminum alloy.
- > Various precision elements are developed, and assembled through long time test.
- > Piston pump inside offers low noise, and it is wear-resistant, pollution-free, maintenance-free.

High-Temperature Sterilization

Waste bottle and disc filter can resist high-temperature and high-pressure sterilization

Employment of an Oil-Free Vacuum Pump

The oil-free vacuum pump is maintenance-free, features a very low noise level and high-pressure sterilization and works stably

Double Protection Against Liquid Overflow

- > Waste bottle, floating ball.
- > 0.2 μm PTFE disc filter
- > Protection against liquid overflow
- > Keeps liquid from entering the pump.

Vacuum Regulator

Deliver the correct vacuum for various applications

Stable and Durable Casing

The casing is made of ABS material, which is light and easy to clean

Wire Storage Box

The system provides a storage for the foot switch wire, which makes it easy and convenient to use

Certification



BioVac 225



BioVac 235



BioVac 240

Application

- > Biochemical cultivation
- > Separation of culture fluids
- > Waste liquid suction in cell cultivation
- > All kinds of waste liquid suction in laboratory environments

Single-branch suction head



1

Handheld controller



2

8-branch "tip" plastic suction head



3

Single-branch stainless steel suction head



4

Specifications

Order No.	Model series	Power W	Ultimate Vacuum mbar	Max. Flow Rate L/min	Foot Switch	Dimensions cm	Suction bottle	Weight kg	Accessories included
W1080225	BioVac 225	25	100	25	-	37 × 15 × 25	1000mL X 1	4.3	4
W1080226	BioVac 225 PLUS	25	100	25	-	37 × 15 × 25	1000mL X 1	4.3	1.2.3.4
W1080235	BioVac 235	25	100	35	-	27 × 30 × 28	1500mL X 2	6.9	4
W1080236	BioVac 235 PLUS	25	100	35	-	27 × 30 × 28	1500mL X 2	6.9	1.2.3.4
W1080240	BioVac 240	25	80	40	yes	54 × 26 × 35	3000mL X 1	12	4
W1080241	BioVac 240 PLUS	25	80	40	yes	54 × 26 × 35	3000mL X 1	12	1.2.3.4

Accessories

Bio-Suction Kit

Successful removal of supernatants from lab containers by means of a vacuum aspiration system depends on applying the correct level of vacuum and on using an aspirator tip that matches the size and form of the container from which liquid is aspirated. The vacuum aspiration tool is produced by Wiggins to specifically match the diversity of laboratory containers. Different adapters fit on the hand operator so that your vacuum source is converted into a flexible system for aspirating liquids from tubes, dishes, bottles, T-flasks, 24-well and 96-well plates.

Quick-lock design

Ergonomic handle and friendly designed lock switch can keep continuous suction without pressing button all the time.

Single-handed tip ejection

The innovative tip ejection design enables tip ejection by a single hand easily.

Quick fitting change

Quick connection coupling between fitting and handle can make any fittings replaced quickly.

Vapor sterilization can be applied

The complete kit except the rack are made of POM and stainless steel material available for autoclave.



Specifications

No.	Order No.	Name	Quantity
1	167200-42	Single-branch suction head	1
2	167200-44	Single-branch stainless steel suction head	1
3	167200-45	Single-branch "tip" plastic suction head	1
4	167200-46	Handheld controller	1
5	167200-47	8-branch stainless steel suction head	1
6	167200-48	8-branch "tip" plastic suction head	1
7	167200-49	ABS Depositing rack	1

Name	Bio-Suction Kit
Order No.	167200-37
Operation Form	Vacuum Suction
Outlet Diameter(mm)	5 mm



Disc Filter

Name	Small Disc Filter	Big Disc Filter
Order No.	167200-35	167200-36
Filter Diameter / Pore Size	37 mm / 0.2 μm	50 mm / 0.2 μm
Outer Diameter	45 mm	73 mm
Material	PTFE	PTFE
Outer Material	PP	PP
Number of Filters per Package	1	1
Suitable for	BioVac225 / BioVac235	BioVac240

Silicon Tubes

Order No.	Outer Diameter mm	Inner Diameter mm	Thickness mm	Length m
168021-01	14	8	3	1
168022-01	16	10	3	1



167200-50



167200-51

Order No.	Name	Description
167200-50	Manual suction tube	The outer diameter of the connector is 8mm, The outer diameter of the PP tube is 5mm
167200-51	High pressure silicone tube	For the tube, the outer diameter is 10mm, and the inner diameter is 6mm, with hose joints at both ends



167200-52

Order No.	Name	Description
167200-52	Plastic stoppers	Suitable for the tube of which the outer diameter is 10mm or 12mm



PP/PC Waste Bottle

Material	167200-31	167201-32	167200-34
Order No.	167200-31	167201-32	167200-34
Bottle	PC	PC	PC
Bottle Cover	PC	PC	PC
Spill-Proof Buoy	PP	PP	PP
Description			
Capacity(ml)	1000 ml	1500 ml	3000 ml
Outlet(mm)	8 mm	8 mm	8 mm
Spill-Proof Buoy	Yes	Yes	Yes
Autoclavability (121°C)	Yes	Yes	Yes
Suitable for	BioVac225	BioVac235	BioVac240 / 350 / 650

If you need other bottles of different volumes, please choose 167200-39 below



Stand for Suction Bottles

Order No.	Description	Capacity
167200-39-1	Stand for suction bottles, designed for stabilizing	1000mL
167200-39-2	the bottle in filtration work	1500mL
167200-39-3		3000mL

Foot Pedal

Order No.	Description
167200-40	Foot Pedal, Suitable for BioVac240
167200-41	Foot Pedal, Suitable for BioVac225 / BioVac235



Vdose Syringe Pump

The standard syringe pump includes injection element and controller, and the injection element can be single-channel or dual-channel. Vdose serial syringe pump can carry out accurate liquid transmission automatically. The system is also programmable with a PC to realize more complicated liquid dosing operations.

- > Bright TFT display can show the dosing parameters clearly on one screen
- > 9 types of syringes can be selected, from 50µl~25ml, it is easy to change the syringes
- > Dosing speed: from 1.25µl/min to 375ml/min
- > All parts contacted with the liquid are glass or PTFE, which guarantees the chemical resistance
- > The three port valve can switch automatically to complete the repeating withdrawing and dosing
- > The valve ports can be configured for convenient liquid recovery without taking part the tubing
- > RS-232/485 digital communication ports available for remote PC or PLC control



Vdose4200

Specifications

Model	Vdose4200	Vdose4400
Number of dosing channel	Single Position	Dual Position
Flow Rate	1.25 µl/min~375 ml/min	1.25 µl/min~375 ml/min
Precision	≤ 5 ‰	≤ 5 ‰
Weight	5.5 kg	9.1 kg
Outer Dimensions (H x W x D mm)	305 x 89 x 330	305 x 178 x 330
Syringe	Size	50µl~25 ml
	Material	Glass and Teflon wetted
	Dispense Resolution	1/6000 of the syringe size in use
	Feature	Easily interchangeable
Valve	Material	PTFE
	Feature	3 to 8 selectable ports
Interface Port	RS232 / 485	RS232 / 485
Electric requirements	110~240V,50/60Hz	110~240V,50/60Hz
Order No.	V900705	V900704

Vdose 4200 and Vdose 4400 are more suitable for corrosive solvents



Vdose4400

Order Information

Order No.	Description
V900703	Single Position Syringe pump, with dosing unit and controller (need to specify the valve ports and glass syringe volume)
V900702	Dual Position Syringe pump, with dosing unit and controller (need to specify the valve ports and glass syringe volume)
Accessories	
V900700-5	50µL glass syringe with Teflon plunger
V900700-6	100µL glass syringe with Teflon plunger
V900700-7	250µL glass syringe with Teflon plunger
V900700-8	500µL glass syringe with Teflon plunger
V900700-9	1mL glass syringe with Teflon plunger
V900700-10	2.5mL glass syringe with Teflon plunger
V900700-11	5mL glass syringe with Teflon plunger
V900700-12	10mL glass syringe with Teflon plunger
V900700-13	25mL glass syringe with Teflon plunger
PTFE Tubing and Fittings	
V900700-19	Tubing Length: 6m; Outer Diameter: 1/8" ; Includes: 6 nuts and 6 ferrules
V900700-20	Tubing Length: 30m; Outer Diameter: 1/8" ; Includes: 6 nuts and 6 ferrules
V900700-21	Tubing Length: 6m; Outer Diameter: 1/16" ; Includes: 6 nuts and 6 ferrules
V900700-22	Tubing Length: 30m; Outer Diameter: 1/16" ; Includes: 6 nuts and 6 ferrules





Hot Plate / Stirrer
Dry Bath / Heating Mantle

Laboratory Hotplate Stirrer

Attractive design for demanding heating & mixing application

Our new complete range of laboratory hotplate stirrers will meet your high demands every day!



More Powerful Units

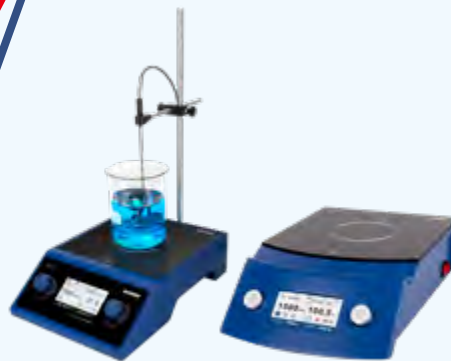

WH380 / WH385

WH390/ WH395-NH/ WH395

Intelligent heating technology for your very demanding applications
UP to 1800W heating power



WH280-AH

WH280-H

WH280-R

WH280-NH

Elite series
High bright TFT touch screen
Intelligent Cascade Control
Two external sensors can be connected
USB interface

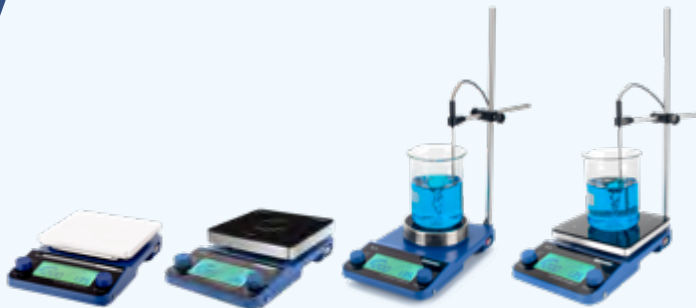

WH260-AH

WH260-H

WH260-R

WH260-NH

Pro series
large and clear LCD display
Intelligent PID
USB interface



WH200

WH210

WH220

WH420

WH620

New entry level for lab heating & mixing
Multi-position heating & mixing



Hot Plate



Why Infrared Radiation Heating?

Infrared radiation heating refers to the spectrum between 0.7 μ m-100 μ m of light waves, emission and transmission accompanied by obvious, directional energy transmission. The energy transmission does not need any media, even in vacuum space. The infrared heating uses an electromagnetic wave with a wavelength of 2.5 to 15 μ m. This speed is much higher than the rate of conduction and convection.

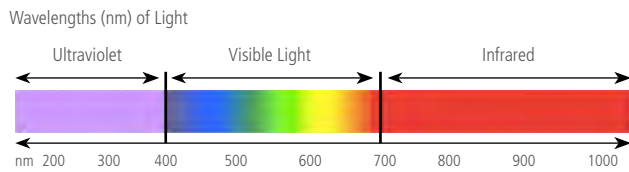

The magnetic heating stirrer, with its advanced infrared radiation technology, is characterized by direct, clean and safe heating. Thanks to this radiation heating technology, WIGGENS hotplate-stirrer can be used for speedy heating up for various shaped vessels including round-bottom flasks, and the solution inside can be heated up to Max. 450 $^{\circ}$ C in a very short time. Specifically, compared to oil heating, infrared radiation heating free from splashed bath oil ensures a direct and clean heating.

The high infrared permeability ensures that the heating energy is transferred quickly and with very limited loss, i.e. it heats liquids fast and thus saves time and energy. PID control or advanced ICC technology enable good temperature stability. If the Pt-100 sensor is connected, temperature-controlled work with stability of ± 2 $^{\circ}$ C can be reached in most applications.

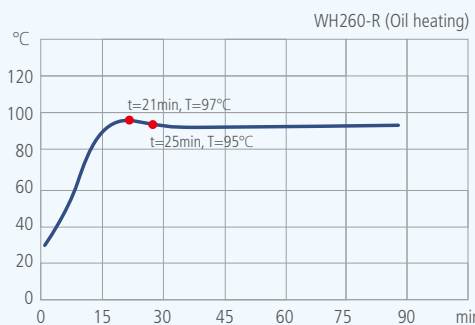
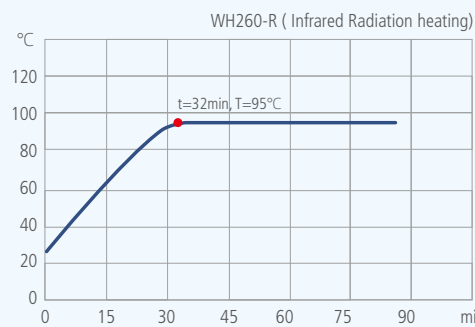

Glass bath :
Used for sample splashing
or other accidents occurring
protection



Wiggins IR Heating



Oil bath



Wiggins IR Heating (Oil Bath)



Disadvantages of conventional heating method

Digital Hot Plate / Stirrer

New entry level for lab heating & mixing

WH200 / WH210 / WH220

- > Our laboratory hotplates / stirrers are developed and produced according to high international quality standards.
- > Advanced microprocessor controlling system guarantees the reliability and temperature stability.
- > Bright and clear LED digital display and setting for the working temperature and stirring speed.
- > Memory function for stirring speed and temperature setting, convenient for experiments with fixed conditions.
- > Liquid drainage above the control board to prevent liquids from accessing the system.
- > Direct connection for thermocouple sensor for convenient solution temperature control.
- > WH200 and WH210 are suitable for general laboratory application.
- > WH220 with sealed outer shell and isolated critical parts design even can be used in a harsh laboratory environment.
- > When the temperature of the top plate is above 60°C , hot-top indicator will light up for the user's safety protection.



Standard thermocouple sensor
Accurate solution temperature within $\pm 2^{\circ}\text{C}$ in general range.



Safety protection
Flashing high temperature indicator, warning for hurt by touch



Temperature and Speed display
WH200 and WH210 display temperature and speed at the same time, and remember the last working parameters



Liquid drainage
Above the control board
Avoid the solution splashing on the touch board.



Temperature and Speed display
WH220 displays temperature and speed at the same time, and remembers the last working parameters



Top plate material
WH200 with aluminum plate, WH210 with SS304 plate. WH210 and WH220 SS304 coated with ceramic



Specifications

Model	WH200	WH210	WH220
Order No.	400302	400402	400400
Maximum temperature setting [$^{\circ}\text{C}$]	250	250	380
Maximum temperature setting with E-sensor [$^{\circ}\text{C}$]	250	250	380
Safety temperature [$^{\circ}\text{C}$]	280	280	50~430 adjustable
Temperature stability with E-sensor [$^{\circ}\text{C}$]	± 2	± 2	± 2
Heat output [W]	300	500	500
External temperature sensor	Thermocouple	Thermocouple	Pt100
PID parameter	1 set	1 set	2 sets
Speed setting range [rpm]	100~1500	100~1500	100~1500
Temperature and Speed display	LED display	LED display	LCD display
Temperature and Speed setting	Turning knob	Turning knob	Turning knob
Top plate material	Aluminium alloy	Stainless steel coated with ceramic	Stainless steel coated with ceramic
Top plate dimensions [mm]	165 x150	180 x145	180 x145
Dimensions W x D x H [mm]	230X200X100	270X230X100	230X200X100
Weight [kg]	1.5	3.0	3.1
Power supply	220V/50Hz	220V/50Hz	220V/50Hz

Digital Hot Plate / Stirrer

Multi-position heating & mixing

WH420 / WH620

- > Advanced microprocessor controlling system guarantees the reliability and temperature stability
- > Bright and clear LED digital display and setting for the working temperature, stirring speed, working time, and safety temperature
- > Memory function for stirring speed and temperature setting, convenient for experiments with fixed conditions
- > Liquid drainage above the control board to prevent liquids from accessing the system
- > Direct connection for Pt100 temperature sensor for convenient solution temperature control
- > Sealed outer shell and isolated critical parts design for enhanced longevity even in a harsh laboratory environment
- > When the temperature of the top plate is above 60°C, hot-top indicator will light up for the user's safety protection



Standard PT100 temperature sensor
Accurate solution temperature within $\pm 2^{\circ}\text{C}$ in general range.



Safety protection
Flashing high temperature indicator, warning for hurt by touch.



LED selectable
Display temperature and speed at the same time, and remember the last working parameters



Liquid drainage
Above the control board
Avoid the solution splashing on the touch board.



Ceramic top plate
Great anti-corrosive ability to acid, base, or organic solvents.



Specifications

Model	WH420	WH620
Order No.	400315	400316
Number of stirring positions	4	6
Maximum temperature setting [$^{\circ}\text{C}$]	300	300
Maximum temperature setting with E-sensor [$^{\circ}\text{C}$]	300	300
Safety temperature [$^{\circ}\text{C}$]	370	370
Temperature stability with E-sensor [$^{\circ}\text{C}$]	± 2	± 2
Total heating output [W]	1000	1500
External temperature sensor	Pt100	Pt100
PID parameter	1 set	1 set
Speed setting range [rpm]	150~1500	150~1500
Temperature and Speed display	LED display	LED display
Temperature and Speed setting	Turning knob	Turning knob
Time setting	1~9959min / continuous	1~9959min / continuous
Top plate material	Aluminium coated with ceramic	Aluminium coated with ceramic
Top plate dimensions [mm]	(160x155) x4	(150x133) x6
RS 232 interface	Yes	Yes
Dimensions W x D x H [mm]	405x320x80	525x320x87
Weight [kg]	8.5	9.0
Power supply	220V/50Hz	220V/50Hz

Infrared Hot Plate / Stirrer Attractive design for demanding heating & mixing

WH260-NH / WH260-H / WH260-R / WH260-RL

The WIGGENS new hotplate stirrer enjoys the benefits of Schott glass ceramic surface such as chemical resistance, a high surface quality, and a resistance to temperature shocks of more than 700°C, providing the users with optimal solution compared to conventional heating surface materials. The high infrared permeability ensures that the heating energy is transferred quickly and with very limited loss. i.e. it heats liquids fast and thus saves time and energy. PID control enables good temperature stability. If the Pt-100 sensor is connected, temperature-controlled work with stability of $\pm 2^\circ\text{C}$ can be reached in most applications.

All functions can be viewed and monitored on a large and clear LCD display, including most frequently used parameters like working temperature, stirring speed, working time, and safety temperature etc.

- > Memory function for stirring speed and temperature setting, convenient for experiments with fixed conditions.
- > Liquid drainage above the control board to prevent liquids from accessing the touching board and the electronics.
- > Direct connection for Pt100 temperature sensor for convenient solution temperature control.
- > Sealed outer shell and isolated critical parts design for enhanced longevity even in a harsh laboratory environment.
- > High safety protection: When exceeding the safety range of the hotplate (10-50 °C adjustable), the heating can be shut off immediately and automatically for the safety protection.
- > 3 sets of PID parameters, suitable for accurate control of small amount sample (small volume or specific heat), and quick heating and stable temperature of large volume sample.

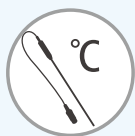

Standard PT100 temperature sensor

Accurate solution temperature within $\pm 2^\circ\text{C}$ in general range.



USB-A interface

Enable the unit to be connected to a PC for operating



LCD display

Simultaneously displaying various parameters, memory of the last working parameters.



Safety Temperature

is an adjustable temperature safety circuit that prevents from exceeding a specified set temperature. The safety temperature can be adjusted by using a special tool included in the product delivery



Ceramic glass top plate

Great anti-corrosive ability to acid, base, or organic solvents.



Ceramic Glass by Schott combines chemical resistance, top quality surfaces and resistance to temperature shocks of greater than 700°C.



Safety protection

Flashing high temperature indicator, warning for hurt by touch.

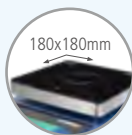

WH260-H / NH / AH

Plate dimension: 180x180mm



Liquid drainage

Above the control board
Avoid the solution splashing on the touch board.



WH260-R / AR

Plate dimension: $\varnothing 135\text{cm}$
Suitable for parallel application



Intelligent PID

Suitable for different application, for accurately controlling the quick heating of small sample and the stable temperature control of large sample.

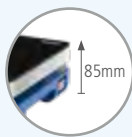

Height: Only 85mm



Overheating protection

If the internal temperature exceeds the permissible temperature that may damage the internal electronic components, the heating power will be reduced automatically.



Easy to operate thanks to rotating knobs control panel.

Strong & Robust



WH260-NH

In addition to speedy heating up and good temperature control, WH260-NH also offers well controlled liquids mixing from gentle to intense, being suitable for big volume viscous media as well.



WH260-R



WH260-NH



WH260-H



WH260-R

Specifications

Model	WH260-NH	WH260-H	WH260-R	WH260-RL
Order No.	W3012602	W3012603	W3012605	W3012606
Maximum temperature setting [°C]	450	450	450	450
Maximum temperature setting with E-sensor [°C]	300	300	300	300
Safety temperature [°C]	50~500 adjustable	50~500 adjustable	50~500 adjustable	50~500 adjustable
High temperature protection [°C]	10~50 adjustable	10~50 adjustable	10~50 adjustable	10~50 adjustable
Temperature stability with E-sensor [°C]	±2	±2	±2	±2
Heat output [W]	1000	800	800	800
External temperature sensor	Pt100	Pt100	Pt100	Pt100
PID parameter	3 sets	3 sets	3 sets	3 sets
Speed setting range [rpm]	100~1500	100~1500	100~1500	100~1500
Temperature and Speed display	LCD display	LCD display	LCD display	LCD display
Temperature and Speed setting	Turning knob	Turning knob	Turning knob	Turning knob
Time setting	1~1999min / continuous	1~1999min / continuous	1~1999min / continuous	1~1999min / continuous
Top plate material	Ceramic glass	Ceramic glass	Ceramic glass	Ceramic glass
Top plate dimensions [mm]	180×180	180×180	Ø135	Ø145
USB-A interface	Yes	Yes	Yes	Yes
Dimensions W x D x H [mm]	320X190X70	320X190X85	320X190X90	320X190X90
Weight [kg]	2.8	3.1	3.0	3.0
Power supply	220V/50Hz	220V/50Hz	220V/50Hz	220V/50Hz

Infrared Hot Plate / Stirrer

Intelligent heating technology for your very demanding applications

WH380 / WH385 UP to 1200W heating power

1.2kW



Standard PT100 temperature sensor
Accurate solution temperature within $\pm 2^{\circ}\text{C}$ in general range.



Extra large heating plate
Top plate dimensions: 280×280mm
Heating zone: $\varnothing 190\text{mm}$



Ceramic glass top plate
Great anti-corrosive ability to acid, base, or organic solvents.



Rapid heating up speed.
Temperature can reach up to 550°C , and one liter of water can be boiled in approx. 9 minutes
(Measured in 2L glass flask at 25°C ambient temperature and 1bar air pressure)



Touch controller (WH385)
with comfortable and easy operation



Heating power
With 1200W heating power, rapid heating speed.



Attractive designs for heating, stirring and controlling

WH380 presets 3 sets of PID for different volume heating application. WH385 uses advanced ICC technology to self-optimize for optimal results. WH380 has LCD display and WH385 has TFT

Model	WH380	WH385
Order No.	W3013803	W3013853
Maximum temperature setting [$^{\circ}\text{C}$]	550	550
Maximum temperature setting with E-sensor [$^{\circ}\text{C}$]	300	300
Safety temperature [$^{\circ}\text{C}$]	50~600 adjustable	50~600 adjustable
High temperature protection [$^{\circ}\text{C}$]	10~50 adjustable	10~50 adjustable
Temperature stability with E-sensor [$^{\circ}\text{C}$]	± 2	± 2
Heat output [W]	1200	1200
External temperature sensor	Pt100	Pt100
External reference temperature sensor	-	Thermocouple
PID parameter	3 sets	2 sets ICC
Speed setting range [rpm]	100~1500	100~1500
Temperature and Speed display	LCD display	TFT display
Temperature and Speed setting	Turning knob	Turning knob and touch screen
Time setting	1~1999min / continuous	00h01min00sec~99h59min00sec / continuous
Top plate material	Ceramic glass	Ceramic glass
Top plate dimensions [mm]	280×280	280×280
Heating zone [mm]	$\varnothing 190$	$\varnothing 190$
USB interface	Yes	Yes
Dimensions W x D x H [mm]	450X282X115	450X282X115
Weight [kg]	4.0	4.0
Power supply	220V/50Hz	220V/50Hz

Infrared Hot Plate / Stirrer

WH390 / WH395-NH / WH395 UP to 1800W heating power

Intelligent heating technology for powerful heating

1.8kW



Standard PT100 temperature sensor
Accurate solution temperature within $\pm 2^{\circ}\text{C}$ in general range.



Ceramic glass top plate
Great anti-corrosive ability to acid, base, or organic solvents.



Rapid heating up speed.
Temperature can reach up to 550°C , and one liter of water can be boiled in approx. 9 minutes
(Measured in 2L glass flask at 25°C ambient temperature and 1bar air pressure)



Intelligent PID (WH390)
Suitable for different application, for accurately controlling the quick heating of small samples and the temperature stability of large samples..



Intelligent Cascade Control (WH395)
self-optimizing, for optimal results.
Good temperature stability



Heating power
With 1800W heating power, rapid heating up speed.
2000W (WH390-NH)

WH390 presets 3 sets of PID for different volume heating application. WH395 uses advanced ICC technology to self-optimize for optimal results. WH390 has LCD display and WH395 has TFT



Specifications

Model	WH390	WH390-NH	NEW WH395
Order No.	W3013902	W3013903	W3013953
Maximum temperature setting [$^{\circ}\text{C}$]	650	450	650
Maximum temperature setting with E-sensor [$^{\circ}\text{C}$]	300	300	300
Safety temperature [$^{\circ}\text{C}$]	50~700 adjustable	50~500 adjustable	50~700 adjustable
High temperature protection [$^{\circ}\text{C}$]	10~50 adjustable	10~50 adjustable	10~50 adjustable
Temperature stability with E-sensor [$^{\circ}\text{C}$]	± 2	± 2	± 2
Heat output [W]	1800	2000	1800
External temperature sensor	Pt100	Pt100	Pt100
External reference temperature sensor	-	-	Thermocouple
PID parameter	3 sets	3 sets	2 sets (Oil / Water)
Speed setting range [rpm]	100~1500	100~1500	100~1500
Temperature and Speed display	LCD display	TFT display	TFT display
Temperature and Speed setting	Turning knob	Turning knob	Turning knob and touch screen
Time setting	1~1999min / continuous	1~1999min / continuous	00h01min00sec~99h59min00sec / continuous
Top plate material	Ceramic glass	Ceramic glass	Ceramic glass
Top plate dimensions [mm]	280×280	280×280	280×280
Heating zone [mm]	$\varnothing 190$	$\varnothing 190$	$\varnothing 190$
USB interface	Yes	Yes	Yes
Dimensions W x D x H [mm]	450X290X120	450X290X100	450X290X120
Weight [kg]	4.1	4.1	4.1
Power supply	220V/50Hz	220V/50Hz	220V/50Hz

Soft Dry Bath -one for all shapes of vessels

Heating in reflux, distillation and rectification, Oil free heating, completely new experience

WIGGENS launched one for all shapes of vessels Soft Dry Bath which can be easily mounted on the top of 135mm round hotplate top.

- > The high quality soft dry bath developed and produced by Wiggins have uniform heat transfer and fast heat conduction, which is very suitable for replacing the small oil bath commonly used in the laboratory dry bath module, electric heating sleeve and other heating methods.
- > Aluminum bottom of the bath, helps to transfer the heat to alloy particles very fast. It is surrounded by PTFE material, for insulation and anticorrosion
- > With infrared heating (IR) technology and ICC self-tuning temperature control technology of Wiggins, it can achieve faster heating effect and better temperature stability.

- Suitable for containers of any shape
- Replacement of Silicon oil
- Replacement of thermostat module
- High temperature
- Safety
- New experience
- No cleaning required
- Energy conservation and environmental protection
- The exclusive technology



One For All



Suitable for containers of any shape

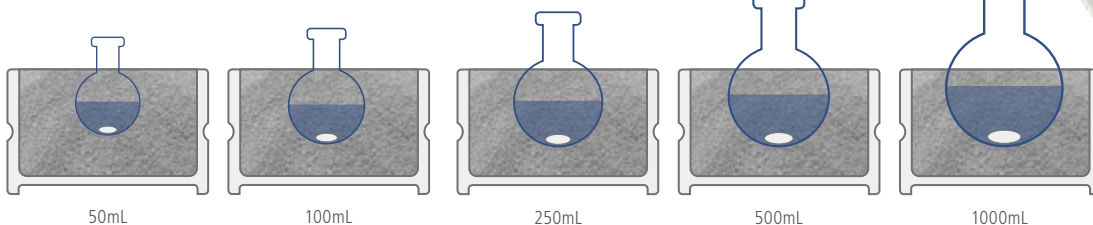

Suitable for containers of different volumes

Order information

Order No.	Model	Description
SDB-1	Dry bath tank and jacket	The dry bath tank and PTFE insulation jacket internal diameter: 140mm
SDB-2	Alloy seeds	The alloy seeds, 2kg

* For digital hot plate / stirrers (WH260-R or WH280-R), you need to order separately.



For stirrer bars, please reference Page 89

Accessories for Hot Plate / Stirrer

Thermometer

Order No.	Description
PR5500	Temperature resolution: 1°C or 0.1°C Standard package with two sensors: Pt100 (250×Ø4mm), temperature range: -50.0~ 400.0°C ; Type K thermocouple (170×Ø4mm, temperature range: -50.0~ 500.0°C
PR5600	Temperature resolution: 0.01°C or 0.001°C Standard with two sensors: Pt100 (250×Ø4mm), temperature range: -50.0~ 400.0°C ; Type K thermocouple (170×Ø4mm, temperature range: -50.0~ 500.0°C
Order No.	Description
PR5000-1	Pt100 (250×Ø4mm), temperature range: -50.0~ 400.0°C ;
PR5000-2	Type K thermocouple (170×Ø4mm, temperature range: -50.0~ 500.0°C



Temperature sensor

Order No.	Description
PT100-01	PT100, Type I; -30~300°C ;Length: 170 mm; Diameter: 4 mm; Material: Stainless steel;
PT100-02	PT100, Type II; -30~300°C ; Length: 300 mm; Material: Stainless steel, Fig. ⑥
PT100-03	PT100, Type III; -30~250°C ; Length: 170 mm; Material: Stainless steel, PTFE coated, Fig. ⑦
PT100-04	PT100, Type IV; -30~250°C ;Length: 300 mm; Material: Stainless steel, PTFE coated
PT100-06	PT100, Type VI; -30~300°C ; Length: 250 mm; Diameter: 4 mm; Material: Glass; Fig. ⑧
600.170.1	K type thermocouple 0-500°C ; Length: 170 mm; Diameter: 4 mm; Material: Stainless steel;

Holder for temperature sensor

Order No.	Description
PT100-05	Holder and clamp for PT100 temperature sensor, Fixed temperature sensor PT100-05: ①②③④⑤
WH220017	① Installation stand, M8x10x400mm
WH220026	② Boss head clamp, Aluminum
WH220027	③ Sensor holder, POM
WH220095	④ Holding rod, M8x8x200mm
WH220096	⑤ Clamp screws, M6x22x15mm



Clamps for oil bath

Order No.	Description
WA00-56A	fast and easy to fix the big volume flask. It's adjustable according to the size of the container



Glass oil bath

Order No.	Model	Description
		with spout
213115407	G1000	Oil bath, Glass, 900mL, inner Ø 140 mm, 75 mm height (SCHOTT)
213115904	G2000	Oil bath, Glass, 2L, inner Ø 190 mm, 90 mm height (SCHOTT)
213116309	G3500	Oil bath, Glass, 3.5L, inner Ø 230 mm, 100 mm height (SCHOTT)

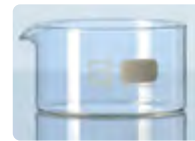

Stainless steel oil bath

for WH260-R, WH280-R, Ø 135mm

Order No.	Model	Description
H220000	H1000	Beaker, stainless steel, 1.9 l, inner Ø 177 mm, 83 mm height



Cylindrical heating block

Order No.	Description	For
13696-01W	Stainless T-shape handle, length: 20cm	All types of heating block
13696-02W	Stainless T-shape handle, length: 30cm	All types of heating block
13697-01W	28×30 (ID x H in mm) 11 Holes	WH260-R
13697-02W	28×50 (ID x H in mm) 11 Holes	WH260-R
13697-03W	26×30 (ID x H in mm) 11 Holes	WH260-R
13697-04W	28×30 (ID x H in mm) 11 Holes	WH260-R
13697-11W	28×30 (ID x H in mm) 15 Holes	WH260-R
13697-12W	28×50 (ID x H in mm) 15 Holes	WH260-R
13697-13W	26×30 (ID x H in mm) 15 Holes	WH260-R
13697-14W	26×50 (ID x H in mm) 15 Holes	WH260-R
13699-04W	60.3mm Diameter, 4 holes	WH260-R
13699-03F	69 mm Diameter, 3 Holes	WH260-R
13699-05W	48.5 mm Diameter, 5 Holes	WH260-R
13699-150	62.2mm Diameter, 4 Holes	WH260-R
13699-01W	100mL Beakers, 3 Holes	WH260-R
13699-02W	62.2 mm Diameter, 3 Holes	WH260-R
13707-250	250mL Beakers Form	WH260-R
13707-500	500mL Beakers Form	WH260-R
13707-1000	1000mL Beakers Form	WH260-R
13707-2000	2000mL Beakers Form	WH260-R

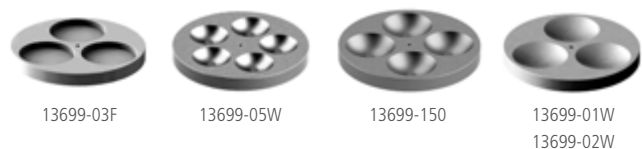
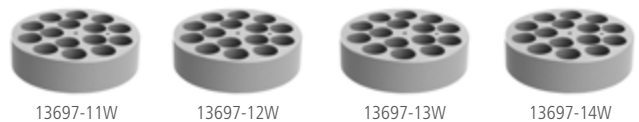
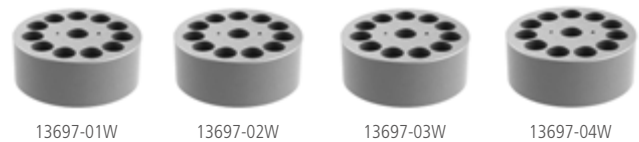

Magnetic Stirrer

- > LED display for convenient control and monitoring of the stirring speed
- > Leading microprocessor control technology ensures accuracy and stability of the stirring speed
- > Stirring plate surface made of powder coated stainless steel
- > Wide speed range between 150 and 1500 rpm
- > Individual control for each plate

Best-seller!



Specifications

Model	WH-210D	WH-410D	WH-610D
Order No.	400214	400215	400216
Number of stirring positions	1	4	6
Stirring quantity max. per stirring position (H ₂ O) [L]	3	2	2
Speed setting range [rpm]	150~1500	150~1500	150~1500
Speed display	LED display	LED display	LCD display
Speed setting	Turning knob	Turning knob	Turning knob
Top plate material	Powder coated stainless steel	Powder coated stainless steel	Powder coated stainless steel
Top plate dimensions [mm]	158 x143	(151 x156) x4	(151 x156) x6
Dimensions W x D x H [mm]	189 x215 x48	344 x377 x48	504 x377 x48
Weight [kg]	1.8	2.5	4.0
Power supply	220V/50Hz	220V/50Hz	220V/50Hz

Corrosion resistant mat for Magnetic Stirrer

- > Corrosion resistant and protect the surface of magnetic stirrer
- > The surface is non-slippery, with adhesive layer on the back, which is easy to fix.
- > Repeatedly for use and can be replaced

Order No.	400214-PTFE	400215-PTFE	400216-PTFE
Suitable for	WH-210D	WH-410D	WH-610D
Material	PTFE	PTFE	PTFE
Thickness	0.18mm	0.18mm	0.18mm
Attachment strength	25N/100mm	25N/100mm	25N/100mm
Tensile strength	400/100mm	400/100mm	400/100mm
Temperature range	70~260°C	70~260°C	70~260°C
Size	158mmx170mm	317mmx325mm	317mmx485mm

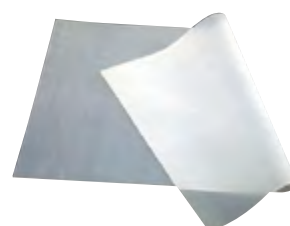

Submersible Magnetic Stirrer

Fully encapsulated and hermetically sealed housing, and suitable for the use in incubators and ovens. water-, dust-, and germ proof, submersible in water.

Stirrer Model	S-1	B-1
Order No. of Stirrer	400214	400215
Number of stirring positions	1	1
Stirring quantity max. per stirring position (H2O) [L]	1	3
Top plate material	PP housing	PP housing
Dimensions W x H x D [mm]	70 x70 x28	155 x155 x45
Power supply	The power supplied by remote controller	



Order No.	Description
S-1-01	Connection adapter to fix several stirrers together as one multi-position stirrer, Suitable for S-1
B-1-01	Connection adapter to fix stirrers together as one multi-position stirrer, Suitable for B-1



Working inside with the thermostatic bath



Same speed for all connected stirrers
CS-1 and CB-1 controller



Different speed for connected stirrers
CS-4 and CB-4 controller

Controller for submersible magnetic stirrers

Controller Model	CS-1	CS-4	CB-1	CB-4
Suitable for	S-1	S-1	B-1	B-1
Working mode	Same speed for all connected stirrers	Different speed for connected stirrers	Same speed for all connected stirrers	Different speed for connected stirrers
Maximum number of stirrer to connect	4	4	4	4
Speed setting range [rpm]	100~1500	100~1500	100~1500	100~1500
Speed setting	Turning knob	Turning knob	Turning knob	Turning knob
Power supply	220V/50Hz	220V/50Hz	220V/50Hz	220V/50Hz

Cylindrical Stirrer Bars

Cylindrical Stirrer Bars have a smooth round profile. A popular general purpose stirrer for a wide variety of applications.



Glass Covered Stirrer Bars

For use with very abrasive media which may erode PTFE

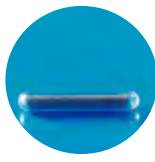

Plain Stirrer Bars

Plain Stirrer Bars have similar functions as the cylindrical but give more turbulence at low speed.



Octahedral Stirrer Bars

Octahedral Stirrer Bars use have similar functions as Pivot Ring type but with increased turbulence at low speeds.



Oval Stirrer Bars

Oval Stirrer Bars are for round bottom flasks.



Cross Stirrer Bars

Cross Stirrer Bars are very stable general purpose stirrers.



Double Ended Stirrer Bars

Double Ended Stirrer Bars have a double paddle action for efficient stirring plus high stability.



Tube Stirrer Bars

Tube Stirrer Bars are designed for use with 10mm standard cuvettes.



Colored Octahedral Stirrer Bars

Colored Octahedral Stirrer Bars are for use where identification is of prime importance.



Micro Stirrer Bars

Micro Stirrer Bars are for the smallest containers. Note: Always use the largest stirrer bar possible.



Turbo cylindrical

Exceptional strength coupled with almost total resistance to demagnetisation. Identified by an inert carbon black spot.



Stirrer Bars

Order No.	Name	Description
1.110.6	Cylindrical Stir Bar	Length:10mm,Diameter:6mm
1.115.6	Cylindrical Stir Bar	Length:15mm,Diameter:6mm
1.120.7	Cylindrical Stir Bar	Length: 20mm, Diameter: 7mm
1.120.8	Cylindrical Stir Bar	Length:20mm,Diameter:8mm
1.125.8	Cylindrical Stir Bar	Length: 25mm, Diameter: 8mm
1.130.8	Cylindrical Stir Bar	Length:30mm,Diameter:8mm
1.140	Cylindrical Stir Bar	Length:40mm,Diameter:8mm
1.145	Cylindrical Stir Bar	Length:45mm,Diameter:8mm
1.150	Cylindrical Stir Bar	Length:50mm,Diameter:8mm
1.180	Cylindrical Stir Bar	Length:80mm,Diameter:10mm
1.1212	Glass Covered Stir Bar	Length: 12mm, Diameter: 5mm
1.1225	Glass Covered Stir Bar	Length: 25mm, Diameter: 6mm
1.1245	Glass Covered Stir Bar	Length: 45mm, Diameter: 8mm
1.1260	Glass Covered Stir Bar	Length: 60mm, Diameter: 8mm
1.215.6	Plain Stir Bar	Length: 15mm, Diameter: 6mm
1.220.7	Plain Stir Bar	Length: 20mm, Diameter: 7mm
1.230.7	Plain Stir Bar	Length: 30mm, Diameter: 7mm
1.240	Plain Stir Bar	Length: 40mm, Diameter: 8mm
1.250	Plain Stir Bar	Length: 50mm, Diameter: 8mm
1.260	Plain Stir Bar	Length: 60mm, Diameter: 10mm
1.270	Plain Stir Bar	Length: 70mm, Diameter: 10mm
1.280	Plain Stir Bar	Length: 80mm, Diameter: 10mm
1.515	Octahedral Stir Bar	Length: 15mm, Diameter: 8mm
1.525	Octahedral Stir Bar	Length: 25mm, Diameter: 8mm
1.538.10	Octahedral Stir Bar	Length: 38mm, Diameter: 10mm
1.551.10	Octahedral Stir Bar	Length: 51mm, Diameter: 10mm
1.575.10	Octahedral Stir Bar	Length: 75mm, Diameter: 13mm
1.620	Oval Stir Bar	Length: 20mm, Diameter: 10mm
1.625.10	Oval Stir Bar	Length: 25mm, Diameter: 10mm
1.630	Oval Stir Bar	Length: 30mm, Diameter: 16mm
1.635	Oval Stir Bar	Length: 35mm, Diameter: 16mm
1.640	Oval Stir Bar	Length: 40mm, Diameter: 20mm
1.650.17	Oval Stir Bar	Length: 50mm, Diameter: 17mm
1.650	Oval Stir Bar	Length: 50mm, Diameter: 20mm
1.2402	Cross-Shaped Stir Bar	Length: 20mm, Diameter: 8mm
1.2405	Cross-Shaped Stir Bar	Length: 38mm, Diameter: 11mm
1.2407	Cross-Shaped Stir Bar	Length: 60mm, Diameter: 20mm
1.1335	Double Ended Stir Bar	Length: 35mm, Diameter: 8mm
1.1355	Double Ended Stir Bar	Length: 55mm, Diameter: 8mm
1.1335-R/B/Y	Double Ended Stir Bar	Length: 35mm, Diameter: 8mm
1.1355-R/B/Y	Double Ended Stir Bar	Length: 55mm, Diameter: 8mm
1.420	Triangular Stir Bar	Length: 20mm, Diameter: 8mm
1.440	Triangular Stir Bar	Length: 40mm, Diameter: 14mm
1.450	Triangular Stir Bar	Length: 50mm, Diameter: 12mm
1.480	Triangular Stir Bar	Length: 80mm, Diameter: 14mm
1.4136	Triangular Stir Bar	Length: 136mm, Diameter: 36mm
1.1609	Tube Stir Bar	Length: 6mm, Diameter: 9mm
1.515-R,B/Y	Colored Octahedral Stir Bar	Length: 15mm, Diameter: 8mm
1.525-R,B/Y	Colored Octahedral Stir Bar	Length: 25mm, Diameter: 8mm
1.538-R,B/Y	Colored Octahedral Stir Bar	Length: 38mm, Diameter: 8mm
1.551.-R,B/Y	Colored Octahedral Stir Bar	Length: 51mm, Diameter: 8mm
1.575-R,B/Y	Colored Octahedral Stir Bar	Length: 75mm, Diameter: 13mm
1.802	Micro Stir Bar	Length: 2mm, Diameter: 2mm
1.806	Micro Stir Bar	Length: 6mm, Diameter: 3mm
1.808	Micro Stir Bar	Length: 8mm, Diameter: 1.5mm
1.813	Micro Stir Bar	Length: 13mm, Diameter: 3mm
001-350-8	Turbo Stir Bar	Length 35mm, Diameter: 8mm
1.160.RE	Turbo cylindrical	Length: 60mm, Diameter: 10mm

The first address for laboratory hotplates

Infrared Hot Plate

- > Smooth and corrosion resistant ceramic glass top plate
- > Excellent transmittance of the infrared light
- > Material can resist a thermal shock of up to 700°C
- > Corrosion-resistant, solid casing which is hermetically sealed
- > Fast heating and excellent temperature stability
- > Temperature can be externally controlled by the connection of a Pt100 temperature sensor
- > Large LCD screen displays the set and actual temperature
- > A high-temperature indicator warns the user and prevents burning injuries
- > Compressed air connector optionally available for the use of the hotplate in an aggressive environment
- > Rod holder can be conveniently used to connect diverse accessories such as a temperature sensor
- > Can be connected to an external temperature sensor for direct and precise temperature control



SLK2-T heating up 1L water up to 80°C with external control mode in 15min

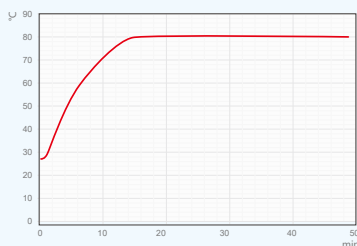

SLK2-T heating up 1L oil up to 160°C with external control mode in 18min

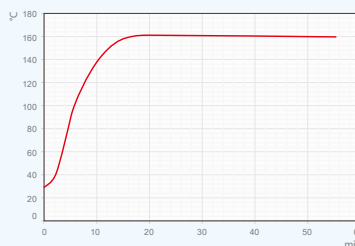

Note: Above data is based on the 220V/50Hz instrument with pure water (H₂O) and simethicone (Silicon Oil).

SLK1-T / SLK2-T



Pt-100 sensor is not included in the standard delivery
For external temperature sensor
Please refer to Page 85

Specifications

Model	SLK1-T	SLK2-T
Order No.	W3032391	W3032392
Maximum temperature setting	650 [°C] / 24 steps	650 [°C] / 24 steps
Maximum temperature setting with E-sensor [°C]	300	300
Safety temperature [°C]	50~700 adjustable	50~700 adjustable
High temperature protection [°C]	10~50 adjustable	10~50 adjustable
Temperature stability with E-sensor [°C]	±2	±2
Heat output [W]	1200	1800
External temperature sensor	Pt100	Pt100
PID parameter	3 sets	3 sets
Temperature and Speed display	LCD display	LCD display
Temperature and Speed setting	Turning knob	Turning knob
Time setting	1~1999min / continuous	1~1999min / continuous
Top plate material	Ceramic glass	Ceramic glass
Top plate dimensions [mm]	280×280	280×280
Heating zone [mm]	Ø190	Ø190
USB interface	Yes	Yes
Dimensions W x D x H [mm]	450X290X120	450X290X120
Weight [kg]	4.1	4.1
Power supply	220V/50Hz	220V/50Hz

Digital Hot Plate

- > PID temperature control technology for accurate and reliable results
- > Suitable for complicated temperature control requirements
- > Bright LED screen can display both set value and actual temperature
- > Convenient temperature setting via on-touch control
- > Timer function for automatic heating up to 100 hours
- > Alarm signal output which can be applied to stop the operation of the hot plate and other connected devices
- > External Pt100 temperature sensor connection for direct and precise control of the actual sample temperature

The data for H200D-2K heating up the high-temperature oil from 50 to 150°C (with external temperature sensor)

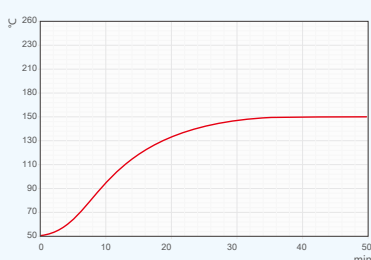

The surface temperature stability data for WH200D-2K (250°C)

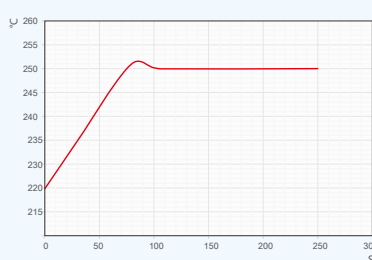

Note: Above data is based on the 220V/50Hz instrument with pure water (H₂O) and simethicone (Silicon Oil).



For external temperature sensor
Please refer to Page 85



WH200D-1K



WH200D-2K

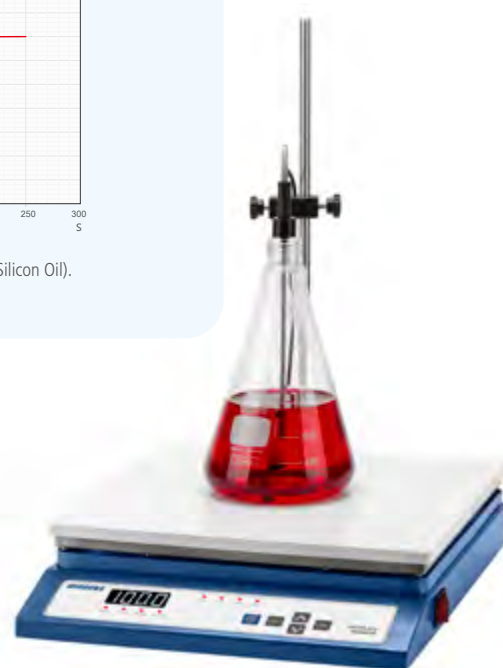

WH200D-3K

Specifications

Model	WH200D-1K	WH200D-2K	WH200D-3K
Order No.	400110	400111	400112
Maximum temperature setting	300	300	300
Maximum temperature setting with E-sensor [°C]	300	300	300
Temperature stability [°C]	±2	±2	±2
Heat output [W]	680	1000	1500
External temperature sensor	Pt100	Pt100	Pt100
Temperature display	LED display	LED display	LED display
Temperature setting	Turning knob	Turning knob	Turning knob
Top plate material	Aluminum coated with ceramic	Aluminum coated with ceramic	Aluminum coated with ceramic
Top plate dimensions [mm]	170×170	320×320	400×300
Dimensions W x D x H [mm]	240 x280 x70	320 x360 x70	470 x410 x70
Weight [kg]	2.5	7.5	9.0
Power supply	220V/50Hz	220V/50Hz	220V/50Hz

Multi-Purpose Heater / Dry Bath

Microprocessor control

The built-in unique microprocessor can provide precise temperature control for a variety of biochemical experiments.

Heating chamber in one piece

The heating tank is made of molded aluminum bath coated with PTFE

Various optional heating blocks

Various types of heating block are available for option, and customized block is optional.

Three types of timer modes

OFF, OFF-TIME, and WAIT-TIME

Certification

CE certification

Applications

- > Molecular biology
- > Biochemistry

Precise temperature control!

- > Rapid heat up speed
- > Exceptional temperature uniformity
- > External PT 100 temperature sensor included

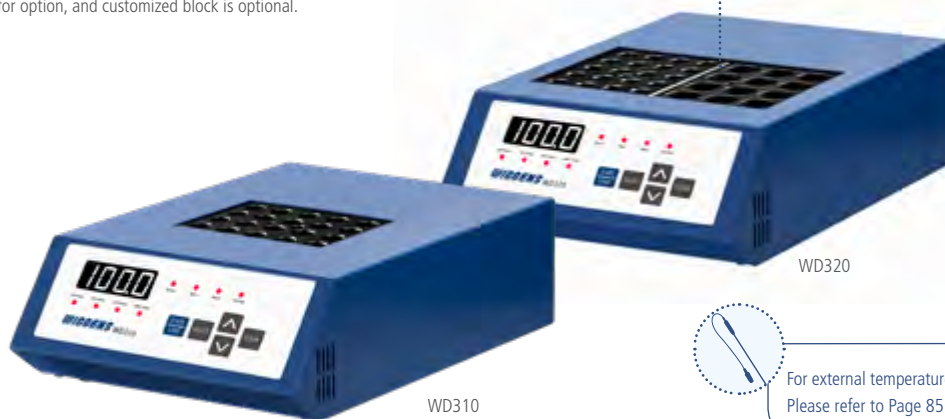

For external temperature sensor
Please refer to Page 85

WIGGENS® dry block heaters are highly versatile suitable for broad range of applications.

- > DNA extractions
- > DNA analysis
- > Melting point determination
- > Nucleic acid hybridization
- > Coagulation studies
- > Biochemical processes
- > Incubation and activation of cultures
- > Blood examinations
- > Fertile ground processing
- > Restriction digest
- > Denaturation
- > Boiling point determination
- > Enzymatic processes
- > Enzyme activity studies
- > Blood-urea-nitrogen determinations
- > Immunoassays
- > Enzyme reactions
- > In situ hybridization

Specifications

Model	WD310	WD320
Order No.	179310	179320
Temperature setting range [°C]	50.0~150.0	50.0~150.0
Temperature setting range with E-sensor [°C]	40.0~150.0	40.0~150.0
Safety temperature [°C]	Cut off at 170.0	Cut off at 170.0
Temperature stability [°C]	±0.1	±0.1
Temperature accuracy [°C]	±0.1	±0.1
Time setting [min]	1~9959 / off	1~9959 / off
External temperature sensor	Pt100	Pt100
Temperature display	LED display	LED display
Temperature setting	Touch button	Touch button
Number of heating blocks × (block size W×L×Hmm)	1×(79×104×50)	2×(79×104×50)
Dimensions W x D x H [mm]	200 x270 x80	200 x270 x80
Weight [kg]	2.6 (W/O the block)	2.8 (W/O the block)
Power supply	220V/50Hz,1A	220V/50Hz,2A

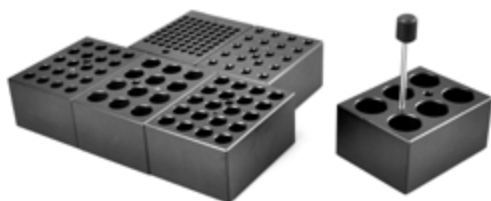

Heating Blocks for WD310 and WD320

Order No.	Size	Number of Holes	Ø x H (mm)
179300-01	0.2mL	64	6x17mm
179300-02	0.5mL	20	8x25mm
179300-03	1.5mL(or2.0)	20	11x35mm
179300-04	10mL	20	10x33mm
179300-05	13mL	20	13x36mm
179300-06	20mL	12	20x48mm
179300-07	25mL	6	25x45mm
179300-10	17mL	12	17x44mm

COD Reactor

Features

Compliance with regulations

WD325 COD reactor is used to digest closed micro reflux COD vial and can meet USEPA 410. 4. It is easier and safer than traditional open macro reflux method.

Special COD program

Just press start/stop button, and the reactor will start to heat up to 150°C and keep for 2-hour countdown then shut down automatically with 10-sec audio alarm.

3 additional program settings

Temperature range setting 60°C - 200°C and timer from 1 - 999. 3 Built-in additional heating program settings available for users to store and execute as needed.

Auto shut off and audio alarm

WD325 can stop heating, and then shut off automatically with audio alarm when every program is completed.

Applications

- > Waste water from factories
- > Water quality in lake, pond and river



For external temperature sensor
Please refer to Page 85



Specifications

Model	WD325
Order No.	179200
Temperature setting range [°C]	Fixed 150.0°C for COD, 60.0~200.0 adjustable
Temperature accuracy [°C]	±2 (at 150.0°C)
Hot top indicator	Flashing when block temperature is over 70.0°C
Automatic shutoff	The temperature of block is over 240.0°C
Time setting [min]	1~1999 with audible alarm and automatic shutoff or continuous operation
Heat output [W]	220
Temperature display	LED display
Temperature setting	Touch button
Number of heating blocks × (block size W×L×Hmm)	25×(Ø16.5*55mm sample vials)
Optional block is available.	
Housing material	Stainless steel with powder paint coating
Heating block material	Aluminium alloy
Dimensions W x D x H [mm]	189 x315x116
Weight [kg]	4.5
Power supply	110V/60Hz or 220V/50Hz

Heating & Cooling Block

Rapid cooling and heating in centrifuge tubes, sample vials, micro tubes within the broad temperature range of 4 to 95°C . Outstanding temperature compensation function guarantees precise temperature control.

Features

- > Precision accuracy of $\pm 0.1^{\circ}\text{C}$ is ensured by its PID controller.
- > Wide temperature control range from 4 to 95°C with rapid cool down and heat-up times.
- > Maximum 9 temperature range-specific calibration.
- > Memory function of programmed protocols allowing relevant parameters of each protocol step to be stored.
 - Up to 10 protocols allowed for memory storage.
 - Up to 10 steps allowed for each protocol.
- > Two types of timer modes:
 - Timer 1 starts only after reaching the set temp.
 - Timer 2 starts right after the timer setting.

Convenience

- > Cooling is controlled by Peltier elements for an energy efficient compact design.
- > Bright VFD display with responsive touch buttons.
- > Its polypropylene main body is highly chemical-resistant and easy-to-clean.
- > Optimal heat transfer is achieved by the tight coupling design of the main body and the corrosion-resistant anodized aluminum blocks.
- > Transparent lid allows easy sample monitoring and even temperature distribution.
- > Blocks can be easily interchanged by the included block lifter.



Specifications

Model	WB-350	
Order No.	W3033350	
Control system	Feedback control PID	
Display	VFD(0.1°C resolution)	
Temperature	Range (°C)	4 to 95
	Fluctuation at 37°C ($\pm^{\circ}\text{C}$)	0.1
	Variation at 37°C ($\pm^{\circ}\text{C}$)	0.5
Safety	Over temp.	Heating plate
	Over current	PCB
		Current limit protection
Dimension (W×D×H)	Interior (mm)	99 x 77.5 x 36
	Exterior (mm)	249×330×168
	Net weight (kg)	5.0
Electrical requirements	230V, 50 / 60Hz/2A	

Permissible environmental conditions: temperature (2-60°C) and relative humidity (up to 80%)

Multi-Purpose Heater / Dry Bath

Ideal for simultaneous sample heating of multiple vials or test tubes with uniform and precise temperature control.

Features

- > Precision accuracy of $\pm 0.1^{\circ}\text{C}$ is ensured by its PID controller from ambient + 5°C to 130°C .
- > Its built-in temperature limit setting feature (with max. 0.2°C overshooting) allows you to perform highly temp. sensitive reactions such as isothermal amplifications.
- > Automatic power cutoff.
 - If the temperature of the main body exceeds 150°C .
 - If the internal circuit is overheated.
- > Two types of timer modes:
 - Timer 1 starts only after reaching the set temp.
 - Timer 2 starts right after the timer setting.

Convenience













- > Its polypropylene main body is highly chemical-resistant and easy-to-clean.
- > Optimal heat transfer is achieved by the tight coupling design of the main body and the corrosion-resistant anodized aluminum blocks.
- > Bright VFD display with responsive touch buttons.
- > Transparent lid allows easy sample monitoring and even temperature distribution.
- > Blocks can be easily interchanged by the included block lifter.



Specifications

Model		WB-350T	WB-350S
Order No.		W3033351	W3033352
Control system		Feedback control PID	Feedback control PID
Display		VFD (0.1°C resolution)	VFD (0.1°C resolution)
Temperature	Range (°C)	Amb. +5 to 130	Amb. +5 to 130
	Fluctuation at 37°C ($\pm^{\circ}\text{C}$)	0.1	0.1
	Variation at 37°C ($\pm^{\circ}\text{C}$)	0.5	0.5
Safety	Over temp.	Heating plate	Heating plate
		PCB	PCB
	Over current	Current limit protection	Current limit protection
Dimension (W×D×H)	Interior (mm)	154×99×37	154×99×37
	Exterior (mm)	249×330×250	249×330×125
	Net weight (kg)	4.3	3.9
Electrical requirements		230V, 50 / 60Hz/2.8A	230V, 50 / 60Hz/2.8A

Tube Blocks

Block	Order No.	Description	WxDxH (mm)	Mountable Capacity of Blocks		
				WB-350S	WB-350T	WB-350
	W3033001	0.2mL x 96 holes (microtube)	153×98×41	1	1	-
	W3033002	0.5mL x 48 holes (microtube)	98×76.5×41	2	2	1
	W3033003	1.5mL x 48 holes (microtube)	153×98×41	1	1	-
	W3033004	15mL x 15 holes (centrifuge tube)	98×76.5×51	2*	2	1*
	W3033005	50mL x 6 holes (centrifuge tube)	98×76.5×51	2*	2	1*
	W3033006	50mL x 6 holes (centrifuge tube)	98×76.5×87	2	2	1*
	W3033007	Ø10 x 35 holes	98×76.5×51	2*	2	1*
	W3033008	Ø12 x 24 holes	98×76.5×51	2*	2	1*
	W3033009	Ø13 x 24 holes	98×76.5×51	2*	2	1*
	W3033010	Ø15 x 20 holes	98×76.5×51	2*	2	1*
	W3033011	Ø16 x 16 holes	98×76.5×51	2*	2	1*
	W3033012	Ø18 x 12 holes	98×76.5×51	2*	2	1*
	W3033013	Ø20 x 12 holes	98×76.5×51	2*	2	1*

* Available to use only when the lid is opened.

Soxhlet Extraction System (SES)

Wiggins Soxhlet Extraction System is based on the Soxhlet extraction principle and integrates such functions as soaking, extraction, leaching, heating, condensation and solvent recovery. It features sealed metal bath heating with automatic temperature control, ensuring uniform heating and safe operation; six samples can be tested at the same time, and optimal temperature can be selected according to the difference between reagent boiling point and RT. so as to achieve quick analysis; reagents can also be recycled to reduce test cost; and soaking, extraction and solvent recovery can be done in one step. Therefore, this device is characterized by reasonable design, stable performance, good reproducibility, high accuracy, easy operation, saving time and effort, and so on.

SES can quickly separate one substance from solid or semi-solid mixtures, can determine the soluble organic compounds contained in foods, feeds, medicines, soil, sludge, polymers, fiber products, petrochemical products, detergent, rubbers, plastics and other materials.



LED display

The set temperature and actual temperature can be displayed simultaneously



450°C

Extremely high temperature

Temperature can reach up to 450°C
Display resolution is 0.1



Independent temperature control

According to the experimental requirements, different position can be run at the same or different temperature



Glassware

Both round and flat bottom flasks can be ordered with 300ml and 500ml volume



Cellulose fiber extraction thimbles

Optional, good retention. seamless, high quality extraction thimbles, single thickness.
Readily permeable to the flow of ether and other organic solvents.



Specifications

Order No.	Model	Temperature range	Heat output	Flask volume		Glass extraction thimbles	
		°C	Each position [W]	volume [ml]	Bottom	ID x H [mm]	Sintered glass
3-place Soxhlet Extraction System (Multi-position heating mantle with stand)							
W3030350	SES350	Rt. +5~450	180W	500	Flat	45 x 130	20-35um / 100-200 um
W3030355	SES355	Rt. +5~450	180W	500	Round	45 x 130	20-35um / 100-200 um
W3030395	SES395	Rt. +5~450	290W	1000	Round	45 x 130	20-35um / 100-200 um
6-place Soxhlet Extraction System (Multi-position heating mantle with stand)							
W3030630	SES630	Rt. +5~450	125W	300	Flat	45 x 130	20-35um / 100-200 um
W3030635	SES635	Rt. +5~450	125W	300	Round	45 x 130	20-35um / 100-200 um

Glassware need to be ordered separately

Multi-Position Heating Mantle

WIGGENS Multi-position heating mantle has always been the mantle of choice for repetitive extracting, refluxing, and distilling procedures in labs of the food, textile fiber, water and waste-water, petroleum, and many other industries. WIGGENS latest version offers safety and convenience never before available in a multi-place heating mantle.

- > Lower profile for space-saving convenience
- > Revolutionary heating element container system makes replacing burned-out elements a simple task
- > Clear anodized aluminum cabinet with blue PTFE resin coated top for chemical resistance.
- > Offered in two space-saving configurations; six-place for 100 - 300 mL flasks and three-place for 500 - 1,000 mL flasks
- > Available in low-temperature (450°C RX version) and high-temperature (650°C RJ version) for greater versatility
- > The ideal mantle for Kjeldahl, Soxhlet, and other extraction procedures.



LED display

The set temperature and actual temperature can be displayed at the same time



Extremely high temperature

Temperature can reach up to 450°C
Display resolution is 0.1



Extremely high temperature

Temperature can reach up to 650°C
Display resolution is 0.1



Independent temperature control

According to the experimental requirements, each position can be set at the same or different temperature



Replaceable element containers

The replaceable element containers provide spill containment and can be replaced in a matter of a few minutes.

Order No.	Model	Flask Size ml	Maximum Diameter mm	Bottom	Rating Per Position	Replacement Element Order No.
450°C Three-Place - medium temperature						
W3031350	RX350	500	103	Flat	180W	RX50024E
W3031354	RX354	500	101	Round	180W	RX50224E
W3031394	RX394	1000	130	Round	290W	RX100024E
650°C Three-Place - high temperature						
W3031356	RJ356	500	103	Flat	300W	RJ50024E
W3031358	RJ358	500	101	Round	300W	RJ50224E
450°C Six-Place - medium temperature						
W3031630	RX630	250/300	87	Flat	125W	RX30024E
W3031634	RX634	250/300	87	Round	125W	RX30424E
650°C Six-Place - high temperature						
W3031636	RJ636	250/300	87	Flat	210W	RJ30024E
W3031638	RJ638	250/300	87	Round	210W	RJ30424E



Table C - Soxhlet Lipid Extraction Apparatus (for Combo Mantles)

Size	Flask volume (mL)	Extractor Top Joint	Extractor Bottom Joint	Package Order No.	Condenser Order No.	Extractor Order No.	Extraction Thimbles Order No.	Flask volume Order No.
Suitable for Wiggins Combo Mantles (Six positions Flat Bottom)								
A	100	34 / 45	24 / 40	189100-11	189102-01	189101-01	189103-01	189105-01
A	100	34 / 45	24 / 40	189100-12	189102-01	189101-01	189103-02	189105-01
A	125	34 / 45	24 / 40	189100-01	189102-01	189101-01	189103-01	189105-02
A	125	34 / 45	24 / 40	189100-02	189102-01	189101-01	189103-02	189105-02
B	250	45 / 50	24 / 40	189100-03	189102-02	189101-02	189103-03	189105-03
B	250	45 / 50	24 / 40	189100-04	189102-02	189101-02	189103-04	189105-03
D	300	55 / 50	24 / 40	189100-05	189102-03	189101-04	189103-05	189105-04
D	300	55 / 50	24 / 40	189100-06	189102-03	189101-04	189103-06	189105-04
Suitable for Wiggins Combo Mantles (Six positions Round Bottom)								
A	100	34 / 45	24 / 40	189100-21	189102-01	189101-01	189103-01	189104-01
A	100	34 / 45	24 / 40	189100-22	189102-01	189101-01	189103-02	189104-01
A	125	34 / 45	24 / 40	189100-23	189102-01	189101-01	189103-01	189104-02
A	125	34 / 45	24 / 40	189100-24	189102-01	189101-01	189103-02	189104-02
B	250	45 / 50	24 / 40	189100-25	189102-02	189101-02	189103-03	189104-03
B	250	45 / 50	24 / 40	189100-26	189102-02	189101-02	189103-04	189104-03
D	300	55 / 50	24 / 40	189100-27	189102-03	189101-04	189103-05	189104-04
D	300	55 / 50	24 / 40	189100-28	189102-03	189101-04	189103-06	189104-04
Suitable for Wiggins Combo Mantles (Three positions Flat Bottom)								
D	500	55 / 50	24 / 40	189100-07	189102-03	189101-04	189103-05	189105-05
D	500	55 / 50	24 / 40	189100-08	189102-03	189101-04	189103-06	189105-05
Suitable for Wiggins Combo Mantles (Three positions Round Bottom)								
D	500	55 / 50	24 / 40	189100-41	189102-03	189101-04	189103-05	189104-05
D	500	55 / 50	24 / 40	189100-42	189102-03	189101-04	189103-06	189104-05
D	1000	55 / 50	24 / 40	189100-43	189102-03	189101-04	189103-05	189104-06
D	1000	55 / 50	24 / 40	189100-44	189102-03	189101-04	189103-06	189104-06

Soxhlet Extraction 6-position Heating Plate

The design concept of WH-106 is compactness, safety and efficiency. For compactness, the layout of hotplates has been changed from traditional 6 holes in one row to 3 each in 2 rows, so that we can save 50% operating space.

The distance between each hole is 55mm which is in accord with DIN 44548 and wide enough for users to handle the samples in back row conveniently. WH-106 contains six embedded heating plates with 85mm diameter, and its heating components are made in Germany, rugged and easy to maintain. Each plate with a heating indicator is controlled independently, and the temperature can reach 425°C. For safety reason, each plate is surrounded by a rim for keeping electronics from spilling. The whole housing is made of stainless steel with paint coating.

Applications

- > COD digestion
- > Lipid extraction
- > Kinds of heating

Specification

Model	WH-106
Heating plate	6×Ø85mm diameter cast-iron with embedded heating resistor
Safety	Each top plate is surrounded by a rim that protect electronics from spills. Spacing of 55mm between the heating plate is in accord with DIN 44548.
Max. Temperature	425°C
Control	Each heating plate is controlled independently
Power supply	6×450W
Order No.	178106



Parallel reaction for Soxhlet extraction

Soxhlet Lipid Extraction Apparatus (Suitable for WH-106)

Size	Flask volume (mL)	Extractor Top Joint	Extractor Bottom Joint	Package Order No.	Condenser Order No.	Extractor Order No.	Extraction Thimbles Order No.	Flask volume Order No.
A	125	34 / 45	24 / 40	189100-01	189102-01	189101-01	189103-01	189105-02
A	125	34 / 45	24 / 40	189100-02	189102-01	189101-01	189103-02	189105-02
B	250	45 / 50	24 / 40	189100-03	189102-02	189101-02	189103-03	189105-03
B	250	45 / 50	24 / 40	189100-04	189102-02	189101-02	189103-04	189105-03
B	300	45 / 50	24 / 40	189100-05	189102-02	189101-02	189103-03	189105-04
B	300	45 / 50	24 / 40	189100-06	189102-02	189101-02	189103-04	189105-04
D	500	55 / 50	24 / 40	189100-07	189102-03	189101-04	189103-05	189105-05
D	500	55 / 50	24 / 40	189100-08	189102-03	189101-04	189103-06	189105-05



Specifications for Wiggins Extractor Bodies

Specification	A	B	C	D
Size	A	B	C	D
Use Thimble Size (mm)	25 x 85	35 x 90	35 x 90	45 x 130
Extractor Top Joint	34 / 45	45 / 50	45 / 50	55 / 50
Extractor Bottom Joint	24 / 40	24 / 40	29 / 42	24 / 40
Condenser Bottom Joint	34 / 45	45 / 50	45 / 50	55 / 50
Length of Siphon (mm)	190	260	260	300

Extraction Thimbles - Glass

With a Wiggins fritted disc sealed in, it can be used in any standard Soxhlet extraction apparatus. The sizes below correspond to the size specifications of extraction bodies and will fit those units.

Size	A	A	B/C	B/C	D	D
ID x H (mm)	25 x 85	25 x 85	35 x 90	35 x 90	45 x 130	45 x 130
Sintered glass	20-35um	100-200 um	20-35um	100-200 um	20-35um	100-200 um
Order No.	189103-01	189103-02	189103-03	189103-04	189103-05	189103-06



Extractor Body

Size	A	B	C	D
Extractor Top Joint	34 / 45	45 / 50	45 / 50	55 / 50
Extractor Bottom Joint	24 / 40	24 / 40	29 / 42	24 / 40
Order No.	189101-01	189101-02	189101-03	189101-04



Extraction Apparatus

Bulb type for use with regular extraction apparatus. Improved design permits greater condensing capacity.

Size	A	B/C	D
Extractor Top Joint	34/45	45/50	55/50
Tubing Size (mm)	190	260	300
Height (mm)	275	365	405
Order No.	189102-01	189102-02	189102-03



Extraction Thimbles

CELLULOSE FIBER. Good retention. Seamless, high quality extraction thimbles, single thickness.

Readily permeable to the flow of ether and other organic solvents. Packed 25 per box.



Size (Ø x H)	27 x 80	27 x 60	30 x 80	33 x 94	40 x 123
Order No.	6811-08	6811-14	6811-20	6811-22	6811-24

Flask

Round bottom with short neck and outer joint.

24/40 Joint

Capacity (mL)	100	125	250	300	500	1000
Order No.	189104-01	189104-02	189104-03	189104-04	189104-05	189104-06

29/42 Joint

Capacity (mL)	100	250	500	1000
Order No.	189104-11	189104-13	189104-15	189104-16



Flask

Single Neck, Flat Bottom

24/40 Joint

Capacity (mL)	100	125	250	300	500	1000
Order No.	189105-01	189105-02	189105-03	189105-04	189105-05	189105-06

29/42 Joint

Capacity (mL)	250	300	500	1000
Order No.	189105-13	189105-14	189105-15	189105-16



Temperature and stirring controller

for measuring, control and monitoring

WIGGENS temperature controllers measure, control and monitor applications in laboratories such as heating mantle and chemical reactors.



Ordering Information

Models / Specifications	TCSS	PL524 Pre	PL524 Pro-Stir	PL524 Pro	PC524
Name	Programmable controller for temperature and stirring	Programmable controller for temperature	Temperature and stirring controller	Temperature controller	Safety temperature protector
Screen	5" TFT touch screen	●	●	●	●
Function	LED	●	●	●	●
	Heating	●	●	●	●
	Cooling	●	●	●	●
	Programming	●	●	●	●
	Stirring	●	●	●	●
Interface	Safety temperature	●	●	●	●
	RS485	●	●	●	●
	RS232	●	●	●	●
	Ethernet	●	●	●	●
	USB-A	●	●	●	●
Options	Alarm	●	●	●	●
	Pt100	○	○	○	○
	Thermocouple	○	○	○	○
	heating mantle matching unit	○ please reference Note 3	○	○	○
	Solenoid valve for cooling WH260 series	○	○	○	○



Temperature,Stirring Speed,Cooling Valve Controller



Programmable temp. Control and security protection



Temp. and Stir. Controller



Temp. Control and safety protection



Overheated safety protection

Note 1 : ● Standard configuration ○ Options

Note 2 : TCSS, PL524 Pre, PL524 Pro-Stir, PL524 Pro working with two temperature sensors; PC524 just need one temperature sensor

Note 3 : TCSS-1 matching with heating-stirring mantle, PL524pro-Stir matching with heating-stirring mantle

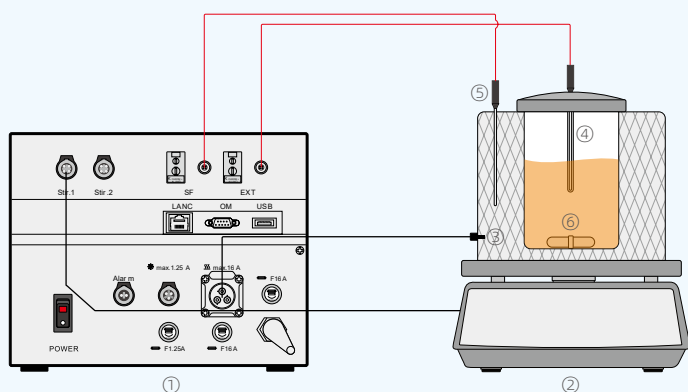

Application

The external system (e.g. heating mantle and magnetic stirrer) is connected via the socket at the back. Different sensors for working and safety temperatures control the application.

- ① TCSS-1
- ② Magnetic stirrer
- ③ Heating mantle
- ④ Working sensor
- ⑤ Safety sensor
- ⑥ stirring bar

Heating Mantles

Aluminum Housed Mantles

- > Rigid housing provides strength and durability while supporting the weight of the vessel
- > Fabric interior to softly nest glass vessels and reduce the chance of thermal shock
- > Adaptable to most vessels including larger sizes
- > Withstands 450°C internal operating temperature (650°C for Series STM), enough power for most applications
- > Can be adapted to special applications with custom sizes, bottom holes, and special electrical devices
- > Feet on smaller sizes designed to provide stability and promote cooler exterior temperatures

Spherical Flask Mantles

- > The Series TM spherical flask mantle covers only the flask's bottom half, letting you see its full contents. Larger sizes have multiple circuits for ease of temperature control when a flask is less than half full. Splash Guards can be used with TM102 through TM117.
- > Poncho Safety Shields can be used with sizes 500 ml (TM107) and larger.

Specifications

Complete System Order No.	Order No.	Flask Capacity mL	Max. Flask Diameter mm	Watts W	Depth mm	Outside Dia. mm	Height mm	Weight kg
WTM95	TM95	50	48	60	24	159	121	1.0
WTM97	TM97	100	60	80	30	159	121	1.0
WTM99	TM99	125	70	80	35	159	121	1.0
WTM101	TM101	200	76	100	38	159	121	1.0
WTM103	TM103	250	83	180	41	159	121	1.1
WTM105	TM105	300	86	180	43	159	121	1.1
WTM107	TM107	500	101	270	51	159	127	1.1
WTM109	TM109	1000	130	380	65	191	127	1.4
WTM111	TM111	2000	170	500	86	254	152	2.1
WTM113	TM113	3000	183	500	91	254	152	2.1
WTM115	TM115	5000	220	600	109	305	178	2.8
WTM117	TM117	12000	293	2@650	147	419	229	6.8
WTM119	TM119	22000	347	2@770	173	483	254	8.5
WTM121	TM121	50000	456	3@1000	228	610	330	18.6
WTM122	TM122	72000	522	3@2000	259	660	356	20.0



WTM series

Spherical flask mantle with temp. control and security protection, the flask is not included



TM series

Spherical flask mantle only, the flask is not included

Stir Mantles

- > The Stir Mantle adds electromagnetic stirring capability (50-750 rpm) to the Series TM heating mantle for spherical flasks. Heating and stirring are independent, choosing either or both. Speed is easily adjusted by a single dial on the PL524pro-Stir.
- > The PL524pro-Stir creates and synchronizes the magnetic field. When restarting (as for removal and reinsertion of the flask), Wiggins exclusive "Synchrostart" feature maintains linkage between the field and the bar. The PL524pro-Stir connects to the StirMantle by cord, so it may be placed outside corrosive hood atmospheres and is easily accessible.
- > PL524pro-Stir connecting cords, and stir bar. Completely grounded and fused.

Specifications

Complete System Order No.	Order No.	Flask Capacity mL	Depth mm	Watts W	Outside Dia. mm	Height mm	Weight kg
EMS103P	EMS103	250	42	180	159	121	2.0
EMS105P	EMS105	300	43	180	159	121	2.0
EMS107P	EMS107	500	51	270	159	133	2.0
EMS109P	EMS109	1000	65	380	191	140	2.4
EMS111P	EMS111	2000	85	500	254	165	2.5
EMS113P	EMS113	3000	91	500	254	165	2.9



Complete system of stir mantle (EMS1XXP)

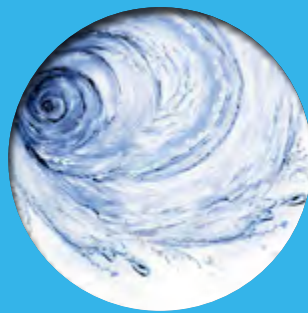

Overhead Stirrer

Overhead stirrer

Attractive design for demanding stirrers & mixing

Our new complete range of laboratory overhead stirrers will meet your high demands every day!



High Torque / High Speed Overhead Stirrer
D series
WB3000-D, WB1800-D, WB6000-D



Remotely Controllable High Torque / High Speed Stirrers,
Suitable for reaction
DF series
WB3000-DF, WB1800-DF, WB6000-DF



Remotely Controllable High Torque / High Speed Stirrers
C & EC Series
WB3000-C, WB1800-C, WB3000-EC, WB1800-EC



WB2000-C



WB2000-M



WOHS-10 Pro



Overhead Stirrer

WOHS-10 Pro / WOHS-15 Pro

Overhead Stirrers of the WOHS range are perfect for stirring and mixing applications. The devices are designed to surpass the requirements of laboratories and institutions around the world with their modern technology and high quality.



TFT Display

TFT display with vivid luminance is easy to read, even from a long distance.



Precise speed control

Easy operation of all parameters using the central turning knob and touch key



Working status indicator

Standby (blue) , Running (green) , Alarm (red)



Brushless DC motor

for long life span, low maintenance and quiet running



Keyless chuck

It allows you to quickly and easily remove the stirring elements without any tools.
Clamping range: 0.5-10mm



Timer

0~99hr99min

Automatic timing function, after start the stirring , the display will automatically start the function: countdown the running time



Temperature measurement

Temperature measuring range: -10~350°C
Temperature measurement resolution: 0.1°C



Direction of rotation

Clockwise or counterclockwise

Model	WOHS-10 Pro	WOHS-15 Pro
Order No.	W3041010	W3041015
Speed range [rpm]	40~2000	40~2000
Setting accuracy speed [rpm]	1	1
Deviation of speed measurement $n > 300$ rpm	±3 %	±3 %
Speed Display	TFT display	TFT display
Clockwise or counterclockwise of stirring	Yes	Yes
Speed setting	Touch key and turning knob	Touch key and turning knob
Time setting range	99h59min59sec	99h59min59sec
Temperature measuring range	-10~350	-10~350
Temperature measurement resolution	0.1	0.1
Working status indicator	Standby (blue) , Running (green) , Alarm (red)	Standby (blue) , Running (green) , Alarm (red)
Power [W]	30	60
Motor principle	Brushless DC motor	Brushless DC motor
Stirring element fastening	Keyless chuck, easy to install and replace the shaft	Keyless chuck, easy to install and replace the shaft
Chuck range diameter [mm]	0.5~10	0.5~10
Hollow shaft, inner diameter [mm]	10.2	10.2
Fastening on stand	Extension arm	Extension arm
Housing material	Cast aluminum coating / thermoplastic polymer	Cast aluminum coating / thermoplastic polymer
Power supply	100~240VAC,50/60Hz	100~240VAC,50/60Hz

Overhead Stirrer

WB2000-M / WB2000-C

WIGGENS® offers overhead stirrers for your stirring and mixing tasks in the lab for low to high viscosities. Safety, power and intelligence are again at the core of the development of this product range. The powerful motors achieve homogeneous results with exact speed even under changing loads or high viscosity and produce little noise. Many reliable solutions are available, according to different requirements in terms of viscosity and volume. WIGGENS® overhead stirrers process stirring quantities of up to 100 liters.

- > Brushless DC motor, which is very suitable for long-term experimental applications
- > Stable and accurate stirring process due to latest micro-processor technology
- > Slow ramp-up and speed limits protect you from splashes
- > Totally enclosed and compact casing
- > The high torque ensures maximum efficiency and minimal processing time even for high-viscosity media
- > Stable and quiet working process
- > Internal overload protection
- > Adjustable impeller shaft for different heights
- > Soft start at low speed guarantees a smooth and safe stirring process
- > Suitable for applications in various environments
- > The standard version package entails the overhead stirrer, a stand, rod, and clamp, as well as a stainless steel impeller
- > Availability of a wide range of different optional impellers

Features of the WB2000-C

- > Employs all basic functions of the WB2000-M overhead stirrer
- > The WB2000-C come with a reversible rotation function
- > The WB2000-C employs button control and a bright LCD speed display
- > Directly connectable to the computer via RS-232 cable for remote control
- > Equipped with digital input/output ports and foot pedal port for various applications
- > Suitable for stirring in reaction systems or stirring applications linked to other equipment
- > Rotation speed can be lowered to 20 rpm for very sensitive stirring processes



Specifications

Model	WB2000-M	WB2000-C
Order No.	100300	100500
Speed range [rpm]	40~2000	40~2000
Setting accuracy speed [rpm]	1	1
Deviation of speed measurement n > 300rpm	±3 %	±3 %
Speed Display	LED display	LCD display
Clockwise or counterclockwise of stirring	No	Yes
Speed setting	Turning knob	Push button
Input power [W]	70	70
Output power [W]	50	50
Motor principle	Brushless DC motor	Brushless DC motor
Torque max. at stirring shaft [N-cm]	66	70
Stirring element fastening	Keyless chuck, easy to install and replace the shaft.	
Chuck range diameter [mm]	0.5~10	0.5~10
Hollow shaft, inner diameter [mm]	10.2	10.2
Fastening on stand	Extension arm	Extension arm
Extension arm diameter [mm]	13	13
Extension arm length [mm]	124	124
Housing material	Cast aluminum coated	
RS232 interface	No	Yes
Dimensions (W x H x D)	105 x160 x185	105 x160 x185
Weight [kg]	11	11
Power supply	100~240VAC,50/60Hz	

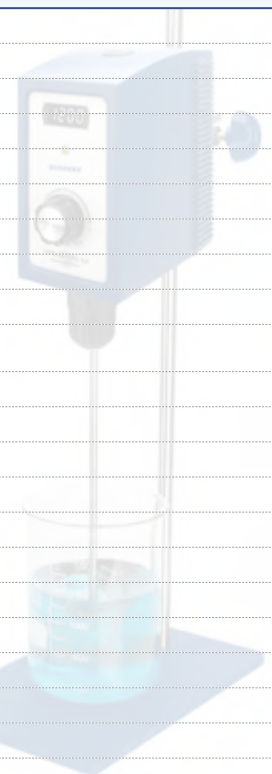

High Torque / High Speed Overhead Stirrer

WB3000-D / WB1800-D / WB6000-D

Specially designed for optimum usability and the highest efficiency in the same class with advanced safety features. Offering the best mixing results, even for challenging application that needs high speed and high torque.

- > Brushless DC motor
- > Totally enclosed and compact metal casing
- > Smart and convenient on-touch control
- > TFT Display for better image quality and easy navigation
- > Bright TFT screen, which can display for monitoring set speed, actual speed and torque
- > Transmission can be switched between low speed / high torque, and high speed / low torque
- > Easily adjustable spinning chuck
- > Precise speed adjustment
- > Set speed can be maintained when viscosity of liquid changes
- > Easy and time saving impeller adjustments
- > Digital and analog interface available
- > Monitoring and control via PC software



Height adjustment

A through-shaft design allows for adjusting the impeller position to make height adjustment more convenient



Ease of operation

Smart and convenient on-touch control



Precise speed adjustment

Speed Range 20-3000rpm, maintenance of constant motor speed by PID feedback control system even under conditions of changing viscosity.



RS232 / RS485

The stirrer comes equipped with an RS232 and an RS485 interface to control and document all parameters.



Brushless DC motor

for longer life span, low maintenance and higher efficiency



Keyless chuck

It allows you to quickly and easily remove the stirring elements without any tools. Clamping range: 0.5-10mm



TFT Display

for better image quality and easy navigation



High Torque / High Speed

Offering the best mixing results, even for challenging applications



Specifications

Please note that other overhead stirrer models are available on request, please contact Wiggins for further information.

Model	WB3000-D	WB1800-D	WB6000-D
Order No.	100400	100600	100800
Speed range [rpm] ¹⁾	30~600 (I) 601~3000 (II)	20~360 (I) 361~1800 (II)	60~1200 (I) 1201~6000 (II)
Setting accuracy speed [rpm]	1	1	1
Deviation of speed measurement n > 300rpm	±3 %	±3 %	±3 %
Speed Display	TFT display	TFT display	TFT display
Clockwise or counterclockwise of stirring	Yes	Yes	Yes
Speed setting	Touch key and turning knob	Touch key and turning knob	Touch key and turning knob
Power [W]	150	150	150
Motor principle	Brushless DC motor	Brushless DC motor	Brushless DC motor
Torque max. at stirring shaft [N-cm] ²⁾	339(I) / 68(II)	563(I) / 113(II)	170(I) / 34(II)
Stirring element fastening	Keyless chuck, easy to install and replace the shaft.	Keyless chuck, easy to install and replace the shaft.	Keyless chuck, easy to install and replace the shaft.
Chuck range diameter [mm]	0.5~10	0.5~10	0.5~10
Hollow shaft, inner diameter [mm]	10.2	10.2	10.2
Fastening on stand	Extension arm	Extension arm	Extension arm
Extension arm diameter [mm]	13	13	13
Extension arm length [mm]	124	124	124
Housing material	Cast aluminum coating	Cast aluminum coating	Cast aluminum coating
RS232 / RS485 interface	Yes	Yes	Yes
Dimensions (W x H x D)	200 x 95 x 230	200 x 95 x 230	200 x 95 x 230
Weight [kg]	5	5	5
Power supply	100~240VAC,50/60Hz	100~240VAC,50/60Hz	100~240VAC,50/60Hz

1) Two grades of stirring speed are for this series. The low-speed has more torque, suitable for chemical reaction system. And the high-speed is suitable for sample pretreatment. According to the set speed, it can be switched automatically between them.

2) The two speed ranges correspond to different maximum torque.

Remotely Controllable High Torque / High Speed Stirrer keyless chuck

WB3000-DF / WB1800-DF / WB6000-DF

Ideally perform your professional stirring tasks requiring high functionality, safety, and longevity. Prestige touch TFT controller, especially for applications where the remote controller is needed

Features

- > With all the functions and features of D-series overhead stirrers, vibration-free and silent operation.
- > Equipped with a maintenance-free BLDC motor to generate smooth, quiet, and yet powerful stirring.
- > Powerful torque capable of handling high viscosity tasks.
- > Maintenance of constant motor speed by control system even under conditions of changing viscosity.
- > Best effort function intelligently manages its stirring speed to keep stirring even if the workload is out of its capacity.
- > Prevention of accidental spills or splashes thanks to microprocessor controlled smooth start and stop functions.



A through-shaft design allows for adjusting the impeller position to make height adjustment more convenient



Keyless chuck

It allows you to quickly and easily remove the stirring elements without any tools. Clamping range: 0.5-10mm

Specifications

Model	WB3000-DF	WB1800-DF	WB6000-DF
Order No.	100400F	100600F	100800F
Speed range [rpm] ¹⁾	30~600 (I) 601~3000 (II)	20~360 (I) 361~1800 (II)	60~1200 (I) 1201~6000 (II)
Setting accuracy speed [rpm]	1	1	1
Deviation of speed measurement n > 300rpm	±3 %	±3 %	±3 %
Speed Display	TFT display	TFT display	TFT display
Clockwise or counterclockwise of stirring	Yes	Yes	Yes
Speed setting	Touch key and turning knob	Touch key and turning knob	Touch key and turning knob
Power [W]	150	150	150
Motor principle	Brushless DC motor	Brushless DC motor	Brushless DC motor
Torque max. at stirring shaft [N·cm] ²⁾	339(I) / 68(II)	563(I) / 113(II)	170(I) / 34(II)
Stirring element fastening	Keyless chuck, easy to install and replace the shaft.	Keyless chuck, easy to install and replace the shaft.	Keyless chuck, easy to install and replace the shaft.
Chuck range diameter [mm]	0.5~10	0.5~10	0.5~10
Hollow shaft, inner diameter [mm]	10.2	10.2	10.2
Fastening on stand	Extension arm	Extension arm	Extension arm
Extension arm diameter [mm]	13	13	13
Extension arm length [mm]	124	124	124
Housing material	Cast aluminum coating	Cast aluminum coating	Cast aluminum coating
RS232 / RS485 interface	Yes	Yes	Yes
Dimensions of motor (W x H x D)	200 x 95 x 230	200 x 95 x 230	200 x 95 x 230
Weight	4.5	4.5	4.5
Power supply	100~240VAC,50/60Hz	100~240VAC,50/60Hz	100~240VAC,50/60Hz

1) Two grades of stirring speed are for this series. The low-speed has more torque, and is suitable for chemical reaction system. And the high-speed is suitable for sample pretreatment. According to the set speed, it can be switched automatically between them.

2) The two speed ranges correspond to different maximum torque.

Remotely Controllable High Torque / High Speed Stirrer

WB3000-C / WB1800-C / WB3000-EC / WB1800-EC

- > Suitable for reaction systems and other high torque / high speed applications
- > Set speed can be maintained when viscosity of liquid changes
- > Brushless DC motor made in Germany, for high performance stirring processes
- > Maintenance-free
- > Quiet and reliable
- > Digitally adjustable rotation speed and direction
- > Remote controller can display actual speed and actual torque as well as the set speed
- > Digital (RS-232/485) and analog communication available for remote PC or PLC control



Features

- > Vibration-free and silent operation.
- > Powerful torque capable of handling high viscosity tasks.
- > Maintenance of constant motor speed by control system even under conditions of changing viscosity.
- > Best effort function intelligently manages its stirring speed to keep stirring even if the workload is out of its capacity.
- > Prevention of accidental spills or splashes thanks to microprocessor-controlled smooth start and stop functions.

Practical external controller.

- > Intuitive and easy control with touch TFT.
- > It enables convenient and safe external control without opening the sash of the fume hood or safety cabinet.
- > Compact and slim head design for diverse flexibility in configuring other test equipment and accessories. (optional)

Safety

- > Sturdy aluminum main body efficiently absorbing and emitting the heat generated by the motor.
- > Separated adapter from the main body minimizes the risks of electrical hazards to the users.



Specifications

Model	WB3000-C	WB1800-C	WB3000-EC	WB1800-EC
Order No.	100401	100601	100402	100602
Speed range [rpm]	70~3000	20~800	70~3000	20~800
Setting accuracy speed [rpm]	1	1	1	1
Deviation of speed measurement n > 300rpm	±3 %	±3 %	±3 %	±3 %
Speed Display	TFT display	TFT display	TFT display	TFT display
Clockwise or counterclockwise of stirring	Yes	Yes	Yes	Yes
Speed setting	Touch key and turning knob	Touch key and turning knob	Touch key and turning knob	Touch key and turning knob
Power [W]	150	150	450	450
Motor principle	Brushless DC motor	Brushless DC motor	Brushless DC motor	Brushless DC motor
Torque max. at stirring shaft [N-cm]	330	1320	410	1640
Housing material	Powered coated SS housing	Powered coated SS housing	Powered coated SS housing	Powered coated SS housing
RS232 / RS485 interface	Yes	Yes	Yes	Yes
Dimensions of motor (W x H x D) [mm]	95 x 215 x 150	95 x 215 x 150	95 x 215 x 150	95 x 215 x 150
Weight (Stirrer / Controller) [kg]	3.4 / 0.5	3.4 / 0.5	3.4 / 0.5	3.4 / 0.5
Power supply	100~240VAC,50/60Hz	100~240VAC,50/60Hz	100~240VAC,50/60Hz	100~240VAC,50/60Hz

Accessories for Overhead Stirrer

Stirrer guides

Universal stirrer seal

Material : PTFE (Polytetrafluoroethylene)

Best-seller!



Order No.	ShaftØ (mm)	Joint Size	Height (mm)
KA22-02	8	24/40	60
KA22-03	8	29/42	60
KA22-04	8	34/45	60

Universal stirrer guides For standard taper ground glass joints

Universal stirrer guides for use with standard taper ground glass joints can be used with PTFE Shaft Stirrers, glass and metal shaft stirrers. Unique features of the design are a permanently loaded Composite PTFE/PEEK Seal, a Glass Ball-Bearing for rigidity and smoothness of operation.

- > Exceptional chemical resistance
- > Anti-whip and reduced vibration
- > Vacuum (5mmHg) and pressure (3-5psi) performance
- > No shedding
- > Maximum recommended speeds: continuous 500rpm, intermittent 800rpm



Best-seller!

Order No.	ShaftØ (mm)	Joint Size	Height (mm) excl.joint	GuideØ (mm)
5.101.1.7	6	19/22	96	45
5.102.7	6	24/40	96	45
5.104.7	8	24/40	96	45
5.105.7	10	24/40	96	45
5.106.7	10	29/42	96	45
5.108.7	12	29/42	110	55

High performance stirrer guides For standard taper ground glass joints

This product is designed to provide an effective guide for Glass and Metal Shaft stirrers over a range of temperatures without shedding particles from the seal, whilst maintaining a vacuum. The seal is manufactured from a specially formulated PTFE-PEEK composite and is permanently pressure loaded.

- > The HP Stirrer Guide has the additional features:
- > High level of chemical resistance
- > Anti-whip and reduced vibration
- > Vacuum (~5mm Hg) and pressure (3-5psi) performance
- > No shedding
- > Self-releasing joint ring
- > Maximum recommended speeds: continuous 500rpm, intermittent 800rpm

Note: PEEK has a very high level of chemical resistance with some susceptibility only to strong mineral acids

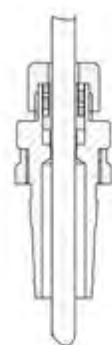

Order No.	ShaftØ(mm)	Joint Size	Height (mm) excl.joint	GuideØ (mm)
5.0.0619	6	19/22	60	42
5.0.0624	6	24/40	60	42
5.0.0819	8	19/38	60	42
5.0.0824	8	24/40	60	42
5.0.1024	10	24/40	60	42
5.0.1029	10	29/42	60	50
5.0.1034	10	34/45	60	50
5.0.1045	10	45/50	60	58
5.0.1229	12	29/42	70	50
5.0.1945	19	45/50	70	58

High vacuum stirrer guides

The newest design of mechanical stirring seals with all parts that are in contact with liquid or vapor being made of PTFE, RULON, or PEEK material. It doesn't harm the stirring rod and is highly chemical resistant. It can be used with vacuum of up to 1 Torr. The highest recommended stirring speed is 400 rpm.



Order No.	ShaftØ (mm)	Joint Size	Replace O-Ring
8050-02	10	24/40	7859-526
8050-04	10	29/42	7859-534
8050-14	10	29/32	7859-534
8050-10	10	#15 Ace-Thred	7859-530
8050-12	10	#25 Ace-Thred	7859-534
8050-06	19	45/50	7859-573
8050-16	25.4	45/50	7859-573
8050-08	28	45/50	7859-573
8050-18	30	45/50	7859-573

Magnetic stirrer guides

Magnetic drives are designed for agitating a fully vacuumed flask.
Multi-functional and easy to replace impeller.

- > Use of rare-earth elements which is Neodymium (Nd), Samarium (Sm-Co) magnet.
- > High-speed rpm, vibration free.
- > Specifically designed with permanent magnets which has a dynamic torque rating.
- > Small size and powerful rotating magnetic drive is useful both for laboratory and manufacturing applications.

Specifications

Model	MD-24	MD-29	MD-45	MD-15	MD-25
Ground Joint	24/40	29/42	34/45	Thread #15	Thread #25
Body / Housing	SUS316L / CR-PLATE				
Bushing / Seal	PTFE/Viton				
Vacuum	1×10 ⁻⁴ mmHg				
Pressure	5 bar				
Temp	Max. 70°C (without cooling), Max. 300°C (with cooling)				
Shaft Size (Ø, mm)	8 mm				
Cooling in / out Size (Ø, mm)	3.2 mm				
Dimension (Ø×L, mm)	50×200mm				
Weight (kg)	1.02	1.04	1.08	1.00	1.02
Order No.	511001	511002	511003	511004	511005



Application of Magnetic Drive

PTFE Impeller

- > Stainless steel core surrounded by PTFE mantle
- > Chemical resistant
- > Economically friendly
- > Strong structure which doesn't break easily
- > Can be used up to a max. temperature of 280°C
- > The stainless steel core is revealed at the upper part and can be plugged into the stirrer
- > The length of the revealed part is 50mm

EX = Exposed Shaft.

Shafts of 650mm, 750mm & 1000mm in length are produced with a stainless steel core with an exposed end for more rigid clamping to the chuck drive
Shafts up to 12mm diameter have an exposed end of 50mm long and 6.5mm diameter.
Shafts of 16mm diameter have an exposed end of 50mm long and 8.5mm diameter.

Screw Propeller, 4-Bladed (PTFE Coated)

Creates shearing force. Used for mixing media in an up-to-down axial flow, for mid and high-speed stirring, and for mid and low viscosity.



Order No.	Shaft Ø(mm)	Length(mm)	Rotor Ø(mm)
5.230.2	6	300	40
5.240.2	6	400	40
5.250.2	6	500	50
5.230.8.2	8	300	40
5.240.8.2	8	400	40
5.250.8.2	8	500	50
5.255.10.2	10	550	70
5.0265.10.2	10	650EX	70
5.0275.10.2	10	750EX	70
5.0265.12.2	12	650EX	80
5.0275.12.2	12	750EX	80
5.02100.12.2	12	1000EX	80
5.0275.16.2	16	750EX	80
5.0275.16.1.2	16	750EX	100
5.02100.16.2	16	1000EX	100
5.02100.16.1.2	16	1000EX	120

Centrifugal Stirrer, 2-Bladed (PTFE Coated)

2-Blade Impeller which will open up depending on the stirring speed. Used for round vessels with narrow openings, for mixing media in an up-to-down axial flow, for mid and high-speed stirring



Order No.	Shaft Ø(mm)	Length(mm)	Rotor Ø(mm)
5.430.2	6	300	40
5.440.2	6	400	40
5.450.2	6	500	50
5.430.8.2	8	300	40
5.440.8.2	8	400	40
5.450.8.2	8	500	50
5.455.10.2	10	550	70
5.0465.10.2	10	650EX	70
5.0475.10.2	10	750EX	70
5.0465.12.2	12	650EX	80
5.0475.12.2	12	750EX	80
5.04100.12.2	12	1000EX	80
5.0475.16.2	16	750EX	80
5.04100.16.2	16	1000EX	80

Anchor Impeller (PTFE Coated)

Produces tangential flow and strong shearing force. Used for slow-speed stirring, for high viscosity mixtures.



Order No.	Shaft Ø(mm)	Length(mm)	Rotor Ø(mm)
5.330.2	6	300	80
5.340.2	6	400	80
5.350.2	6	500	80
5.330.8.2	8	300	80
5.340.8.2	8	400	80
5.350.8.2	8	500	80
5.355.10.2	10	550	100
5.0365.10.2	10	650EX	140
5.0375.10.2	10	750EX	140
5.0365.12.2	12	650EX	140
5.0375.12.2	12	750EX	140
5.03100.12.2	12	1000EX	140
5.0375.16.2	16	750EX	140
5.0375.16.1.2	16	750EX	180
5.03100.16.2	16	1000EX	140
5.03100.16.1.2	16	1000EX	180

Retreat Curve Impeller (PTFE Coated)

The blades are formed in a 30° angle. It creates tangential and axial flow as well as high shearing force. Used for mid- and slow-speed stirring, and for all levels of viscosity.



Order No.	Shaft Ø(mm)	Length(mm)	RotorØ(mm)	Blade Ht(mm)
5.80850.300	8	300	50	10
5.80875.300	8	300	75	15
5.80850.400	8	400	50	10
5.80875.400	8	400	75	15
5.81050.400	10	400	50	10
5.81075.400	10	400	75	15
5.81050.500	10	500	50	10
5.81075.500	10	500	75	15

Blades (PTFE Coated)

Impeller blades that fit to "Impeller Shaft, with Hook (PTFE Coated)". Completely inert and highly scratch-resistant. (Hole diameter: 6.5 mm)



Order No.	W(mm)	Ht(mm)	Order No.	W(mm)	Ht(mm)
2.052.1	52	14	2.1065.1	65	25
2.076.1	76	19	2.1075.1	75	25
2.090.1	90	28	2.1105.1	105	25
			2.1125.1	125	25
			2.1150.1	150	25

4 Blade Angled Type 45° Metric

Order No.	Shaft Ø(mm)	RotorØ(mm)
5.606040	6	40
5.608040	8	40
5.610060	10	60
5.610090	10	90
5.612070	12	70
5.612090	12	90
5.616100	16	100



Plain Impeller Shafts (PTFE Coated)

Plain shafts with a stainless steel core and PTFE coating, as well as an exposed stainless steel end.



Order No.	Shaft Ø(mm)	End Ø(mm)	LengthØ(mm)
5.100830EX	8	5	300
5.100850EX	8	5	500
5.101030EX	10	6.4	300
5.101050EX	10	6.4	500
5.101065EX	10	6.4	650
5.101250EX	12	6.4	500
5.101265EX	12	6.4	650
5.101275EX	12	6.4	750
5.1016750EX	16	10	750
5.1016100EX	16	10	1000

Impeller Shafts for Blades (PTFE Coated)

Shafts with a stainless steel core, PTFE coating, an exposed stainless steel end, as well as a hook for mounting blades



Order No.	Shaft Ø (mm)	Length (mm)	Order No.	ShaftØ (mm)	Length (mm)
5.530.1	6	300	5.0565.10.1	10	650EX
5.540.1	6	400	5.0575.10.1	10	750EX
5.550.1	6	500	5.05100.10.1	10	1000EX
5.530.8.1	8	300	5.0565.12.1	12	650EX
5.540.8.1	8	400	5.0575.12.1	12	750EX
5.550.8.1	8	500	5.05100.12.1	12	1000EX
			5.0575.16.1	16	750EX
			5.05100.16.1	16	1000EX



Flat Type Metric

Order No.	Shaft Ø(mm)	RotorØ(mm)
5.706070	6	70
5.708070	8	70
5.710070	10	70
5.710100	10	100
5.712100	12	100
5.712150	12	150
5.716100	16	100
5.716150	16	150



Adjustable Turbine

Order No.	Shaft Ø(mm)	RotorØ(mm)
5.90850	8	50
5.90875	8	75
5.91075	10	75
5.9100100	10	100
5.91275	12	75
5.912100	12	100
5.016100	16	100
5.916150	16	150



Stainless Steel Impellers

Pivoting Blade Impeller

For mixing media from coarse to liquid, for mid-speed stirring, and for mid to low viscosity mixtures.

Blade Height: 18 mm



Order No.	Rotor Ø(mm)	Shaft Ø(mm)	Length(mm)
9603	60	8	300
9604	60	8	400
9605	60	8	500

Straight 2-Blade Impeller

For mixing media from coarse to liquid, for mid-speed stirring, and for mid to low viscosity mixtures.

Blade Height: 12 mm



Order No.	Rotor Ø(mm)	Shaft Ø(mm)	Length(mm)
9703	50	8	300
9704	50	8	400
9705	50	8	500

3-Hole Blade Impeller

For mixing media from coarse to liquid, for mid-speed stirring, and for mid to low viscosity mixtures.



Order No.	Rotor Ø(mm)	Shaft Ø(mm)	Length(mm)
9403	50	8	300
9404	50	8	400
9405	50	8	500
9406	100	10	300
9407	100	10	400
9408	100	10	500

Straight 4-Blade Impeller

For mixing media from coarse to liquid, for mid-speed stirring, and for mid to low viscosity mixtures.

Blade Height: 12 mm



Order No.	Rotor Ø(mm)	Shaft Ø(mm)	Length(mm)
9053	50	8	300
9054	50	8	400
9055	50	8	500
9056	100	10	300
9057	100	10	400
9058	100	10	500

6-Hole Blade Impeller

For mixing media from coarse to liquid, for mid-speed stirring, and for mid to low viscosity mixtures.



Order No.	Rotor Ø(mm)	Shaft Ø(mm)	Length(mm)
9503	50	8	300
9504	50	8	400
9505	50	8	500
9506	100	10	300
9507	100	10	400
9508	100	10	500

Pitched Leaf Impeller and Pitched Blade Impeller

Employs small shearing force. Used for mixing media in an up-to-down axial flow, for mid- and high-speed stirring, for mid to low viscosity mixtures.

Blade Height: 12 mm



Order No.	Rotor Ø(mm)	Shaft Ø(mm)	Length(mm)
9003	50	8	300
9004	50	8	400
9005	50	8	500
9009	100	8	300
9010	100	8	400
9011	100	8	500
9012	70	8	500
9013	100	10	650
9014	100	10	800

Turbine Impeller

Creates shearing force. Used for mixing media in an up-to-down axial flow, for mid and high-speed stirring, for mid to low viscosity mixtures.



Order No.	Rotor Ø(mm)	Shaft Ø(mm)	Length(mm)
9025	45	7	400
9026	65	7	400
9025A	45	8	400
9026A	65	8	400

Centrifugal Impeller

2-Blade Impeller which will open up depending on the stirring speed. Used for round vessels with narrow openings, for mixing media in an up-to-down axial flow, for mid- and high-speed stirring.

Blade Height: 10 mm



Order No.	Rotor Ø(mm)	Shaft Ø(mm)	Length(mm)
9209	90/15	8	300
9210	90/15	8	400
9211	90/15	8	500
9212	90/15	10	300
9213	90/15	10	400
9214	90/15	10	500
9215	90/15	10	650

Propeller Stirrers, 3 Fix Blades

- > Rpm-range middle
- > Mixing of media with low and middle viscosity
- > Ideal for homogenising and suspending
- > Axial flow

Blade Height: 12 mm



Order No.	Rotor Ø(mm)	Shaft Ø(mm)	Length(mm)
9103	50	8	300
9104	50	8	400
9105	50	8	500
9109	70	8	300
9110	70	8	400
9111	70	8	500
9112	100	10	300
9113	100	10	400
9114	100	10	500
9115	70	10	650
9116	100	10	800

Anchor Impeller

Produces tangential flow and strong shearing force. Used for slow-speed stirring, for high viscosity mixtures.



Order No.	Rotor Ø(mm)	Shaft Ø(mm)	Length(mm)
9610	70	8	500
9611	90	10	650
9612	140	10	800

Radial Flow Impeller

Creates a strong flow and shearing force. Used for mixing media in an up-to-down axial flow, for mid-speed stirring, for mid viscosity under 500mpas. Especially useful for aerating.

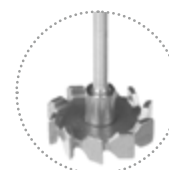

Order No.	Rotor Ø(mm)	Shaft Ø(mm)	Length(mm)
9030	50	8	400
9031	50	10	400

Multi-Purpose Impeller

Can generally be used in low to high viscosity mixtures. Even with slow stirring speed, it will produce a very good radial stirring outcome.



Order No.	Rotor Ø(mm)	Shaft Ø(mm)	Length(mm)	Rpm
9020	80	10	500	200-700
9021	120	10	500	120-500

Clamps



Three-Prong Clamps

	Overall length(mm)	Maximum grip size(mm)	Order No.
Large Clamp	270	80	KA00-52
Medium Clamp	245	60	KA00-53
Small Clamp	210	30	KA00-54
Large Clamp	615 (Rod: 500)	80	KA00-52A

Two-Prong Clamps

Two-Prong Clamp, or dual adjustment clamp has a maximum grip size of 73mm. Two-prong design is ideal for beakers, flasks, and test tubes. Jaws adjust independently. Overall length is 255mm. Clamp extends 127mm.



	Overall length(mm)	Maximum grip size(mm)	Order No.
Medium Clamp	255	60	KA00-50
Medium Clamp	605 (Rod: 500)	60	KA00-50A

Utility Clamp Flat

Grips rods up to 3/4 in. diameter (19mm). The holding angle of the jaws is adjustable. It can be locked with a wingnut. Wingnut also allows length adjustment. Two-prong flat jaws are for test tubes. Three-prong are for irregular shapes. Vinyl and fiber glass sleeves are included. Replacement sleeves are available: Contact your Fisher Customer Service Representative.



Description	Order No.
2P direct connection	KA00-57

Clamp Swivel Holder

Material : Brass (Chromium plating)
Adjustable angle holder, different from other holders fixed at 90 degrees



Description (Max Grip)	Order No.
Ø13mm	KA00-71B

Ring Clamp

Material : Stainless Steel (Chromium plating)
For Funnel & Separatory Funnel



Description (ID)	Order No.
Ø90mm	KA00-65
Ø70mm	KA00-66
Ø50mm	KA00-67

Utility Clamp 3Prong

Grips rods up to 3/4 in. diameter (19mm). The holding angle of the jaws is adjustable. It can be locked with a wingnut. Wingnut also allows length adjustment. Two-prong flat jaws are for test tubes. Three-prong ones are for irregular shapes. Vinyl and fiber glass sleeves are included.



Description	Order No.
3P direct connection	KA00-58

Square Clamp Holder

Material : Die Casting (Chromium plating)
Pipe Diameter : Ø12.7mm



Description	Order No.
Ø12.7mm	KA00-68

Foot

Material : Die Casting (Chromium plating)
Pipe Diameter : Ø12.7mm



Description	Order No.
Ø12.7mm	KA00-73

Extension-Type Ring

Material : Stainless Steel (Chromium plating)
Separatory Funnel Size : 250ml-70mm / 500ml-90mm / 1,000ml-100mm



Description (ID x OD)	Order No.
Ø50 x Ø60mm	KA00-67F
Ø70 x Ø80mm	KA00-67A
Ø90 x Ø100mm	KA00-67B
Ø110 x Ø120mm	KA00-67C
Ø130 x Ø140mm	KA00-67D
Ø150 x Ø160mm	KA00-67E

Clamp Holder (Regular)

Grips rods up to 19mm (included) diameter. It attaches clamps at right angle.



	Order No.
	11080-19

Jumbo Clamp Holder

Heavy-Duty Clamp Holder, or Jumbo clamp holder has a maximum grip size of 22mm. The heavy duty version of the regular holder is for use wherever clamping at 90° angle is required.



Content	Order No.
Max Grip (22mm)	KA00-70A



KA00-50B



KA00-50C

Description (Max Grip×Length)	Order No.
60 x 360, 2P	KA00-50B
60 x 360, 3P	KA00-50C

Pinch Cock

Material : Stainless Steel (Nickel plating)

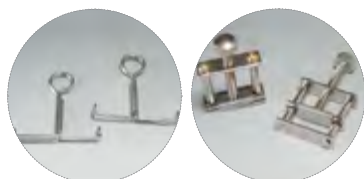

Screw Cock

Material : Brass (Nickel plating)

Content (mm)	Material	Order No.
12	Stainless Steel (Nickel Plating)	KA00-71
12	Brass (Nickel Plating)	KA00-72



The clamping system features a 12-inch or 16-inch flex arm. It is ideal for working within hoods. The system mounts to any lab frame or support stand with a diameter of 19mm or less. An optional base plate or bench clamp provides increased versatility. Complete units (-10 and -12) include flex arm, two-prong head, three-prong head, spring head, and lab frame connector. It comes with an extra set of fiberglass prongs covers temperatures above 100°C .

Order No.	Description
11058-10	Complete clamping system with 300cm arm
11058-12	Complete clamping system with 400cm arm

Spring Steel Clip

Material : Nickel

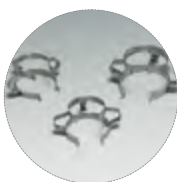

Description	Order No.
14 / 23	KC.KCM14
19 / 26	KC.KCM19
24 / 29	KC.KCM24
29 / 32	KC.KCM29

Clamp Holder All-Position

All-position holder connects at any angle in any plane. It consists of two holders connected by double plate-joint which sets holders 90° from each other. Each holder can be rotated 360°. It grips rods up to 19mm in diameter.



	Order No.
All-Position	11090-17

Chain Clamp

Material : Stainless Steel / Vinyl Coating



Description (Max Grip×Length)	Order No.
165 x 180mm	KA00-56
280 x 180mm	KA00-56A

Frame Holder

Lab frame hook connectors allow one-handed assembly of two components with one adjustment screw.

Material : Die Casting (Chromium plating)

Pipe Diameter : Ø12.7mm



Pipe Diameter	Order No.
12.7mm	KA00-69
12.7mm	KA00-70C

Clamp Universal Swivel, "Power Hold"

Universal swivel clamp allows positioning of stirrer at any compound angle for best stirring action.

One knob — Lets you lower or raise the stirrer

One knob — Locks stirrer the on the support rod, tilts right/left

One knob — Controls swivel setting, forward/backward

It fits support stands with diameters from 3/8 inch to 5/8 inch (9.5mm to 16 mm). It holds stirrer mounting rods with diameters from 3/8 inch to 5/8 inch. It is fabricated of precision-machined aluminum.

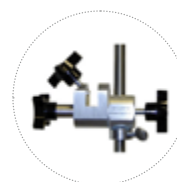

	Order No.
Universal Swivel, "Power Hold"	11084-11

Lifting platform

Laboratory Lifting platform

- > Material : Stainless (#204)
- > Available to support experiment tools such as stirrers, water baths, flasks and etc. in height control
- > Smoothly works with a little force
- > Max Height : 270mm

Description (W x L) cm	Max Height (mm)	Order No.
S/T (15 * 15)	270	KA11-91
S/T (20 * 20)	270	KA11-93
S/T (25 * 25)	270	KA11-94
S/T (30 * 30)	270	KA11-95
S/T (15 * 15)	270	KA11-91N
S/T (20 * 20)	270	KA11-93N
A/L (15 * 15)	270	KA11-91B
A/L (20 * 20)	270	KA11-92



Clamp Holder

For Single Rod Stand

Model	WH1
Clamping range - stand	6~16mm
Clamping range - extension arm	6~16mm
Material	cast aluminium



Clamp Holder

For Double Rod Stand

Model	WH4
Clamping range - stand	16mm
Clamping range - extension arm	10~13mm
Material	cast aluminium



Clamp Holder

For Single Rod Stand

Model	WH2
Clamping range - stand	6~30mm
Clamping range - extension arm	6~16mm
Material	cast aluminium



Extension Rod

Extend the rod to the expected length for your application

Order No.	Diameter (mm)	Height (mm)
WE-11	16	200
WE-12	16	400
WE-13	16	550

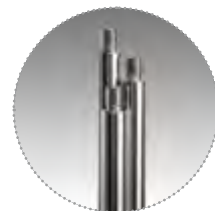

Stands

WF Stand with single rod

Model	Base	Shaft	Dimensions (W x D x Hmm)
WF11	Cast Iron coated powder	Stainless steel	315 x 200 x 550
WF12	Cast Iron coated powder	Stainless steel	315 x 200 x 750
WF13	Cast Iron coated powder	Stainless steel	315 x 200 x 950

WF Stand with double rod and fixing clamp

Model	Base	Shaft	Dimensions (W x D x Hmm)
WF11-D	Cast Iron coated powder	Stainless steel	315 x 200 x 550
WF12-D	Cast Iron coated powder	Stainless steel	315 x 200 x 750
WF13-D	Cast Iron coated powder	Stainless steel	315 x 200 x 950

WF Stand Stainless steel

Suitable for large volume containers. Except the clamp hold, all other parts are made of high quality stainless steel.

Model	Base	Shaft	Dimensions (W x D x Hmm)
WF23-DS	Stainless steel	Stainless steel	635 x 600 x 1010

WH Stand with single rod

Particularly stable stand with H-shape base which prevents the stand from tipping backwards. It provides optimum stability required for larger, heavier instruments and attachments, for example with rheological measurements using overhead stirrers.

Model	Base	Shaft	Container area (W x D mm)	Dimensions (W x D x Hmm)
WH11-S	Aluminum	Stainless steel	252 x 208	340 x 300 x 550
WH12-S	Aluminum	Stainless steel	252 x 208	340 x 300 x 750
WH13-S	Aluminum	Stainless steel	252 x 208	340 x 300 x 950

WH Stand with double rod

Particularly stable stand with H-shape base which prevents the stand from tipping backwards. It provides optimum stability required for larger, heavier instruments and attachments, for example with rheological measurements using overhead stirrers.

Model	Base	Shaft	Container area (W x D mm)	Dimensions (W x D x Hmm)
WH21-D	Aluminum	Stainless steel	226 x 220	340 x 300 x 550
WH22-D	Aluminum	Stainless steel	226 x 220	340 x 300 x 750
WH23-D	Aluminum	Stainless steel	226 x 220	340 x 300 x 1010

WH Electric lift stand

With double rod, equipped with electric lift to head heavy instrument fixed on the stand the user can lift up and lower down the heavy instrument by a single click of the "mouse" connected

Model	Base	Shaft	Stroke (mm)	Container area (W x D mm)	Dimensions (W x D x Hmm)
WH30	Aluminum	Stainless steel	250	370 x 320	450 x 500 x 890

Voltage : 24V, Power: 48W, lifting weight 50kg





Homogenizer

Handheld Homogenizer D-130

When speed & high quality meet
creating power to disperse



Features

- > Use for mixing, emulsification, shredding, or chopping.
- > Practical answer for small samples.
- > Easy to hold and light weight for one hand operation.
- > Autoclavable stainless steel shafts. Inert to aggressive solutions.
- > All shafts are interchangeable shafts and are easily removed for cleanup.
- > High speed motor. Speed control from 8,000 to 30,000 rpm.

Applications

- > General homogenization applications (dispersion and emulsification)
- > Homogenising of tumour tissue sample, for research of diverse tissue diseases
- > Fast dissolving of pills, sugar-coated tablets for quality control purposes
- > Sample preparation for subsequent extraction of pharmaceutical agents (API)
- > Cell disruption, RNA / DNA isolation from tissue
- > Dispersion of small quantities from plants, animals or human tissue
- > Solving of solid materials



Stand
Order No.: 1710130-01

Specifications

Model	D-130
Order No.	1710130
Speed range with zero-load [rpm]	8000~30000
Sample volume H ₂ O [ml]	0.1~50 / 1~250
Power [W]	130
Dispersing shaft	DS-130/5, DS-130/7, DS-130/10, DS-130/14
The wet part for dispersing shaft	316L stainless steel and PTFE
Dimensions without dispersing shaft (W x H x D) [mm]	60×70×240
Weight [kg]	1
Power supply	110V/60Hz or 230V/50~60Hz

Shaft for D-130

Model	DS-130/5	DS-130/7	DS-130/10	DS-130/14
Length	90mm	160mm	150mm	170mm
Rotor diameter	5mm	7mm	10mm	14mm
Volume Range	0.1-50ml	0.3-50ml	1-250ml	2-250ml



High Speed Homogenizer

D-500 / D-500 Pro

Used for homogenizing, emulsifying or suspending. There is a broad spectrum of dispersing tools to choose from.

Features

- > Continuously adjustable speeds for better results
- > Light-weighted and small-dimensioned for better handling
- > Triple safety of the drive (overload protection. Smooth start – against jerky work, safety switch)
- > High quality dispersing tools as standard for better resistance to corrosion (SS 316 L steel)
- > Quick-change system of the dispersing tools for a short changing time between preparations
- > Viscosities up to 10,000 cps
- > One shaft size
- > High quality lab dispersing unit, at a competitive price!
- > D-500pro can maintain constant motor speed by feedback control even under changing loads

Specifications

Model	D-500	D-500 Pro
Speed setting	Knob	Knob
Speed display	Scale	LED
Process Range H ₂ O(mL)	10~40,000mL	10~40,000mL
Speed with Zero-Load (rpm)	10,000~30,000 rpm	500~30,000 rpm
Applicable aggregates	Ø4~Ø23 mm	Ø4~Ø23 mm
Noise Level (dB)	72 dB (30,000 rpm)	66 dB (2500 rpm); 72 dB (30,000 rpm)
Motor	AC	AC
Input / Output Power (W)	500 W	500 W
Supply voltage (V)	220V/50~60Hz	220V/50Hz
Relative humidity (max.)	80% RH	80% RH
Operating temperature	0~40°C	0~40°C
IP Code	IP20	IP20
Dimensions (W x L x H in mm)	Drive:70×70×255 mm	Drive:157×76×236 mm
Weight (kg)	Drive:1.3 kg	Drive:1.8 kg



D-500

D-500 Pro



Shaft Selection Guide for High Speed Homogenizer

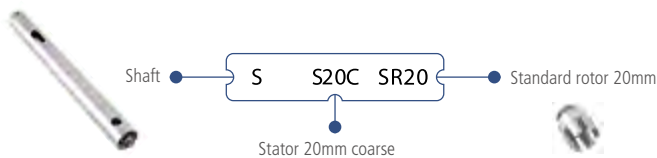

Shaft 5

Includes: Shaft, PTFE bearing, 5 mm stator, 4 mm rotor



SS20CSR20

Includes: Shaft, PTFE bearing, 20 mm stator, standard rotor SR20



SS20FER20

Includes: Shaft, PTFE bearing, 20 mm stator, emulsification rotor ER20



SS30CSR30

Includes: Shaft, PTFE bearing, 30 mm stator, standard rotor SR30



SS30FER30

Includes: Shaft, PTFE bearing, 30 mm stator, emulsification rotor ER30



SS40CMR30

Includes: Shaft, PTFE bearing, 40 mm stator, mixing rotor MR30



Composition Diagram

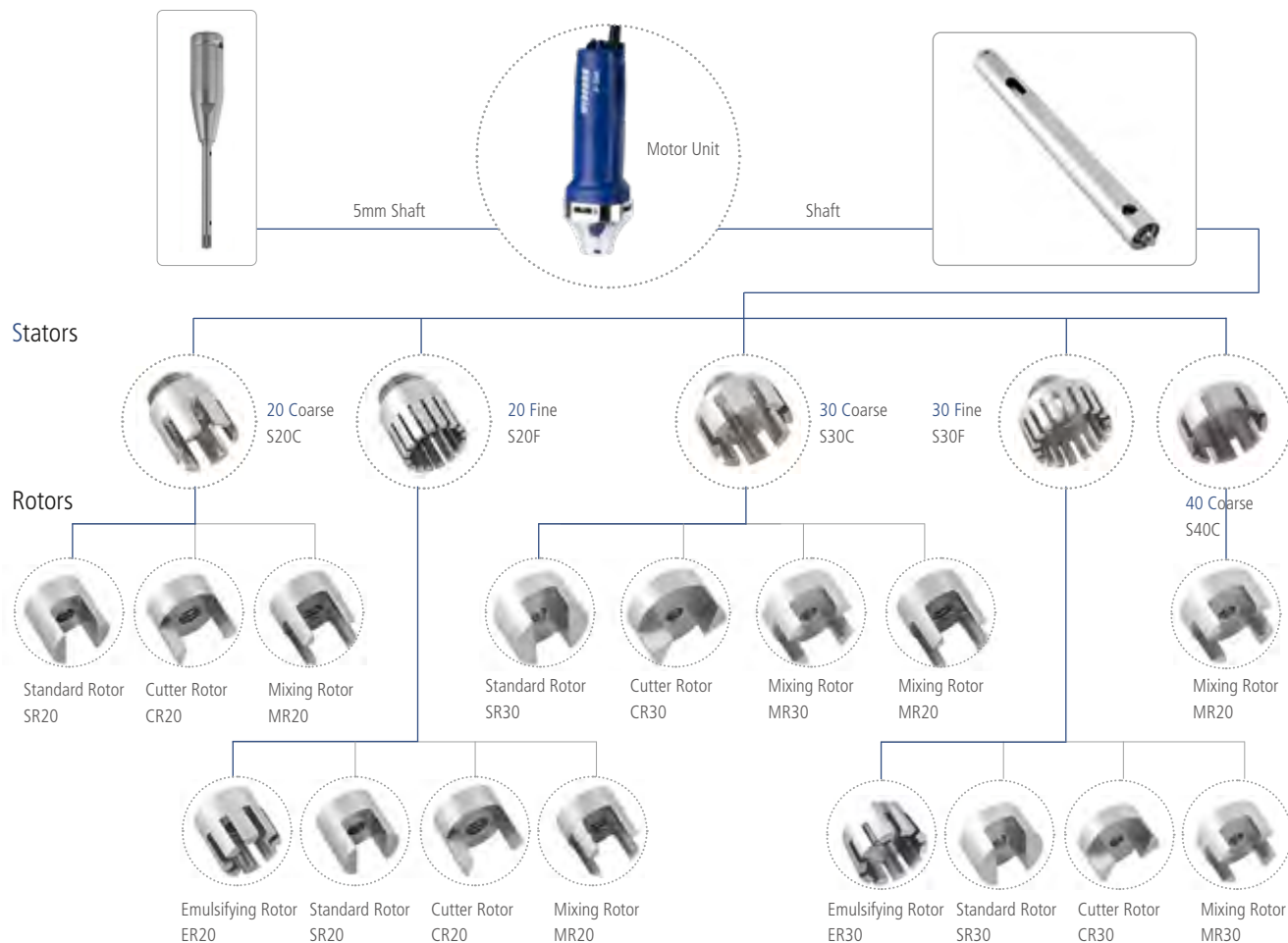

Shaft / Order Table

Rotor Name	Function Description	Process Volume	Linear Velocity	Rotor Diameter	Stator Diameter	Min. / Max.	Ultimate Fineness (in microns)		Disinfection Method	Applications*
Order No.		mL	m/s	mm	mm	Immersion Depth	suspension	emulsion		
SS20CSR20	Solid-Liquid Mixing Material	10-5000	23.5	15	20	40/170	10-50	1-10		P,CI,PC,SD
SS20CCR20	Fiber Material	10-5000	23.5	15	20	40/170	10-50	1-10		SP,M,F,PT,TI
SS20CMR20	Solid-Liquid Mixing Material	10-5000	23.5	15	20	40/170	10-50	1-10		CI,PI
SS20FER20	Latices	10-5000	23.5	15	20	40/170	10-50	1-10		SP,PI,PT,P
SS20FCR20	Fiber Material	10-5000	23.5	15	20	40/170	10-50	1-10		SP,BT,M,F,PT,TI
SS20FMR20	Solid-Liquid Mixing Material	10-5000	23.5	15	20	40/170	10-50	1-10		CI,C,PI,F,PT,PC
SS30CMR20	Stirring Paddle Function	250-20000	36.1	15	30	40/170	High-speed mixer			CI,F,SP
SS30CSR30	Solid-Liquid Mixing Material	100-8000	36.1	23	30	40/170	5-25	1-5		SP,M,F,PT,P
SS30CCR30	Fiber Material	100-8000	36.1	23	30	40/170	5-25	1-5	all methods	SP,M,F,PT,P
SS30CMR30	Solid-Liquid Mixing	100-8000	36.1	23	30	40/170	5-25	1-5		CI,PI
SS30FSR30	Solid-Liquid Mixing Material	100-8000	36.1	23	30	40/170	5-25	1-5		SP,PI,PT,P
SS30FER30	Latices	100-8000	36.1	23	30	40/170	5-25	1-5		SP,PI,PT,P
SS30FMR30	Solid-Liquid Mixing Material	100-8000	36.1	23	30	40/170	5-25	1-5		CI,C,P,F,DT,TI
SS40CMR30	Stirring Paddle	1000-40000	36.1	23	40	40/170	High-speed mixer			CI,F,SP
Shaft 5	Solid-Liquid Mixing Material	0.2-50	6.3	4	5	40/60	10-50	1-10		BT,M
Shaft 10	Solid-Liquid Mixing Material	1-250	6.3	9	10	10/60	10-50	1-10		BT,M
Shaft 14	Solid-Liquid Mixing Material	100-1000ml	6.3	13	14	10/60	10-50	1-10		BT,M

Note: BT = Biology; F = Food Industry; P = Pharmaceutical Industry; C = Cosmetic Industry; M = Medical Analysis; PC = Petrochemical Industry; PT = Paper Production Industry; SP = Wastewater Analysis; CI = Ceramic Industry; CH = Chemical Industry; PI = Paint Industry; TI = Tobacco Industry

Dispersing Vessels

- > Deep baffles improve aeration and mixing, which is crucial for good homogenization. The Wiggins dispersing vessels help to get better experiment result.
- > The flasks or beakers in traditional homogenization or mixing experiment without baffles can easily create a vortex. Since the process will increase the surface between the liquid and air so that there is extra air introducing to the sample. The efficiency of the mixing or homogenization decreases to some extent. Prolonging dispersing time and changing dispersing shaft have to be considered to get optimal result.
- > WIGGENS vessels designed with deep baffles make the mixing procedure easier. The baffles decrease the vortex when the high dispersing speed happens. At higher dispersing speeds, the baffles interrupt the flow in the radial direction and increases counteracting forces. The turbulent liquid flow will get high performance.



Model	Dim. (mm) Ø / H	Working Vol.	Shape	Material	Features	Order No.
DV500	80 / 200	500 ml	Cloverleaf shaped	Borosilicate glass	Top open without cover	W3050100

Stand

- > Strong base for optimal weight distribution
- > Base made of cast iron and shafts made of stainless steel
- > Different heights available
- > Designed for D-500 and D-500Pro homogenizers
- > High quality clamp and fixing set included in the package of stand.

Order No.	Description	Suitable for
WF11-D	Extendable flat bracket (double rod design)	D-500, D-500Pro
11045011	Vessel holder with boss head clamp for WF11-D	WF11-D, WH11-D
11045030	Safety ring for stand WF	WF11-D, WH11-D















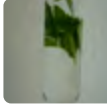

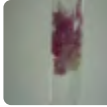

Dispersing tests D-130

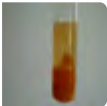
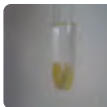
No.	Material	Amount	Pregrinded	Liquid	Vessel	Speed	Duration	Result	Shaft	Test okay? Yes/no	Sample before Dispersing	Sample after Dispersing
1	Rose flower	0.2g	no	5ml water	10ml Conical Tube	level 4	4 min	homogeneous suspension	DS-130/7	yes		
2	Rose flower	0.2g	no	5ml water	10ml Conical Tube	level 6	3 min	homogeneous suspension	DS-130/7	yes		
3	Rose flower	0.1g	no	5ml water	10ml Conical Tube	level 4	1 min	homogeneous suspension	DS-130/10	yes		
4	Rose flower	0.1g	no	5ml water	10ml Conical Tube	level 4	1 min	homogeneous suspension	DS-130/10	yes		
5	Rose stamens	0.05g	no	1.5ml water	2ml Conical Tube	level 4	1 min	homogeneous suspension	DS-130/5	yes		
6	Rose stamens	0.1g	no	2ml water	10ml Conical Tube	level 4	2 min	homogeneous suspension	DS-130/10	yes		

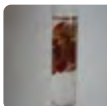

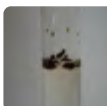

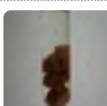
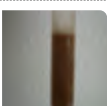

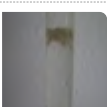
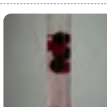
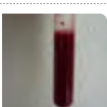
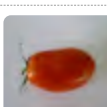



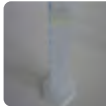



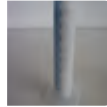





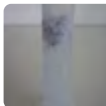





Dispersing tests D-130

No.	Material	Amount	Pregrinded	Liquid	Vessel	Speed	Duration	Result	Remarks	Test okay? Yes/no	Sample before Dispersing	Sample after Dispersing
1	Rape oil	20 drops	no	10 ml water	test tube 16 mm	max.	1 min	stable emulsion		yes		
2	Chicken liver	1 g	5 mm pieces	10 ml water	test tube 16 mm	max.	30 s	homogeneous suspension	sample completely homogenized	yes		
3	Rice	1g	no	10 ml water	test tube 16 mm	max.	1 min	homogeneous suspension	only very small pieces of rice left	yes		
4	Basil leaf	1 piece	5 mm pieces	10 ml water	test tube 16 mm	max.	1 min	homogeneous suspension	only small pieces of leaves left	yes		
5	Spelt flakes	2 g	no	15 ml water	test tube 16 mm	max.	1 min	homogeneous pulp		yes		
6	Cooked ham	2 g	5 mm pieces	50 ml water	150 ml beaker	max.	30 s	homogeneous suspension	only very small pieces of leaves left	yes		
7	Confetti	about 20 pieces	no	10 ml water	test tube 16 mm	max.	1 min	homogeneous cellulose suspension		yes		
8	Wood	1 toothpick	5 mm pieces	10 ml water	test tube 16 mm	max.	1 min	The pick was not grinded	slight abrasion of the wood pieces	no		
9	Tobacco	0,5 cigarettes	no	10 ml water	test tube 16 mm	max.	30 s	homogeneous Pulp	a few fibres stick in the gaps of the stator	yes		
10	Cloves	5 pieces	no	10 ml water	test tube 16 mm	max.	1 min	no grinding effect	no cloves was grinded	no		
11	Mustard seeds	1 g	no	10 ml water	test tube 16 mm	max.	1 min	homogeneous suspension	all seeds were grinded	yes		
12	Herbal tea	0,5 g	no	10 ml water	test tube 16 mm	max.	1 min	homogeneous suspension	the herbal tea was completely Grinded	yes		
13	Sunflower seeds	2 g	no	15 ml water	test tube 16 mm	max.	1,5 min	homogeneous suspension	all seeds were grinded	yes		
14	Dragee	1 piece	no	10 ml water	test tube 16 mm	max.	1 min	homogeneous suspension	the dragee was completely grinded	yes		





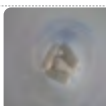





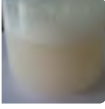

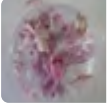
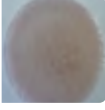





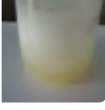





Dispersing tests D-130

No.	Material	Amount	Pregrinded	Liquid	Vessel	Speed	Duration	Result	Remarks	Test okay? Yes/no	Sample before Dispersing	Sample after Dispersing
15	Chicken meat	2 g	5 mm pieces	10 ml water	test tube 16 mm	max.	20 s	homogeneous suspension	part of tendons wrapped around the rotor	yes		
16	Ivy	2 leaves	5 mm pieces	10 ml water	test tube 16 mm	max.	2 min	inhomogeneous suspension	20 % of the leaves were not grinded	no		
17	Rose blossom	2 leaves	5 mm pieces	10 ml water	test tube 16 mm	max.	1 min	homogeneous suspension	some fibres stick in the gaps of the stator	yes		
18	Whole grain Bread	2 g	5 mm pieces	15 ml water	test tube 16 mm	max.	30 s	homogeneous suspension		yes		
19	Carrot	2 g	5 mm pieces	10 ml water	test tube 16 mm	max.	2 min	no grinding effect	carrots are too hard	no		
20	Harzer cheese	2 g	5 mm pieces	10 ml water	test tube 16 mm	max.	10 s	homogeneous sample		yes		
21	Rapes with Kernels	5 pieces	5 mm pieces	10 ml water	test tube 16 mm	max.	1 min	homogeneous suspension	only very small pieces of rapes left	yes		
22	Coffee beans	1 piece	quartered	10 ml water	test tube 16 mm	max.	1 min	homogeneous suspension	only very small pieces of coffee left	yes		
23	Soil sample	1 g	no	10 ml water	test tube 16 mm	max.	30 s	homogeneous suspension	only very small pieces of stones left	yes		
24	Pork meat (fat and sinewy)	1 g	5 mm pieces	10 ml water	test tube 16 mm	max.	1 min	homogeneous suspension	part of tendons wrapped around the rotor	yes		
25	Pet food	1 g	5 mm pieces	10 ml water	test tube 16 mm	max.	30 s	homogeneous suspension	part of tendons wrapped around the rotor	yes		
26	Styrofoam	0,5 cm³	5 mm pieces	10 ml water	test tube 16 mm	max.	1 min	no grinding effect		no		
27	Berries mix	2 g	no	10 ml water	test tube 16 mm	max.	30 s	homogeneous suspension	all berries are grinded	yes		
28	Tomatoes	15 g	10 mm pieces	without	50 ml beaker	max.	2 min	homogeneous tomato pulp	parts of the bowl are not grinded	yes		

Dispersing tests D-500 / D-500Pro

No.	Material	Amount	Pregrinded	Liquid	Vessel	Speed	Duration	Result	Remarks	Test okay? Yes/no	Sample before Dispersing	Sample after Dispersing
1	Rape oil	5 ml	no	80 ml water	100ml measuring cylinder	max.	1 min	stable emulsion		yes		
2	Liver	20 g	10 mm pieces	200 ml water	500 ml beaker	max.	30 s	homogeneous suspension	sample completely homogenized	yes		
3	Rice	20 g	no	80 ml water	100ml measuring cylinder	max.	1 min	homogeneous suspension	only small pieces of rice left	yes		
4	Basil leaf	10 pieces	10 mm pieces	200 ml water	500 ml beaker	max.	1 min	homogeneous suspension	only small pieces of leaves left	yes		
5	Spelt flakes	25 g	no	80 ml water	100ml measuring cylinder	max.	1 min	homogeneous Pulp		yes		
6	Cooked ham	20 g	1 cm pieces	200 ml water	500 ml beaker	max.	30 s	homogeneous suspension	only very small pieces of fibres left	yes		
7	Confetti	about 200 pieces	no	70 ml water	100ml measuring cylinder	max.	1 min	homogeneous cellulose suspension	a very small part stick between the rotor and the stator	yes		
8	Wood	5 toothpicks	1 cm pieces	200 ml water	500 ml beaker	max.	1 min	about 60 % of the picks were grinded	some psrts of the Picks are not grinded and stick	yes		
9	Tobacco	1 cigarette	no	150 ml water	250 ml beaker	max.	1 min	bad homogenizing Most of the tobacco floats ungrinded on the surface	a few fibres stick in the gaps between the rotor and the stator	no		
10	Cloves	30 pieces	no	200 ml water	500 ml beaker	max.	1 min	homogeneous suspension	all cloves were grinded	yes		
11	Mustard seeds	10 g	no	150 ml water	500 ml beaker	max.	1 min	homogeneous suspension	all seeds were grinded	yes		
12	Herbal tea	2 g	no	500 ml water	2 l beaker	max.	1 min	homogeneous suspension	the herbal tea was completely Grinded	yes		
13	Sunflower seeds	20 g	no	150 ml water	500 ml beaker	max.	1 min	homogeneous suspension	all seeds were grinded	yes		
14	Dragees	5 pieces	no	60 ml water	100ml measuring cylinder	max.	1 min	homogeneous suspension	the dragee was completely grinded	yes		

Dispersing tests D-500 / D-500Pro

No.	Material	Amount	Pregrinded	Liquid	Vessel	Speed	Duration	Result	Remarks	Test okay? Yes/no	Sample before Dispersing	Sample after Dispersing
15	Chicken meat	10 g	10 mm pieces	200 ml water	500 ml beaker	max.	20 s	homogeneous suspension	part of tendons wrapped around the rotor	yes		
16	Ivy	10 leaves	10 mm pieces	200 ml water	500 ml beaker	max.	2 min	homogeneous suspension	only very small pieces of leaves left	yes		
17	Rose blossom	10 leaves	10 mm pieces	200 ml water	500 ml beaker	max.	2 min	homogeneous suspension	only very small pieces of leaves left	yes		
18	Whole grain Bread	20 g	10 mm pieces	200 ml water	500 ml beaker	max.	2 min	homogeneous suspension	the vessel must be moved	yes		
19	Carrot	10 g	10 mm pieces	200 ml water	500 ml beaker	max.	2 min	homogeneous suspension	the vessel must be moved	yes		
20	Harzer cheese	20 g	10 mm pieces	200 ml water	500 ml beaker	max.	20 s	homogeneous suspension	the vessel must be moved	yes		
21	Rapes with Kernels	5 pieces	10 mm pieces	200 ml water	500 ml beaker	max.	1 min	homogeneous suspension	only very small pieces of rapes left	yes		
22	Coffee beans	10 pieces	no	60 ml water	100ml measuring cylinder	max.	1 min	homogeneous suspension	only very small pieces of coffee left	yes		
23	Soil sample	20 g	no	200 ml water	500 ml beaker	max.	1 min	homogeneous suspension	only very small pieces of stones left	yes		
24	Pork meat (fat and sinewy)	10 g	10 mm pieces	200 ml water	500 ml beaker	max.	1 min	homogeneous suspension	part of tendons wrapped around the rotor	yes		
25	Pet food	20 g	10 mm pieces	200 ml water	500 ml beaker	max.	30 s	homogeneous suspension	part of tendons wrapped around the rotor	yes		
26	Styrofoam	2 cm ³	10 mm pieces	200 ml water	500 ml beaker	max.	1 min	no grinding effect		no		
27	Berries mix	20 g	no	200 ml water	500 ml beaker	max.	30 s	homogeneous suspension	all berries were grinded	yes		
28	Tomatoes	50 g	10 mm pieces	without	250 ml beaker	max.	2 min	homogeneous tomato pulp	the vessel must be moved	yes		

Flapping Homogenizer

From sample preparation.....to microbiological analysis

WIGGENS provides a complete solution



1

Collecting the sample
Place the sample in sterile filter bag. The bag stands upright.



2

Diluting the sample
Add the right amount of diluent into the sterile bag



3

Homogenizing the sample
The sample is homogenized with the Flapping Homogenizer. There is no contact between the sample and the machine to avoid cross-contamination.



5

Pipetting the filtered sample
Preparation of diluted inoculation fluid (gradient) with precision pipetting device from Socorex.



4

Organizing the samples
It is easy to absorb and transfer because the filter bag integrates the filtering effect



6

Preparing your media
Preparation and subpackage of medium with BioFlo ELITE peristaltic pump



7

Plating
Diluting coating method
Please choose Petri dish automatic turntable from WIGGENS



Flat plate crossed inoculation

Please choose automatic sterilization device from WIGGENS for automatic sterilization of inoculation rings



8

Counting the colonies
It is very fast for counting when using the colony counter



Flapping Homogenizer (Stomacher)

- > Flapping Homogenizer is also called Sterile Homogenizer, and can be used to abstract bacteria from solid samples. Put the original samples and the diluents into the sterile bag, then put the bag into the homogenizer. Through the flapping of the paddles, the material in the bag can rapidly reach a homogenized state by the pressure, shaking and vibration.
- > To guarantee the uniformity of the effective extraction of the microorganism inside and on the surface of the solid sample, make sure to include all the material in the sterile bag. The homogenized sample then can be used for the following analysis, and the sterile bag avoids the cross contamination.
- > Using disposable sterile homogeneous bags to guarantee the sample safety and non-contamination, leakless process omits cleaning of the instrument. The advantage of the flapping homogenization is convenient, quick, mild, accurate and good repeatability. Samples will not be contaminated, damaged, heated, and no sterilization as well as no container is needed, thus no container cleaning process either.

Applications:

- > Food microbiological analysis
- > Homogenization of animal tissues, biological samples, and cosmetics
- > Homogenization of meats, fish, vegetables, and fruits
- > Medicines, clinics, molecules, detection of toxins and bacteria



Features

- > Samples in sterilize bag are homogenized by paddles without the risk of cross-contamination.
- > Optimal bacterial extraction without destruction.
- > Leading microprocessor technology for flap control
- > Adjustable flapping speed
- > Working time can be set on continuous or pre-set time
- > Maintenance-free brushless DC motor
- > Stainless steel housing with plastic coating for HG40VW or full stainless for HG400Pro
- > Employ digital setting and display of the working time
- > Digital and analog interface for remote control

HG400 Pro

- > Paralleled paddles stop ease the procession.
- > Tight closure secure bag seal.
- > Quick paddles remove and installation allow you to clean the chamber
- > Illumination unit observation of observing the whole process clearly.



HG400 Pro

- > Useful volume :50-400ml
- > Variable speed :1-10strokes/s
- > Variable blending time : 1s - 59min 59S
- > Paralleled paddles stop
- > Safety drip tray
- > Adjustable blending power

Sterile bag for sampling and samples homogenization.



Easy transportation of the sample

Specifications

Mode	HG400VW	HG400 Pro
Door	SS-Door with Observation Window	SS-Door with Observation Window
Blending volume	50-400mL	50-400mL
Speed	20-600 strokes/min(10-300rpm)	1-10 strokes/s
Variable blending time	1 min to 24h	1 second to 59min 59 s
Exterior dimension (W x D x H, cm)	45 x 21 x 24	45 x 28 x 30
Interior dimension (W x D x H, cm)	10 x 19 x 22	10 x 19 x 22
Power	100-240V /50-60Hz	100-240V /50-60Hz

Accessories for flapping homogenizer

Dilution pipette Acura® manual 810

Air displacement pipette with two pre-calibrated steps allows subsequent pipetting of 1 and 0.1 mL of the same liquid. Metal nozzle fits long straw tips to aspirate from narrow or deep reservoirs (i.e. Stomacher®bags). Ideal alternative to the graduated glass pipettes when performing serial 1:10 dilutions in bacteriology.

Features

- > Two pre-calibrated fixed volumes – no setting required
- > Smooth activation, excellent ergonomics
- > Interchangeable PE nozzle protection filter
- > Justip™ system for height adjustment of the tip ejector
- > Independent calibration for each volume
- > Easy maintenance, cleaning and disinfection
- > Fully autoclavable 121°C / 250 °F



Ordering information

Order No.	Packaging	Description
810.1100	1 / pk	1 mL 0.1 mL
313.1119.40	40 x 25 / pk	Straw tips, polypropylene, sterilized (L: 190 mm, Ø:4 mm)
322.810	100 / pk	Nozzle protection filter, PE material

Simple operation

1. Depress plunger button in full, then release slowly to aspirate 1.1 mL
2. Depress plunger button to first stop, thus dispensing 1 mL in Petri dish
3. Depress plunger button to second stop, thus dispensing residual 0.1 mL in next Petri dish

Order information

Order No.	Name	Capacity	Content
2125C25	Standard bag	400 ml	25 per bag; 20 bags per box
2150C25	Standard bag	400 ml	50 per bag; 10 bags per box
4125C15	Full-page filter bag	400 ml	25 per bag; 20 bags per box
6125C15	Lateral filter bag	400 ml	25 per bag; 20 bags per box
9125R15	Rack for sterilization bags		Position: 10
SMCLIP	Clip for sterilization bags		



Lab Burner

Features

- > Automatic ignition due to piezo effect
- > Max. Temperature: 1300°C
- > Adjustable flame
- > Refillable butane tank

Applications

- > Sterilizing
- > Welding
- > Heating
- > Cooking



Dragon 100



Dragon 200



Dragon 220

Specifications

Model	Dragon 100	Dragon 200	Dragon 220
Max. temperature (°C)	1300	1300	1300
Fuel tanker capacity (g)	45	45	45
Working time (min)	60	60	60
Dim. H x W x D (mm)	161x137x79	92x115x79	94x115x78
weight (g)	380	407	425
Safety switch	yes	--	--
Order No.	177100-00	177200-00	177220-00

Colony Counter

- > Adjustable dish-holder suitable for Petri-dishes of various sizes with diameters ranging from 90 mm to 150 mm or for special 60 mm dishes
- > Pressure sensor allows the use of any marking pen, without the contamination of the sample
- > CE certification
- > Suitable for total bacteria and total coliform counting

Specifications

Model	Galaxy 230
Display	4-Digit Bright Red 0.6" LED Display
Magnification	2 ~ 3 Times
Petri Dish Diameter	60 mm, 90 - 150 mm Adjustable
Zero Reset	Yes
Illumination	Ring-Shaped Lamp
Pressure Sensitivity	Adjustable
Dimensions (W x L x H in mm)	313 x 360 x 346
Net Weight (kg)	5.2



Ordering Information

Order No.	Product Description
175200	Galaxy 230 Colony Counter

Sensor-controlled turntable for Petri dishes

- > The touch-free IR-Sensor technology guarantees extremely simple operation with movements of the hand. Alternatively the new Sensorturn / Sensorturn pro can be operated with a foot pedal.
- > An extraordinarily low working height allows effortless work. The highest degree of sterility is ensured by the device's stainless steel construction.
- > The Sensorturn / Sensorturn pro is a high-performance, UV resistant and flame-sterilizable device.
- > For both options different operating modes are available:
 - Flexible Start-Stop functions or the second timer control with variable rotational periods from 1 - 25 seconds. For longer applications the time can be extended to 125 seconds.
 - A continuously variable rotational speed control of 14 - 110 rpm (Sensorturn) or 14 - 210 rpm (Sensorturn pro) ensures uniform and individual plating of the Petri dishes up to a diameter of 100 mm (optional: up to 150 mm).



Specifications

- > Stainless steel construction
- > Variable rotational speed control:
 - > Sensorturn: 14 - 110 rpm; Sensorturn pro: 14 - 210 rpm
 - > Short time operation 1 - 125 seconds
 - > Turntable with silicone covering & centring ring (autoclavable)
 - > Switch on and off with movements of the hand or foot pedal*
 - > UV-resistant and flame-sterilizable
 - > Minimum space requirement
 - > Includes IR-Sensor and connector for foot pedal
 - > 5 operating modes:
 - > IR-Sensor: Time / Constant
 - > Foot pedal: Standard / Start-Stop / Time
 - > Turntable with transparent silicone covering & centring ring
 - > Screwdriver for IR-Sensor detection range
 - > Power connection

Specifications

Model	Sensorturn	Sensorturn Pro
Rotary speed range	14 - 110 rpm	14 - 210 rpm
Petri dish size	up to Ø 100 mm (Ø 150 mm optional)	
Rotational direction	clockwise	
Detection range IR-Sensor	5 - 50 mm, adjustable	
Connector for foot pedal	yes	
Timer range Time operation	1 - 25 sec or 5 - 125 sec, adjustable	
Constant operation	unlimited	
Operating voltage / input	9 V - 15 V DC / 1.5 VA	
Measurements (w x h x d)	160 x 74 x 109 mm	
Weight	980 g	
Order No.	7.001.000	7.002.000

Accessories

① Foot pedal/stainless steel
Order No. 6.000.402

② Pedal mini/ plastic
Order No. 6.000.403

③ Benchtop switch / stainless steel
Order No. 6.000.405

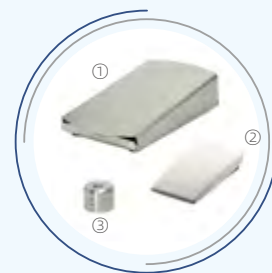

Tray, right or left side, stainless steel
Order No. 8.000.340

triangle spatula / glass
Order No. 6.000.370

triangle spatula / stainless steel
Order No. 6.000.369



Inoculation loop holder
stainless steel, with sleeve nut, for
inoculation loops wire Ø 0.6 - 1 mm

length 245 mm
Order No. 6.000.360

length 215 mm
Order No. 6.000.365



Turntable
extra wide for Petri dishes up to 150 mm
with transparent silicone covering
Order No. 7.000.150





Shaker

Orbital Shaker

- > Two different shaking functions: reciprocal, and orbital
- > Adjustable shaking speed and range
- > Timer function for maximum flexibility
- > Corrosion-resistant power-coated stainless steel housing
- > Easy to clean and maintain
- > Large mounting surface and big load capacity of up to 12 kg
- > Suitable for various vessels, like round flasks, Erlenmeyer flasks, culture flasks, or culture bottles
- > Widely used for bacterial cultures, fermentation, hybridization, biochemical reactions, enzyme or tissue research
- > Shaking motion can be set in up to 6 different ways
- > Wide range of accessories are available.

The distinctive and economical models offer the most felicitous shaking motion

Two types of shaking motions (orbital or reciprocal). Three types of orbital or reciprocal lengths. The compact and interchangeable platform design accommodates various types and sizes of vessels and suitable for use in chambers.

Specifications

Model	WS-50D	WS-50DR
Motion Type	Orbital	Reciprocal
Speed Range (Rpm)	10 to 300	10 to 250
Accuracy (rpm)	±2 (100 Rpm)	±2 (100 Rpm)
Timer (min)	Forward & Backward: 1min to 999min	Forward & Backward: 1min to 999min
Shaking Throw (mm)	20 (10 to 300rpm/14mm; 10 to 300rpm/8mm Available)	20 (10 to 300rpm/14mm; 10 to 300rpm/8mm Available)
Maximum Load (kg)	7	7
Power (W)	80	80
Platform (W×D) (mm)	320x260(mm)	320x260(mm)
Overall (W×D×H) (mm)	355x375x140(mm)	355x375x140(mm)
Weight(kg)	20	20
Order No.	3A126C	3A226C



Multi-function Shaking System

Intensive multi-function shaking system surpasses all the previous levels of shaker units. Mix and match clockwise, counterclockwise, start, and stop motions.

(Making 6 possible combinations - refer to each model spec.)

Dual-Action Shakers

Benchtop platform shakers with advanced dual-shaking features, for flasks up to maximum 6L.

Performances: Orbital or reciprocal action and variable-speed control provide gentle to vigorous agitation. It offers user-friendly operating and safety features for reliable shaking of lab glassware.



Note:

Mounting plate not included



Specifications

Model	WS-100D	WS-150D	WS-200D
Display and Control	TFT Digital Display / On-Touch Control	TFT Digital Display / On-Touch Control	TFT Digital Display / On-Touch Control
Motion Type	Orbital or reciprocal motion selectable	Orbital or reciprocal motion selectable	Orbital or reciprocal motion selectable
Accuracy(rpm)	±1 (100rpm)	±1 (100rpm)	±1 (100rpm)
Speed Range (Rpm)	10~300	10~300	10~300
Shaking Throw (mm)	20, 30, 40 Available - Standard 30	20, 30, 40 Available - Standard 30	30, 40, 50, 60, 70 Available - Standard 30
Timer (min)	Run time: 1min to 999min, Forward & Backward, Pause : 1min to 999min		
Maximum Load (kg)	7	15	30
Power (W)	100	110	130
Platform (W×D) (mm)	350×350	450×450	755×481
Overall (W×D×H) (mm)	410×490×150	510×595×150	820×610×166
Weight (Kg)	24	29	50
Order No.	200200C	200300C	200400C

Accessories for Shaker



Sticky Plate

The Wiggins Sticky Plate can be loaded with any kind of vessels with a smooth base. Even at a speed of up to 350 rpm the vessel sticks to the plate. Other vessels, like microtitre plates can be shaken on the Wiggins Sticky Plate as well. but, only up to a speed of 220 rpm.

Suitable for	WS-50D/50DR	WS-100D	WS-150D	WS-200D
Order No.	3A901	31901	31902	31903
Dimensions(W x D in mm)	320x260	350x350	450x450	755x481



Multi-Purpose Spring

The multi-purpose tray is made of stainless steel and can be used for a diverse range of unusual specifications.

Suitable for	WS-50D/50DR	WS-100D	WS-150D	WS-200D
Order No.	3A521	31521	31522	31523-W
Max. Load of Flasks				
50ml	12	16	25	40
100ml	6	9	16	28
250ml	3	4	9	15
300ml	3	4	9	15
500ml	3	4	5	10
1L	2	2	4	8
2L	-	1	2	4
2.8L	-	1	2	4



Adjustable Bar Tray

Suitable for	WS-50D/50DR	WS-100D	WS-150D	WS-200D
Order No.	3A511	31511	31512	31513
Number of bar	3	3	3	6
Order No. of bar	3A511-05	31511-05	31512-05	31513-05

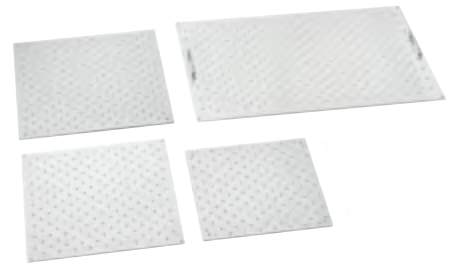

Universal Trays

The Universal Trays have a drilled grid for individual loadings of test tube holders with clamps, molds for microtitre plates, and deep-well plates.

Suitable for	WS-50D/50DR	WS-100D	WS-150D	WS-200D
Order No.	3A501	31501	31502	31503
Dimensions(W x D in mm)	320x260	350x350	450x450	755x481

Max. Load of Flask Clamps

50ml	20	32	49	96
100ml	9	25	36	65
250ml	9	13	25	40
300ml	6	13	25	40
500ml	4	9	13	24
1L	2	4	8	12
2L	1	2	5	11
4L	-	2	2	4

Max. Load of Separatory Funnel Clamps

250ml	4	4	6	11
500ml	3	3	4	9
1L	2	2	3	5
2L	-	1	2	4



Erlenmeyer flask clamps

Size of flask	Reference No.	Order No.
25mL	31274	-
50mL	31279	23550
100mL	31271	23551
250mL	31275	23552
300mL	-	23556
500mL	31280	23553
1000mL	31272	23554
2000mL	31273	23555
2800mL Fernbach	-	23557
3000mL	31277	-
4000mL	31278	23558
5000mL	31281	-
6000mL	-	23559



Separatory Funnel Clamps

Funnel Volumes	250mL	500mL	1L	2L
Order No.	23562	23563	23564	23565

Multi-Pore Holders

The Wiggins multi-pore holders can be installed on the Wiggins sticky plates or the Wiggins universal trays. All holders can be installed on small pores and deeper holes. In total, four different multi-pore holders are available:

1. Multi-Layer Holder
2. Single-Layer Single-Position Holder
3. Single-Layer Three-Position Holder
4. Single-Layer Four-Position Holder



Max. No. of Mountable Holders	Multi-Layer	Four-Position	Three-Position	Single-Position
Order No.	23651	23652	23653	23654
Max. mountable holders				
WS-50D/50DR	4	-	1	6
WS-100D	6	-	2	8
WS-150D	10	2	3	15
WS-200D	16	3	5	25



Rubber Mats

Designed for low-speed applications, non-skid rubber mats allow quick addition or removal of flasks, plates or tubes.

Suitable for	WS-50D/50DR	WS-100D	WS-150D	WS-200D
Order No.	3A531	31531	31532	31533

Plastic clamps for Erlenmeyer flask

Order No.	Description	Order No.	Description
31285	100ml	31287	500ml
31286	250ml		

Stainless steel clamps for Fernbach flask

Order No.	Description	Order No.	Description
31283	1.8L	31284	2.8L



Test tube rack for long type

Order No.	Description	Order No.	Description
31342	144 x Ø8mm	31356	39 x Ø18mm
31343	100 x Ø10mm	31358	36 x Ø20mm
31347	72 x Ø12mm	31359	33 x Ø22mm
31352	64 x Ø14mm	31360	20 x Ø25mm
31354	36 x Ø16mm	31361	16 x Ø30mm

Test tube rack for short type

Order No.	Description
31348	72 x Ø12mm
31353	64 x Ø14mm
31357	39 x Ø18mm (Suitable for Greiner Bio-one tube)

Rack for plastic test tube

Order No.	Description
31355	36x Ø16mm (15ml)
31362	16x Ø30mm (50ml)

187mm test tube rack for short type

Order No.	Description	Order No.	Description
31344	44 x Ø12mm	31349	21 x Ø20mm
31346	24 x Ø18mm		

Shaker for CO₂ Incubator

This is Compact Shaker with benefits such as small foot print and easy to move. Built-in Plate Type BLDC motor provides low noise, low vibration. Despite compact size, shaking is powerful and the workplace is large to load various vessels.



Specification

Model	SRC	CRC	MRC
Motion		Orbital	
Control		Microprocessor Digital	
Motor		Plate BLDC motor	
Drive System		Direct Magnetic Drive	
Display		LED display	
Speed Range (rpm)	30 ~ 300	30 ~ 300	30 ~ 300
Accuracy (rpm)	±1	±1	±1
Shaking Throw (mm)	25	25	25
Time Range		Continuous or up to 99 hours 59min	
Time Increment		1min	
Shaker size(W x L x H mm)	300 x 345 x 90	450 x 390 x 120	465 x 520 x 130
Weight (Kg)	7.5	14	25
Platform Size(W x L mm)	300 x 330	440x370	455 x 455
Control box Size(W x L x H mm)		155 x 95 x 25 / 0.5	
Power		100-240V 50/60HZ	
Load Capacity	100mL x 16	100ml x 23	100mL x 36
	250mL x 9	250ml x 10	250mL x 23
	500mL x 5	500ml x 6	500mL x 16
	1000mL x 4	1000ml x 5	1000mL x 9
	2000mL x 1	2000ml x 2	2000mL x 4
Order No.	W6100100	W6100200	W6100300

Features

Gentle magnetic drive

The non-belt magnetic drive design affords for high performance of water resistance. This most gentle drive unit has exceptionally smooth start-up and braking behavior, and is specifically good for cell cultures.

Made of stainless steel

The entire housing of shaker is made of stainless steel (SUS304), meeting the demand of GMP's cleaning requirements. It is easy for the removal of any unwanted liquids and can be cleaned with chemicals.

Magnetic Attachment

The thin Wire Cable connection between the shaker and the control box can pass through the sealing part of the inner glass door although no access port is in your incubator.

Placing remote box with Magnet

Depending on the material type of the incubator or the situation of the lab, placing remote box is available with integrated magnets.

Accessories

Order No.	Name
Suitable for SRC	
W6100101	Sticky Plate
W6100102	Universal Tray
W6100103	Multi-Purpose Tray
W6100104	Microplate Rack
Suitable for CRC	
W6100201	Sticky Plate
W6100202	Universal Tray
W6100203	Multi-Purpose Tray
W6100204	Microplate Rack
Suitable for MRC	
W6100301	Sticky Plate
W6100302	Universal Tray
W6100303	Multi-Purpose Tray
W6100304	Microplate Rack



Sticky Plate



Universal Tray



Multi-Purpose Tray



Microplate Rack

Microplate Rack

Rocking Shaker

Simple Adjustments for Rocking Speed

WIGGENS Rocking Shaker is innovatively designed for use in a wide range of lab applications. WS-350R provides controlled seesaw-like motion, while the Shakers offer a smooth, low-foaming, 3D wave motion. Each unit includes a dimpled mat and universal harness

It can be used in the incubator because the unit is designed for ambient temperature between 2 °C and 50°C

Your advantages

- > Working speeds range from 5rpm to 100rpm
- > Bright TFT with display resolution 1rpm, easy to operate with the knob and control keys
- > Tilt Angle ranges from 7° to 13°
- > Smooth Starting function to protect sample spilling out
- > Users can set the timer from 1 min to 99 hour 59 min, with the count-down timer.
- > BLDC motor provides low noise and strong durability
- > During overload situation, it shows overload sign, make alarm and stop the running



Application

Mixing blood samples, DNA extractions, blotting techniques, staining and destaining gels, hybridizations

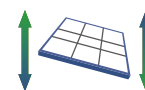

Specifications

Model	WS-350R	
Shaking System	Speed range(rpm)	5~ 100
	Speed control type	Feedback Control
	Tilt Angle	Easy adjustable from 7° to 13°
	Timer	1min to 99 hrs 59 min, Count-down time
Safety device	Over current protection	
Max. Load including attachment (kg)	5	
Motor type	BLDC motor	
Control panel	TFT, touch keys and the control knob	
Dimension	Overall Dimension (W×D×H, mm)	276 x 343 x 150
	Tray dimension (W x D, mm)	276x 276
	Net Weight (kg)	6.9
Materials	PP, PET, Powder coated steel (Housing)	
Electrical requirement	100 ~ 240VAC, 50 / 60 Hz	
Order No.	W5011001	

Accessories

Order No.	Part	Description
W5011101	Removable tray (Standard)	Included tray, silicon mate and universal harness (6ea)
W5011102	Removable tray	Included tray, rubber mat and universal harness (6ea)
W5011201	Tray	Tray only
W5011202	Rubber mat	Rubber mat
W5011203	Dimpled mat	Dimpled mat
W5011204	Universal harness, 6ea	Universal harness, 6ea

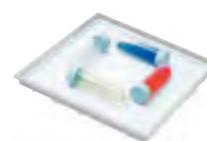

W5011101



W5011102

Waving Shaker

Simple Adjustments for Tilt Angle and Speed

WIGGENS Waving Shaker is innovatively designed for use in a wide range of lab applications. WS-350W provides controlled orbital motion, while the Shakers offer a smooth, low-foaming, 3D wave motion. Each unit includes a dimpled mat and universal harness. It can be used in the incubator because the unit is designed for ambient temperature between 2 °C and 50°C.

Your advantages

- > Working speeds range from 8rpm to 100rpm
- > Bright TFT with display resolution 1rpm, easy to operate with the knob and control keys
- > Tilt Angle ranges from 0° to 13°
- > Smooth starting function to protect sample from spilling out
- > Users can set the timer from 1 min to 99 hour 59 min, with the count-down timer.
- > BLDC motor provides low noise and strong durability
- > During overload situation, it shows overload sign, make alarm and stop the running



Application

Mixing blood samples, DNA extractions, blotting techniques, staining and destaining gels, hybridizations



Specifications

Model		WS-350W
Shaking System	Speed range(rpm)	8~ 100
	Speed control type	Feedback Control
	Tilt Angle	Easy adjustable from 0° to 13°
	Timer	1min to 99 hrs 59 min, Count-down time
Safety device	Over current protection	
Max. Load including attachment (kg)	5	
Motor type	BLDC motor	
Control panel	TFT, touch keys and the control knob	
Dimension	Overall Dimension (W×D×H, mm)	276 x 343 x 150
	Tray dimension (W x D, mm)	276x 276
	Net Weight (kg)	7.3
Materials	PP, PET, Powder coated steel (Housing)	
Electrical requirement	100 ~ 240VAC, 50 / 60 Hz	
Order No.	W5011002	

Accessories

Order No.	Part	Description
W5011101	Removable tray (Standard)	Included tray, silicon mat and universal harness (6ea)
W5011102	Removable tray	Included tray, rubber mat and universal harness (6ea)
W5011201	Tray	Tray only
W5011202	Rubber mat	Rubber mat
W5011203	Dimpled mat	Dimpled mat
W5011204	Universal harness, 6ea	Universal harness, 6ea

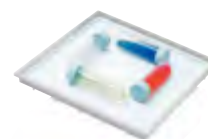

W5011101



W5011102

Microplate Shaker

Suitable for Microplate, Micro-tube and Conical tube

The microplate shaker is driven by brushless DC motor. It is mainly used in the mixed oscillation of enzyme label plate (96-well / 384-well plate), cell culture plate (24-well plate, 48-well plate, 96-well plate), micro tube and conical tube. It can be used in immunoassays, staining and other experiments. It has compact design and ensures, simple and convenient operation, safety, stability and no noise.

Your advantages

- > Working speeds range from 150rpm to 1200rpm
- > Bright TFT with display resolution 1rpm, easy to operate with the knob and control keys
- > Rotational motion with shaking radius of 3mm
- > Smooth starting function to protect the sample from spilling out
- > Users can set the timer from 1 min to 99 hour 59 min, with the count-down timer.
- > Possible to use 1.5ml Micro-tube, 15ml, 50ml conical tube.
- > BLDC motor provides low noise and strong durability
- > During overload situation, it shows overload sign, make alarm and stop the running



Specifications

Model		WS-350P
Shaking System	Speed range(rpm)	150~1,200 (No-load running)*
	Speed control type	Feedback Control
	Orbital diameter (mm)	3
	Timer	1min to 99 hrs 59 min, Count-down time
Safety device	Over current protection	
Max. Load including attachment (kg)	4	
Motor type	BLDC motor	
Control panel	TFT, touch keys and the control knob	
Dimension	Overall Dimension (W×D×H, mm)	249 x 329 x 127
	Tray dimension (W x D, mm)	267x 183
	Net Weight (kg)	10.3
Materials	PP, PET, Powder coated steel (Housing)	
Electrical requirement	100 ~ 240VAC, 50 / 60 Hz	
Order No.	W5011003	

* Maximum speed at full load is 925 Rpm

Accessories

Order No.	Part	Description
W5011301	Micro-tube rack	1.5ml Micro-tube rack
W5011302	Micro-tube rack	15ml Micro-tube rack
W5011303	Micro-tube rack	50ml Micro-tube rack

Heating Shaker

Useful for a variety of molecular biology applications.

Interval mix function in program mode can be properly set according to users' test condition.

Features

- > Microprocessor PID control ensuring consistent shaking motion and precision accuracy.
- > Speed range from 150 to max. of 1500 rpm (depending on the choice of interchangeable blocks)
- > Maximum 9 temperature range-specific calibration.
- > Memory function of programmed protocols allowing relevant parameters (such as temp., rpm, time) of each protocol step to be stored.
 - Up to 10 protocols allowed for memory storage.
 - Up to 10 steps allowed for each protocol.
 - Interval Mix function (continuous switching between shaking and phasing)
- > Two types of timer modes:
 - Timer 1 starts only after reaching the set temp.
 - Timer 2 starts right after the timer setting.



- > 96-Well Tube Block Set with Covers
- > 0.5mL / 1.5mL / 50mL Tube Block Set with Covers



Specifications

Mode		WS-350B	
Order No.	W5012350		
Control	Feedback control PID		
Display	VFD (0.1°C resolution)		
Temperature	Range (°C)	Amb.+5-100°C	
	Fluctuation at 80°C (±°C)	0.3	
	Variation at 80°C (±°C)	0.7	
	Heating power (W)	360	
Safety	OverTemp.	Heating plate	
	Over Current	Current limit protection	
	Motion Type	Orbital	
Shaking System Dimension (WxDxH)	Speed range (rpm)	96-well tube block	150 -1500
		0.5mL tube block	150- 1000
		1.5 mL tube block	150-1000
		50 mL tube block	150-800
	Orbit Size (mm)	2	
Overall(WxDxH) (mm)	276 x 334 x 170		
Weight (kg)	8.3		
Electrical requirements	230V, 50 / 60 Hz, 1.7A		

Constructional

- > Bright VFD display with responsive touch buttons.
- > Its powder coated stainless steel body is highly chemical-resistant and easy-to-clean.
- > Optimal heat transfer is achieved by the tight coupling design of the main body and the corrosion-resistant anodized aluminum blocks.
- > Low-profile design with rubber feet for minimal vibration and noise.
- > Blocks can be easily interchanged by the included block lifter.

Accessories

Order No.	Description	Max. Mountable Tube
W5012451	0.5 mL Tube Block Set with Cover	0.5mL x 48 holes (microtube)
W5012452	1.5 mL Tube Block Set with Cover	1.5mL x 24 holes (microtube)
W5012453	50 mL Tube Block Set with Cover	50mL x 6 holes (centrifuge tube)
W5012454	96-well Tube Block Set with Cover	0.2mL x 96 holes (microtube)



Vortex Shaker -Vortex3000 Elite

Low profile design and highly touch sensitive sensor reduce wrist stress when pushing and holding experiment tools resulting in less fatigue and unpleasant feeling.

Features

- > Elaborate design for safe and reliable vortex shaking
- > Variable speed is from 100 to 3000 rpm
- > Very suitable for work in fume hoods and on sterile workbenches
- > Excellent vortex mixing of test tubes and cap vials
- > Shaking operation can be switched between continuous and on-touch operation
- > Two modes of time: 1s–99min59s and 1min–99hr59min
- > Countdown in timer mode allows to calculate the experiment time.
- > LED light shows set mixing speed.
- > Rubber feet guarantee stability of the shaker
- > Power cut-off function in case of electrical overload or excess current.
- > Chemically resistant PP (polypropylene) housing.
- > A wide range of accessories available (the rubber platform comes standard).



Specifications

Mode	Vortex3000 Elite
Order No.	W3060215
Motion	Orbital
Shaking throw (mm / inch, Ø)	4/1.6
Operation mode	Touch/Continuous
Timer	Yes
Interface	RS232, USB (B)
Display	Dual LED
Operation panel	Glass
Control mode	Knob/Button
Speed range (rpm)	100-3000
Speed increment (rpm)	10
Speed resolution (rpm)	1
Time increment (min/s)	1
Time (min/s)	1
Time range	1s-99min:59s or 1min-99hr:59min
Power (V)	DC24V, 0.75A
Dimension (WxDxH/mm):	147x173x92
Output (W)	15
Net weight	2.8kg

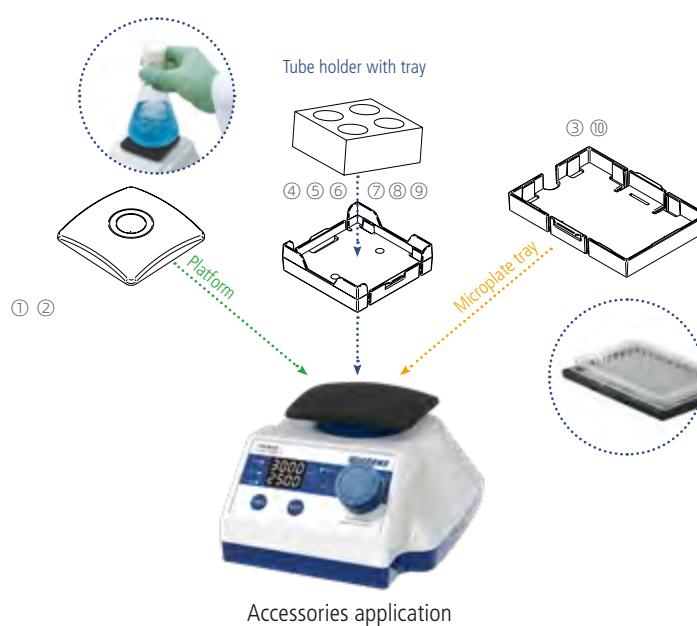

Vortex Shaker

Low profile design and touch sensitive sensor reduce wrist stress when pushing and holding experiment tools resulting in less fatigue and unpleasant feeling.

Features

- > Elaborate design for safe and reliable vortex shaking
- > Speed can be set between 0 and 3000 rpm (Scale)
- > Suitable for work under fume hoods, and on sterile workbenches
- > Excellent vortex mixing of test tubes and capped vials
- > Shaking operation can be switched between continuous and on-touch operation
- > LED light shows the actual shaking operation method
- > Rubber feet guarantee stability of the shaker
- > Power cut-off function in case of electrical overload or excess current.
- > Chemically resistant PP (polypropylene) molded exterior.
- > A wide range of accessories available.(the rubber platform comes standard)

Specifications

Model	Vortex3000		
Technical Data	Motion	Orbital	
	Speed Range (Rpm)	0 - 3,000 (Turning knob scale display)	
	Control	Scale	
	Shaking Throw (mm / inch, Ø)	4 / 0.16	
	Operating Mode	Touch, Continuous	
	Motor Rating Input / Output (W)	12W / 6W	
	Motor	BLDC motor	
	Max. Load (kg / lbs) - incl. attachment	0.5 / 1.1	
	General Data	Material	Body Polypropylene Platform Silicone rubber
		Dimension (mm / inch, W×D×H)*	148×159×77 / 5.8×7.4×3
Net Weight (kg / lbs)		2.6 / 5.7	
Safety Device		Current limit protection	
Protection Class (DIN EN 60529)	IP 42		
Order No.	360115		



Best-seller!



Accessories for Vortex 3000 Series

No.	Order No.	Description
1	V0058	Platform (pop-off)
2	V0011	Platform
3	V0008	Microplate tray, Speed range recommendation 0-1500rpm
4	36520	Tube holder with tray (up to Ø50mm), Speed range recommendation 0-1500rpm
5	36521	Tube holder with tray (Ø10mm x 16 ea), Speed range recommendation 0-1500rpm
6	36522	Tube holder with tray (Ø12mm x 9 ea), Speed range recommendation 0-1500rpm
7	36523	Tube holder with tray (Ø15mm x 9 ea), Speed range recommendation 0-1500rpm
8	36524	Tube holder with tray (Ø20mm x 5 ea), Speed range recommendation 0-1500rpm
9	36525	Tube holder with tray (Ø25mm x 4 ea), Speed range recommendation 0-1500rpm
10	36526	Tube holder with tray (Ø8mm x 18 ea & Ø10mm x 28 ea), Speed range recommendation 0-1500rpm

TM Series Vortex Shaker

- > Very accurate shaking speed due to the micro-chip speed controller
- > Stable and reliable performance
- > High shaking speed of up to 2500 rpm
- > Shaking operation can be switched between continuous and on-touch operation
- > Suitable for shaking test tubes or other small volume vials
- > Large range of platforms and other accessories
- > Aluminum housing
- > Suitable for deep well titer plates
- > Can be used as a stirrer and flask shaker when choosing the right accessories.



TM-1



TM-1F

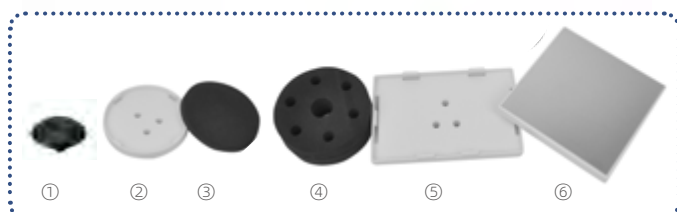

TM-1F / 2F Accessories

TM-1F/2F 6 in 1 Package



Platform (standard) ①



One-hand insert ③
Order No.: 3601-06
Universal Tray ②
Order No.: 3601-01



Test Tube Platform (6 Holes) ④
Order No.: 3601-04
Universal Tray ②
Order No.: 3601-01



Elisa Plate Tray ⑤
Order No.: 3601-03



Magnetic Stirring Plate ⑥
Stirring Speed 0~1500rpm
Order No.: 3601-02

TM-1F / 2F

Specifications

Model	TM-1	TM-1F	TM-2	TM-2F
Shaking Speed(rpm)	0-2500	0-2500	0-2500	0-2500
Max. Volume (L) in Stirring Mode	2	2	2	2
Housing Material	Plastic-Aluminum	Plastic-Aluminum	Plastic-Aluminum	Plastic-Aluminum
Shaking Throw (mm)	4.5	4.5	4.5	4.5
Speed Control/Display	Turning Knob Scale Display	Turning Knob Scale Display	Turning Knob LED Display	Turning Knob LED Display
Operation Mode	Continuous / On-Touch	Continuous / On-Touch	Continuous / On-Touch	Continuous / On-Touch
Accessories	Shaker Tray	Accessory Pack	Shaker Tray	Accessory Pack
Power (W)	17.3	17.3	17.3	17.3
Dimension (mm)	115X230X60	115X230X60	115X230X60	115X230X60
Order No.	360110	36011F	360120	36012F

Accessories for TM Series



Universal Tray

Can be used with different foam plastic platforms for simultaneous shaking of several test tubes
Order No. : 3601-01



Magnetic Stirring Plate

Can be directly installed on the shaker and used for stirring of smaller samples
Stirring speed: 0-1500rpm
Order No. : 3601-02



Elisa Plate Tray

Can be used with an ELISA Plate
Speed range recommendation: 0-1500rpm
Order No. : 3601-03



Test Tube Platform (6 Holes)

Can be used in combination with the universal tray for shaking operation of 6 test tubes with 12 mm diameter
Speed range recommendation: 0-2000rpm
Order No. : 3601-04



Test Tube Platform (4 Holes)

Can be used in combination with the universal tray for shaking operation of 4 test tubes with 16 mm diameter
Speed range recommendation: 0-2000rpm
Order No. : 3601-05



One-hand insert

80mm
Speed range recommendation: 0-800rpm
Order No. : 3601-06



Universal Base Plate

Base plate for foam plastic platforms with 120 mm diameter
Speed range recommendation: 0-1500rpm
Order No. : 3602-01



Test Tube Platform (54 Holes)

Can be used in combination with the universal base plate for shaking operation of 54 Eppendorf tubes
Speed range recommendation: 0-1500rpm
Order No. : 3602-02



Test Tube Platform (18 Holes)

Can be used in combination with the universal base plate for shaking operation of 18 test tubes with 10 mm diameter
Speed range recommendation: 0-1500rpm
Order No. : 3602-03



Test Tube Platform (12 Holes)

Can be used in combination with the universal base plate for shaking operation of 12 test tubes with 12 mm diameter
Speed range recommendation: 0-1500rpm
Order No. : 3602-04



Test Tube Platform (8 Holes)

Can be used in combination with the universal base plate for shaking operation of 8 test tubes with 20 mm diameter
Speed range recommendation: 0-1500rpm
Order No. : 3602-05



Test Tube Platform (8 Holes)

Can be used in combination with the universal base plate for shaking operation of 8 test tubes with 20 mm diameter
Speed range recommendation: 0-1500rpm
Order No. : 3602-06



Flask Holder

Can be used in combination with the universal base plate for shaking operation of Erlenmeyer or round flasks with a volume between 100 and 250 ml
Order No. : 3602-07



Digital Pulse Mixer

Performing high or low speed pulse vortexing/mixing for most applications

WIGGENS Digital Pulse Mixer is capable of performing high or low speed pulse vortexing/mixing for most applications. This unit is able to accommodate a wide variety of glassware, racks, well plates or reactor blocks for accurate, repeatable results. The microprocessor-based control technology allows for display of speed, multi-function timer, and pulse profiling.



Your advantages

- > Working speed range from 100rpm to 1500rpm
- > Bright TFT with display resolution 1rpm, easy to operate
- > Built-in digital timer (seconds: 1-60, minutes 1-60, hours 1-24)
- > Preset run times of 30, 60, 90 and 120 seconds
- > User selectable pulse profile (Pulses-per-minute: 1-100), Ppm-duty-cycle: 1-99 %
- > Timer and Pulse mode may be combined for timed-pulse mode
- > Fail Safe Mode to prevent speed fluctuations
- > BLDC motor provides low noise and strong durability
- > User-friendly operating panel (4 buttons)
- > Smooth Starting function to protect the sample from spilling out
- > RS232 interface, optional software for real time data acquisition

Application

Solution phase synthesis, solid phase chemistry, bacteria cultivation



Specifications

Model	DPM-24
Order No.	W5021001
Working speed range(rpm)	100 ~1500
Speed control type	Feedback Control
Control panel	TFT, Push button
Motor type	BLDC motor
Quick timing mode	30s, 60s, 90s, 120s are available
Pulse mode	Pulses adjustment range(min): 1-100 Duty Cycle adjustment range(%): 1-100
Timer and Pulse mode	Timer: 00:00:00 to 24:60:60 Pulses adjustment range(min): 1-100 Duty Cycle adjustment range(%): 1-100
Electrical requirement	110 or 240VAC, 50 / 60 Hz

Sample Preparation

Our Digital Pulse Mixers are ideal for preparation work in volumetric flasks.

Simply changing the chemical resistant bottom foam pad allows you to quickly switch flask sizes while using one standard hold down top.

Order No.	Description
W5021101	Hold down top with holes
W5021102	15mm pad for 25ml vol. flask, 49 Position
W5021103	15mm pad for 50ml vol. flask, 14 Position
W5021104	15mm pad for 100ml vol. flask, 14 Position
W5021105	15mm pad for 250ml vol. flask, 8 Position
W5021106	15mm pad for 500ml vol. flask, 6 Position



25mL Vol. Flasks



50mL Vol. Flasks



100mL Vol. Flasks



250mL Vol. Flasks



500mL Vol. Flasks

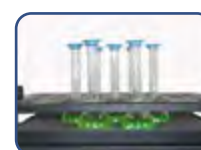

Digital Pulse Mixer Shown with 100ml Volumetric Flasks & Hold Down Top

Cell Culture Roller Rack

WIGGENS cell culture roller rack Celrol Mini and Celrol Mid is highly flexible in facilitating its operation not only inside the incubator but also elsewhere on the work table. Remote control box can be attached to the incubator surface and flat cable needs no particular measures such as the access port. Its operation capacity is 2000ml bottle x 4ea (Mini) and 2000ml bottle x 6ea (Mid) at one time. The speed range is 0.2rpm to 8.1 rpm to help users utilize adherent cell culture performance.

Features

- > Steel reinforced polyurethane timing belts
- > Brushless DC Motor
- > Powder coated aluminum for durability and cleanliness
- > Non-slip rubber material for the best performance of rolling
- > Designed for no idle roller by drive-belt



Specifications

Model	Celrol Mini	Celrol Mid
Rpm Range	0.2~8.1rpm	0.2~8.1rpm
Accuracy	1rpm	1rpm
Increment	0.1rpm	0.1rpm
Control	Microprocessor digital PID	Microprocessor digital PID
Time Range	Continuous or up to 999h 59min	Continuous or up to 999h 59min
Accuracy	±1%	±1%
Display	LED Display	LED Display
Motor type	Brushless DC motor	Brushless DC motor
Standard roller bottle	110mm to 120mm, 4ea	110mm to 120mm, 6ea
Roller deck dimension	362 (W) ×299 (D) ×212 (H) mm	362 (W) ×299 (D) ×412 (H) mm
Overall dimension	375 (W) ×370 (D) ×345 (H) mm	375 (W) ×370 (D) ×545 (H) mm
Power	AC 90~264V, 50/60Hz, 10W	AC 90~264V, 50/60Hz, 10W
Weight	12.5kg	13.5kg
Order No.	W6110100	W6110200



Can contain four Dia.100-120mm roller bottles.

Outside control

Controller can adjust speed without opening the door.

Roller Apparatus

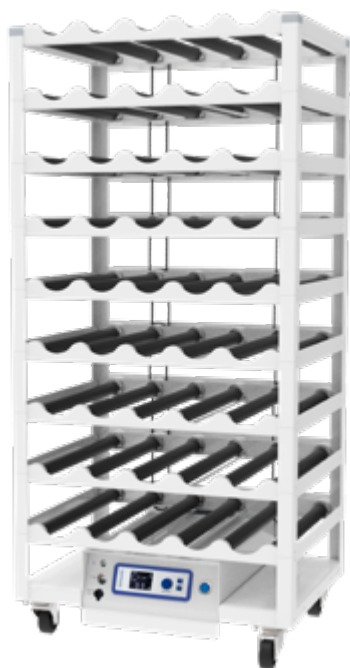

Celrol Pro

- > Smooth ramping digitally controlled rotation accurate to 0.01 Rpm
- > Maintenance-free precision brushless motor
- > Bright TFT display for easy operation
- > SMS alarm function
- > Can Be directly connected to the printer

Specifications

Model	Celrol Pro
Display	TFT
Capacity	5~55 Positions
Bottle Speed (110mm Bottle)	0.08~2.5rpm
Diameter of roller bottles	108~121mm
Length of roller bottles	Max. 550mm
Accuracy	0.01rpm
Drive	Belt Driven
Motor Type	Brushless DC
Rotation Direction	Clockwise and Counter-Clockwise
Options	Temperature Alarm and Battery Backup
Remote Communication	RS232
Humidity	80% up to 37°C
Operating Temperature	10 to 40°C
Electrical	100-240 VAC, 50/60 Hz

Celrol Elite

- > Robust touch screen interface that is easy to view from a distance
- > Readily recognizable icons for intuitive navigation
- > Digitally controlled maintenance-free motor accurate to 0.01 Rpm
- > RS-422 Modbus RTU, RS-4485 Modbus RTU, Modbus TCP and TCP/IP
- > SMS alarm function
- > Can Be directly connected to the printer

Specifications

Model	Celrol Elite
Display	SIMATIC HMI Touch Screen
Capacity	8~88 Positions 5~55 Positions
Bottle Speed (110mm Bottle)	0.08~2.5rpm
Diameter of roller bottles	108~121mm
Length of roller bottles	Max. 550mm
Accuracy	0.01rpm
Drive	Belt Driven
Motor Type	Brushless DC
Rotation Direction	Clockwise and Counter-Clockwise
Options	Temperature Alarm and Battery Backup
Remote Communication	RS-422 Modbus RTU, RS-4485 Modbus RTU, Modbus TCP and TCP/IP
Humidity	80% up to 37°C
Operating Temperature	10 to 40°C
Electrical	100-240 VAC, 50/60 Hz

Separatory Funnel Shaker

WS-1

Intensive vertical reciprocal quick solvent extraction shaking unit.

The separatory funnel shaker is able to shake six samples under identical conditions for any series or comparative protocols in chemistry, biotech, and medical labs.



WS-1
Angle is not adjustable

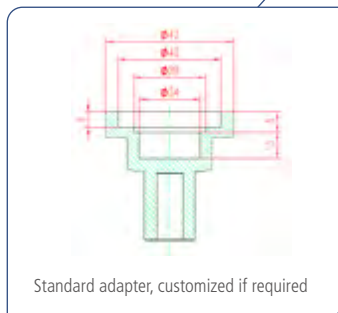

WS-1PLUS
0~20° Angle adjustable

Features

- > Intensive vertical shaking
- > Shaking of 6 samples under identical conditions possible
- > Mostly used in chemical, biotech, and medical laboratories
- > The speed can be set between 50 and 300 rpm
- > The timer can either be set on continuous or between 0 and 60 min
- > Flasks of up to 40 mm width can be used
- > Bright TFT display for convenient speed monitoring
- > Wide speed range and high precision of the speed control
- > Feedback loop to a digital controller
- > At the end of a shaking session the device stops automatically with an audible alarm
- > Easily adjustable flask holder (max. 5 flasks per side)
- > Two holders for a total of 6 flasks (1000ml) included
- > WS-1 PLUS entails a flask holder to adjust the shaking angle

* Funnel Capacities (per each side)

Capacity	Round type funnel	Slim type funnel
under 500ml	3-5	5
500ml	3	3
1L	--	3
2L	--	2

Accessories Included

- 500mL Separatory Funnel Holder (Order No.: 32500)
- 1L Separatory Funnel Holder (Order No.: 32501)
- 2L Separatory Funnel Holder (Order No.: 32502)

Specifications

Model	WS-1	WS-1 PLUS
Motion Type	Vertical reciprocal	
Speed Range (rpm)	50 ~ 300	
Accuracy(± rpm)	± 1	
Vertical Stroke Length (mm)	40	
Timer	60 min or continuous operation	
Overall (W×D×H) (mm)	445×730×505	
Max. Load per each Side (kg)	3	
Power (W)	90	
Fixture	6	
Weight (Kg)	77	90
Order No.	32012KA	32012KB

Funnel Separatory, Glass or PTFE stopper

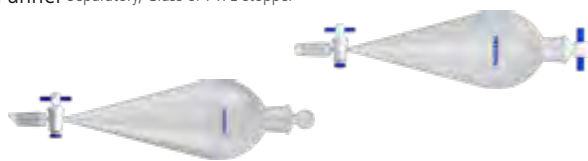

Order No.	Capacity (mL)	Joint	Plug Bore (mm)	Stopper
189111-05	50	14/20	2	PTFE stopper
189111-06	50	19/22	2	PTFE stopper
189111-07	100	14/20	2	PTFE stopper
189111-08	100	19/22	2	PTFE stopper
189111-09	125	14/20	2	PTFE stopper
189111-10	125	19/22	2	PTFE stopper
189111-11	125	24/40	2	PTFE stopper
189111-12	250	14/20	4	PTFE stopper
189111-13	250	19/22	4	PTFE stopper
189111-14	250	24/40	4	PTFE stopper

Order No.	Capacity (mL)	Joint	Plug Bore (mm)	Stopper
189111-19	50	14/20	2	Glass stopper
189111-20	50	19/22	2	Glass stopper
189111-21	100	14/20	2	Glass stopper
189111-22	125	14/20	2	Glass stopper
189111-23	100	19/22	2	Glass stopper
189111-24	125	19/22	2	Glass stopper
189111-25	125	24/40	2	Glass stopper
189111-26	250	14/20	4	Glass stopper
189111-27	250	19/22	4	Glass stopper
189111-28	250	24/40	4	Glass stopper

Optional accessories

Order No.	Description
189111-29	2mm PTFE locking stopper
189111-30	4mm PTFE locking stopper
189111-31	14/20 Glass stopper
189111-32	19/22 Glass stopper
189111-33	14/20 PTFE locking stopper
189111-34	19/22 PTFE locking stopper
189111-35	24/40 PTFE locking stopper

Funnel Separatory, Glass locking stopper



Order No.	Capacity (mL)	Stopper Size (mm)	Plug Bore (mm)	Stopper
189112-02	60	16	2	PTFE
189112-03	125	22	2	PTFE
189112-04	250	22	4	PTFE
189112-05	500	27	4	PTFE
189112-06	1000	27	4	PTFE

Optional accessories

Order No.	Description
189112-07	2mm Glass locking stopper
189112-08	4mm Glass locking stopper

Optional accessories

Order No.	Description
189113-49	2mm PTFE locking stopper
189113-50	4mm PTFE locking stopper

Funnel Separatory, PTFE locking stopper

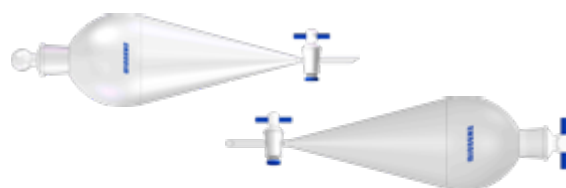

Order No.	Capacity (mL)	Joint	Plug Bore (mm)	Stopper
189113-06	50	14/20	2	Glass stopper
189113-07	50	19/22	2	Glass stopper
189113-08	60	N0.16	2	Glass stopper
189113-09	100	14/20	2	Glass stopper
189113-10	100	19/22	2	Glass stopper
189113-11	125	14/20	2	Glass stopper
189113-12	125	19/22	2	Glass stopper
189113-13	125	24/40	2	Glass stopper
189113-14	125	N0.22	2	Glass stopper
189113-15	250	19/22	4	Glass stopper
189113-16	250	24/40	4	Glass stopper
189113-17	250	29/42	4	Glass stopper
189113-18	250	N0.22	4	Glass stopper
189113-19	500	24/40	4	Glass stopper
189113-20	500	29/42	4	Glass stopper
189113-22	500	N0.27	4	Glass stopper
189113-23	1000	24/40	4	Glass stopper
189113-24	1000	N0.27	4	Glass stopper

Order No.	Capacity (mL)	Joint	Plug Bore (mm)	Stopper
189113-31	50	14/20	2	PTFE stopper
189113-32	50	19/22	2	PTFE stopper
189113-33	60	N0.16	2	PTFE stopper
189113-34	100	14/20	2	PTFE stopper
189113-35	100	19/22	2	PTFE stopper
189113-36	125	14/20	2	PTFE stopper
189113-37	125	19/22	2	PTFE stopper
189113-38	125	24/40	2	PTFE stopper
189113-39	125	N0.22	2	PTFE stopper
189113-40	250	19/22	4	PTFE stopper
189113-41	250	24/40	4	PTFE stopper
189113-42	250	29/42	4	PTFE stopper
189113-43	250	N0.22	4	PTFE stopper
189113-44	500	24/40	4	PTFE stopper
189113-45	500	29/42	4	PTFE stopper
189113-46	500	N0.27	4	PTFE stopper
189113-47	1000	24/40	4	PTFE stopper
189113-48	1000	N0.27	4	PTFE stopper

Pressure Release Valves

These pressure release valves reduce the hazards of pressure build-up. They simply slip over the drain of a WIGGENS funnel and tighten down with a twist of the wrist. The valve can be easily removed when it is time to drain the funnel. Each valve is made of Teflon resin and is factory preset to release at 1 psi of pressure.

The valve can be adjusted to release at pressures up to 5 psi by turning the pressure release slug on the top of the valve with a screwdriver.



Order No.	Description
PRV6	For WIGGENS funnels SEP0060–SEP1000 or spout OD 7.5–9.5 mm
PRV10	For WIGGENS SEP2000 or spout OD 12.5–13.0 mm

Incubator / Oven

Accurate temperature control technology
Compressor cooling system
Peltier cooling system
Internal circulation to ensure temperature uniformity

CO₂ INCUBATOR

RT. +5~60°C / 40 - 120 - 180 - 260 - 650 - 850 - 1200L

PELTIER-COOLED CO₂ INCUBATOR

20~60°C / 40 - 120 - 180 - 260 - 650 - 850L

PORTABLE MINI CO₂ INCUBATOR

+15~45°C / 15L

CO₂ INCUBATOR WITH COPPER CHAMBER

RT. +5~60°C / 180L

TRI-GAS INCUBATOR [N₂ / O₂ / CO₂]

RT. +5~60°C / 40 - 180 - 850L

CONSTANT TEMPERATURE INCUBATOR

RT. +5~60°C / 40 - 100 - 150 - 260 - 650 - 850 - 1200L

LOW TEMPERATURE INCUBATOR

+4~60°C / 150 - 250 - 400L

PELTIER-COOLED INCUBATOR

+4~60°C / 15 - 50L

+15~60°C / 100 - 150L

FORCED CONVECTION OVEN

RT. +10~160°C / 50 - 100 - 150L



CO₂ Incubator

The incubator is ideal for the experiments of the cultivation of animal cells, sperm/ovum, anaerobic cells, all sorts of microbe cells, hatching/germinating and special tissues.

Features

Fast Heat-Up, Fast-Recovery, Stable Control

6 Sides Direct Heating System

Electric heating wire is covered on all sides of the chamber which makes stable uniformity and provides fast heat-up & temperature recovery. 3 parts of heating section are controlled and calibrated individually by 3 temperature sensors.

Dry Wall and Air Jacket

Warm air from heating wire is preserved in space between the chamber and the insulation layer. It helps temperature recover faster and minimize heat loss. Dry wall with insulation requires no regular maintenance.

DUAL BEAM IR CO₂ Sensor

Fast & precise detection for CO₂ gas regardless of temperature and humidity.

Natural Humidification Using Water Tray

The heater on bottom side warms the water in tray and it makes humidification. The circulation fan delivers the moisture formed from the water in the entire chamber.



Specifications

Temp. Range:	RT. +5~60°C
Temp. Resolution:	0.1°C
Dry Heat:	Up to 120°C
Temp. Control:	Digital PID
CO ₂ Range:	0% ~ 20%
CO ₂ Accuracy:	±0.1% (5% / 37°C)
CO ₂ Resolution:	0.1%
CO ₂ Sensor:	IR CO ₂ Sensor
Display:	LED Display
Operating panel:	Individual 2-Channel Touch Button
Jacket type:	Air Jacket Type (6 sides heat)
Chamber material:	Stainless Steel (304)

Model	WCI-40	WCI-120
Order No. Standard	W6011040	W6011120
Order No. Sterilization	W6012040	W6012120
Chamber volume	40L	120L
Temperature Stability [°C]	±0.1°C (37°C)	±0.1°C (37°C)
Temp. Uniformity	±0.3°C (37°C / RT.20°C)	±0.3°C (37°C / RT.20°C)
Heating Capacity [W]	320	320
CO ₂ Inlet pressure range	0.3~0.5bar	0.3~0.5bar
Number of shelves	2/4	3/8
Chamber dimension [WxDxH]	320x350x375mm	480x470x520mm
Overall dimension [WxDxH]	420x460x570mm	580x560x765mm
Weight [kg]	38	72



Alarm System

Buzzer to alarm low or high deviation of CO₂, Temperature.

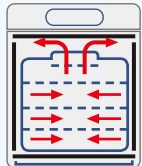

Gentle Air and Moisture Convection

Natural Air and Moisture Convection, Air and Moisture in chamber are distributed gently by 6-side heating and air circulation fan.



Easy to clean

Rounded corner allows easy cleaning. The entire chamber is made of stainless steel (SUS304)



Over Heating Limit

Heating is automatically cut by safety device when temperature control fails or there is excessive heating over set point.



Perforated Shelves

Perforated shelves are good for natural air flows and are made of stainless steel which is resistant to rust and contamination.



No Condensation

Heating by front door heater & frame heater prevents condensation in the chamber and on the glass door.



Microprocessor PID Control

Intelligence Control for CO₂ density, Temperature, Alarm, Automatic Decontamination (Optional).



HEPA filtration of the chamber

Options

Customize your incubator with these options



Access port

25mm Access Port is available at left side. (Upon ordering and additional charge)



UV sterilization

4W UV is placed on the chamber ceiling and beside the circulation fan. The UV light cannot reach sample and sterilization is operated during culturing.



Maximum 125°C dry hot air sterilization
No need to remove IR CO₂ sensor



Monitoring System

Analog connection port has been designed to observe the status of equipments in real time even in the far distance.



lower Gas Consumption. lower Heat loss.
Faster Recovery Easy Classification for Various samples.
5 Split Door for WCI-40
6 Split Door for WCI-180

Model		WCI-180	WCI-260	WCI-650	WCI-850	WCI-1200
Order No.	Standard	W6011180	W6011260	W6011650	W6011850	W6011122*
	Sterilization	W6012180	W6012260	W6012650	W6012850	-
Chamber volume		180L	260L	650L	850L	1200L
Temperature Stability [°C]		±0.1°C (37°C)	±0.1°C (37°C)	±0.1°C (37°C)	±0.1°C (37°C)	±0.5°C (37°C)
Temp. Uniformity		±0.3°C (37°C / RT.20°C)	±0.4°C (37°C / RT.20°C)	±0.5°C (37°C / RT.20°C)	±0.5°C (37°C / RT.20°C)	±0.5°C (37°C / RT.20°C)
Heating Capacity [W]		320	610	1100	1400	1600
CO ₂ Inlet pressure range		0.3~0.5bar	0.6~0.7bar	0.7~1.0bar	0.7~1.0bar	0.7~1.0bar
Number of shelves		3/8	3/8	3/15	3/15	0/15*
Chamber dimension [WxDxH]		473x528x710mm	530x590x900mm	700x650x1430mm	700x800x1530mm	868x720x1927mm
Overall dimension [WxDxH]		560x620x945mm	630x680x1125mm	820x780x1740mm	820x930x1840mm	990x855x2123mm
Weight [kg]		80	115	230	260	323

Peltier-cooled CO₂ Incubator

This series of CO₂ incubators combines heating and peltier cooling systems, a perfect development from environmentally friendly and energy efficient heating and cooling technologies that facilitate excellent control accuracy and minimal fluctuations.

Specifications

Temp. Range:	+20~60°C
Temp. Resolution:	0.1°C
Dry Heat:	Up to 120°C
Temp. Control:	Digital PID
CO ₂ Range:	0% ~ 20%
CO ₂ Accuracy:	±0.1% (5% / 37°C)
CO ₂ Resolution:	0.1%
CO ₂ Sensor:	IR CO ₂ Sensor
Display:	LED Display
Operating panel:	Individual 2-Channel Touch Button
Jacket type:	Dry Wall Type (6 sides heat)
Chamber material:	Stainless Steel (304)



Model	WCI-40P	WCI-120P	WCI-180P	
Order No.	Standard	W6013040	W6013120	W6013180
	Sterilization	W6014040	W6014120	W6014180
Chamber volume	40L	120L	180L	
Temperature Stability [°C]	±0.1°C (37°C)	±0.1°C (37°C)	±0.1°C (37°C)	
Temp. Uniformity	±0.3°C (37°C / RT.20°C)	±0.3°C (37°C / RT.20°C)	±0.3°C (37°C / RT.20°C)	
Heating Capacity [W]	320	320	320	
CO ₂ Inlet pressure range	0.3~0.5bar	0.3~0.5bar	0.3~0.5bar	
Number of shelves	2/4	3/8	3/8	
Chamber dimension [WxDxH]	320x350x375mm	480x470x520mm	473x528x710mm	
Overall dimension [WxDxH]	420x520x570mm	580x560x765mm	560x680x945mm	
Weight (kg)	46	82	88	
Model	WCI-260P	WCI-650P	WCI-850P	
Order No. Standard	W6013260	W6013650	W6013850	
Chamber volume	260L	650L	850L	
Temperature Stability [°C]	±0.1°C (37°C)	±0.1°C (37°C)	±0.1°C (37°C)	
Temp. Uniformity	±0.4°C (37°C / RT.20°C)	±0.5°C (37°C / RT.20°C)	±0.5°C (37°C / RT.20°C)	
Heating Capacity [W]	610W	1100W	1400W	
CO ₂ Inlet pressure range	0.6~0.7bar	0.7~1.0bar	0.7~1.0bar	
Number of shelves	3/8	3/15	3/15	
Chamber dimension [WxDxH]	530x590x900mm	700x650x1430mm	700x800x1530mm	
Overall dimension [WxDxH]	630x760x1125mm	820x860x1740mm	820x930x1840mm	
Weight (kg)	125	260	296	

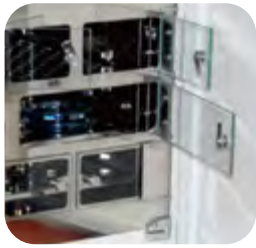

①



②



③



④



⑤



⑥



⑦

CO₂ Incubator Accessories

Order No.	Name	Description	Suitable for
W6010401	Stainless steel shelf	④ Perforated to improve uniformity	WCI-40
W6011201	Stainless steel shelf	④ Perforated to improve uniformity	WCI-120
W6011801	Stainless steel shelf	④ Perforated to improve uniformity	WCI-180, WCI-180R/S/Cu
W6012601	Stainless steel shelf	④ Perforated to improve uniformity	WCI-260
W6016501	Stainless steel shelf	④ Perforated to improve uniformity	WCI-650
W6018501	Stainless steel shelf	④ Perforated to improve uniformity	WCI-850
W6010402	Roller base	⑤ Height 20cm from Bottom	WCI-40
W6011802	Roller base	⑤ Height 20cm from Bottom	WCI-180, WCI-180R/S/Cu
W6011803	Stacking kit	⑥ Stacking Kit	WCI-180
W6011804	HEPA filtration	⑦ HEPA filtration of gas circulation, Standard	WCI-40/180/260/650, WCI-180R/S/Cu
W6018504	HEPA filtration	⑦ HEPA filtration of gas circulation, Standard	WCI-850
W6012604	HEPA filtration	⑦ HEPA filtration of gas circulation, dry Heat sterilization	WCI-260/650
W6010405	Water pan	Heated by 6 sides direct heating for humidity, dimension: Ø160mmx H 35mm	WCI-40
W6011805	Water pan	Heated by 6 sides direct heating for humidity, dimension: 230x160x50mm	WCI-180, WCI-180R/S/Cu
W6012605	Water pan	Heated by 6 sides direct heating for humidity, dimension: 325x265x65mm	WCI-260
W6016505	Water pan	Heated by 6 sides direct heating for humidity, dimension: 530x325x65mm	WCI-650/850
W6011806	UV lamp	UV lamp. Install the side of the top fan	All CO ₂ incubator
W6011809	Monitoring port	Analog connection port has been designed to observe the status of equipments in real time even in the far distance.	All CO ₂ incubator
W6011810	GAS regulator	② GAS regulator	WCI-40, WCI-180, WCI-180R/S/Cu
W6011811	CO ₂ Analyzer	③ CO ₂ Analyzer	All CO ₂ incubator
W6011812	Divided door	① 5 Divided Door	WCI-40
W6011813	Divided door	① 3 Divided Door, used for WCI-180	WCI-180, WCI-180Cu
W6011814	Divided door	① 6 Divided Door, used for WCI-180	WCI-180, WCI-180Cu
W6011815	Printer	Printer	All CO ₂ incubator
W6011816	Holes for auxiliary monitoring	Diameter of 30mm (40mm is available), on the left side of the incubator	All CO ₂ incubator

Portable Mini CO₂ Incubator

Compact & Economical Mini CO₂ Incubator

Features

- > Portable Use with carrying handles (Car Plug available)
- > Economical Price & Compact Design for Personal Use
- > Suitable size to use in work station or Clean bench
- > Digital control for Temperature & CO₂
- > Forced Air Circulation by Fan
- > Excellent Temperature Uniformity
- > Quick recovery & Precise CO₂ control by IR Sensor
- > Cooling with very low noise
- > Two Stainless Steel Shelves (Standard)
- > Natural Humidification by Water Pan
- > Cooling & Heating by peltier
- > Stainless steel Water Tray
- > Power Plug & Car Jack



Car Jack



Specifications

Product Name	WCI-15R	
Chamber Volume	15.2 liter	
Temperature	Range	15°C ~ 45°C (at Ambient 25°C)
	Accuracy	±0.25°C
	Control	Digital
CO ₂	Range	0 ~ 20%
	Sensor	Dual Beam IR Sensor
	Accuracy	±0.1% (5%)
	Gas Pressure	0.7Bar (Max. 1Bar)
Humidity	Up to 80%	
Display	LED Display	
Cooling & Heating	By Peltier (thermoelectric elements)	
Shelf	2, Stainless steel (standard) / Max (3ea)	
In & Outside Material	ABS	
Inside (W x D x H mm)	224x 200 x 340	
Outside (W x D x H mm)	292x 333x 433	
Weight	6.8Kg	
Power / Frequency	220V, 50/60Hz	
Power Consumption	DC-COLD: 46W, HOT: 48W	
	AC-COLD: 63W, HOT: 63W	
Order No.	189221	

Accessories & Options

Order No.	Name	Model
189231	Shelf (Stainless steel)	203M-SHELFUSUS (220x162mm-WxD)
189232	Measuring opening (Ø12mm)	203M-Hole

Copper Chamber CO₂ Incubator

copper plate inner chanler with better contamination effect, including all the features of the standard stainless steel version!



Specifications

Temp. Range:	RT. +5~60°C
Temp. Resolution:	0.1°C
Dry Heat:	Up to 120°C
Temp. Control:	Digital PID
CO ₂ Range:	0% ~ 20%
CO ₂ Accuracy:	±0.1% (5% / 37°C)
CO ₂ Resolution:	0.1%
CO ₂ Sensor:	IR CO ₂ Sensor
Display:	LED Display
Operating panel:	Individual 2-Channel Touch Button
Jacket type:	Dry Wall Type (6 sides heat)
Inner chamber material:	Copper plate

Model	WCI-40Cu	WCI-180Cu	
Order No.	Standard	W6028040	W6028180
	Sterilization	W6028041	W6028181
Chamber volume	40L	180L	
Temperature Stability [°C]	±0.1°C (37°C)	±0.1°C (37°C)	
Temp. Uniformity	±0.3°C (37°C / RT.20°C)	±0.3°C (37°C / RT.20°C)	
Heating Capacity [W]	320	320	
CO ₂ Inlet pressure range	0.3~0.5bar	0.3~0.5bar	
Number of shelves	2/4	3/8	
Chamber dimension [WxDxH]	320x350x375mm	473x528x710mm	
Overall dimension [WxDxH]	420x460x570mm	560x620x945mm	
Weight [kg]	38	80	

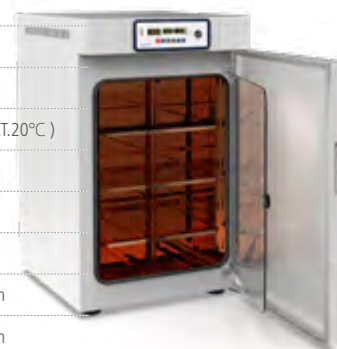

Tri-Gas Incubator (CO₂ / O₂ / N₂)

The Tri-Gas incubator is ideal for the experiments of the cultivation of animal cells, sperm/ovum, anaerobic cells, all sorts of microbe cells, hatching/germinating and special tissues.



Options

Customize your incubator with these options



Access port

25mm Access Port is available at left side. (Upon ordering and additional charge)



UV sterilization

4W UV is placed on the chamber ceiling and beside the circulation fan. The UV light cannot reach the sample and sterilization is operated during culturing.



Peltier cooling system

With Peltier cooling system in WCI-40T & WCI-180T, It can work below room temperature.



Copper chamber

WIGGENS customize chamber with copper plate chamber for enhanced contamination protection.



O₂ Control

Multi Gas Supply (N₂ & O₂) is available for all CO₂ incubators.



Hot air sterilization

Maximum 125°C Dry Hot Air in WCI-40T, WCI-180T
No need to remove IR CO₂ sensor



Monitoring System

Analog connection port has been designed to observe the status of equipments in real time even in the far distance.



Lower gas consumption. Lower heat loss.

Faster recovery easy classification for various samples.
5 Split Door for WCI-40T
6 Split Door for WCI-180T

Features

Fast heat-up, fast-recovery, reliable control

6 Sides Direct Heating System

The electric heating wire is covered on all sides of the chamber which makes good uniformity and provides fast heat-up & temperature recovery.

3 parts of heating section are controlled and calibrated individually by 3 individual temperature sensors.

Dry Wall and Air Jacket

Warm air from heating wire is preserved in space between the chamber and the insulation layer. It helps temperature recover faster and minimize heat loss.

Drywall withinsulation requires no regular maintenance.

DUAL BEAM IR CO₂ Sensor

Fast & precise detection for CO₂ gas regardless of temperature and humidity.

Natural Humidification using Water Tray

The heater on bottom warms the water in tray and it makes humidification. The circulation fan delivers the moisture formed from the water to the entire chamber.

No Condensation

Heating by front door heater & frame heater prevents condensation in the chamber and on the glass door.

Microprocessor PID Control

Intelligence Control for CO₂ density, Temperature, Alarm, Automatic Decontamination (Optional).

HEPA filtration

Gentle Air and Moisture Convection

Gentle air and moisture convection air and moisture in the chamber are distributed naturally by 6 side heating and the air circulation fan.

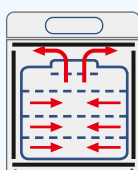

Over Heating Limit

Heating is automatically cut by safety device when temperature control failed or there is excessive heating over set point.

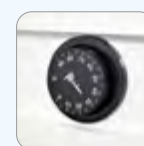

Easy to clean

Rounded corner allows easy cleaning. The entire chamber is made of stainless steel (SUS304)

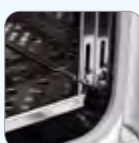

Perforated Shelves

Perforated shelves are good for natural air flows and are made of stainless steel which are resistant against rust and contamination.

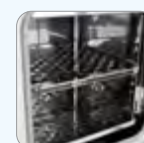

Alarm System

Buzzer to alarm low or high deviation of CO₂, Temperature.



Specifications

Model	WCI-40T	WCI-180T	WCI-850T
Volume	40L	180L	850L
Temperature	Range	Ambient+5°C ~60°C	Ambient+5°C ~60°C
	Accuracy	±0.1°C (37°C)	±0.1°C (37°C)
	Resolution	0.1°C	0.1°C
	Control	Digital PID	Digital PID
CO ₂	Range	0% ~ 20%	0% ~ 20%
	Accuracy	±0.1% (5% / 37°C)	±0.1% (5% / 37°C)
	Resolution	0.1%	0.1%
	Sensor	IR CO ₂ Sensor	IR CO ₂ Sensor
O ₂	Control	Microprocessor	Microprocessor
	Inlet pressure range	0.5~0.6bar	0.6~0.7bar
	Range	0.6~85%	0.6~85%
	Sensor	Zirconium dioxide sensor	Zirconium dioxide sensor
Display	LED Display	LED Display	LED Display
Operating panel	Individual 2-Channel Touch Button	Individual 2-Channel Touch Button	Individual 2-Channel Touch Button
Jacket type	Dry Wall Type (six-side gradient heating design)		
Chamber material	Stainless Steel (304)		
Number of shelves	2/4	3/8	3/15
Chamber dimension	320x350x375mm	473x528x710mm	700x800x1530mm
Overall dimension	420x460x570mm	560x620x945mm	820x930x1840mm
Weight	35kg	78 kg	266 kg
Order No. for standard version	W6021040	W6021180	W6021850
Order No. for dry heat sterilization version	W6022040	W6022180	W6022850

Constant Temperature Incubator

Versatile air-jacketed incubators.

Specially designed for uniform temperature distribution and minimal sample contamination caused by external air intrusion.

Features

- > Applicable in life science, pharmacy, medical science, chemistry, biology, and related fields for storage of samples which need constant temperature and incubation
- > Digital temperature display and control
- > PID controller for temperature stability and safety protection
- > Very good heating characteristics
- > Ecologically friendly
- > Easy to clean
- > Timer function
- > Can be opened anytime when necessary
- > When the temperature exceeds set levels and reaches the set safety value, an alarm activates, and the incubation process stops
- > The material of the observation window is tempered glass, which has good safety and sealing characteristics
- > The magnetic door and high-quality gasket can absorb external shocks and comprise excellent sealing characteristics
- > Easy-to-clean stainless steel shelves with good air permeability and adjustable height
- > Upon opening the incubator, the fan and heating device stop operation
- > Alarm starts for sample protection when the door is open for more than 60 seconds



Specifications

Model	WH-05	WH-10	WH-15	WH-25
Order No.	W6031050	W6031100	W6031150	W6031250
Volume [L]	50	100	150	260
Temperature Range [°C]	RT. + 5~65	RT. + 5~65	RT. + 5~65	RT. + 5~65
Temperature uniformity of working area [°C]	<±0.2 at 37°C and 25°C RT	<±0.2 at 37°C and 25°C RT	<±0.2 at 37°C and 25°C RT	<±0.2 at 37°C and 25°C RT
Temperature Stability [°C]	±0.1 at 37°C	±0.1 at 37°C	±0.1 at 37°C	±0.1 at 37°C
Temperature Controller	Digital Display with PID automatic regulation, Button Control			
Timer	1 min ~ 99 hr 59 min	1 min ~ 99 hr 59 min	1 min ~ 99 hr 59 min	1 min ~ 99 hr 59 min
Safety	Independent safety temperature protection, Open door alarm function			
Heating Capacity [W]	340	340	340	610
Shelves [included / max.]	2/3	2/4	2/8	3/8
Inner Dimensions [WxDxH in mm]	345 x 368 x 375	480 x 480 x 495	500 x 480 x 620	530 x 590 x 900
Outer Dimensions [WxDxH in mm]	440 x 480 x 610	560 x 560 x 760	560 x 580 x 880	630 x 680 x 1125
Weight [kg]	35	50	65	115
Power supply	AC 220~240 V, 50/60 Hz	AC 220~240 V, 50/60 Hz	AC 220~240 V, 50/60 Hz	AC 220~240 V, 50/60 Hz
Number of internal power outlets	-	-	-	-



Alarm System

Temperature Alarm, Independent safety temperature protection

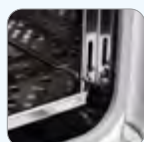

Easy to Clean

Rounded Conner allows easy cleaning. The entire chamber is made of stainless steel (SUS304)

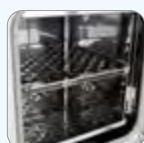

Perforated Shelves

Perforated Shelves are good for natural air flows and are made of stainless steel which is resistant to rust and contamination.

Materials

Housing	Powder coated stainless steel
Interior	Stainless steel
Shelves	Stainless steel
Inner transparent door	High temperature resistant glass, Thickness: 5 mm

Only for WH-1200

Temp. Recovery*	14 minutes at 37°C after door open for 5 minutes
Temperature Safety	5 Side direct heating with forced air flow by 4 circulation fans
Door	Front door (left open) with viewing glass window



Model	WH-400	WH-650	WH-850	WH-1200
Order No.	W6031400	W6031650	W6031850	W6031122
Volume [L]	400	650	850	1200
Temperature Range [°C]	RT. + 5~65	RT. + 5~65	RT. + 5~65	RT.+7~+60°C at 25°C RT
Temperature uniformity of working area [°C]	<±0.5 at 37°C and 25°C RT	<±0.5 at 37°C and 25°C RT	<±0.5 at 37°C and 25°C RT	±0.5~±0.7°C at 37°C and 25°C RT
Temperature Stability [°C]	±0.1 at 37°C	±0.1 at 37°C	±0.1 at 37°C	±0.1 at 37°C
Temperature Controller	Digital Display with PID automatic regulation, Button Control			
Timer	1 min ~ 99 hr 59 min	1 min ~ 99 hr 59 min	1 min ~ 99 hr 59 min	1 min ~ 99 hr 59 min
Safety	Independent safety temperature protection, Open door alarm function			
Heating Capacity [W]	700	1100W	1400W	1600W
Shelves [included / max.]	3/12	3/15	3/15	0/35
Inner Dimensions [WxDxH in mm]	600 x 630 x 1100	700 x 650 x 1430	700 x 800 x 1530	868 x 720 x 1927
Outer Dimensions [WxDxH in mm]	750 x 730 x 1430	820 x 780 x 1740	820 x 930 x 1840	990 x 855 x 2123
Weight [kg]	160	230	260	260
Power supply	AC 220~240 V, 50/60 Hz			
Number of internal power outlets	-	4	4	7

Low Temperature Incubator

Superb low temperature incubator by noiseless compressor cooling system

Features

- > Applicable in life science, pharmacy, medical science, chemistry, biology, and related fields for storage of samples which need a constant temperature and for incubation.
- > Heating function start and duration can be pre-set
- > Temperature control programs: Temperature programs can be divided into 9 sections and for every section temperature and duration can be set individually
- > 3 pre-set often used temperatures can be recalled anytime when necessary
- > Temperature measure unit can be set as either °C or °F
- > When the temperature exceeds set levels and reaches the set safety value, an alarm activates, power is cut off, and the incubation process stops
- > With tempered glass window, the examination of samples is easy and convenient, avoiding unnecessary disruptions of the incubation process
- > The stainless steel shelves have a good air permeability, are easy to clean and can be adjusted in height
- > In case of an unexpected power breakdown the incubator offers two working options: automatic re-operation and automatic stop
- > When opening the incubator, the fan and heating device stop operation. After one minute without closing the door an alarm starts
- > Incubators use heat transfer method for circulation. In a separated room outside the work space it uses heat exchange, In the working space it uses natural convection and forced circulation
- > The circulation method will not induce air pollution and can guarantee exact temperature distribution

Accessories

Order No.	Name	Description
W6052501	Stainless steel shelves	Perforated to improve uniformity, Suitable for WH-11C / 21C
W6052502	Stainless steel shelves	Perforated to improve uniformity, Suitable for WH-40C
W6011816	Holes for auxiliary monitoring	Diameter of 30mm, on the left side of the incubator
W6051502	Socket inside the chamber	Optional, factory installation
W6051503	LED light	At the top of the chamber



Specifications

Model	WH-11C	WH-21C	WH-40C
Order No.	W6055150	W6055250	W6055400
Temperature Control Method	Forced circulation method (fans integrated outside of the work space)		
Volume [L]	150	250	400
Temperature Range [°C]	+4 ~ 60	+4 ~ 60	+4 ~ 60
Temperature Stability [°C]	±0.1°C	±0.1°C	±0.1°C
Temperature uniformity of working area [°C]	±1.5 (37°C)	±1.5 (37°C)	±1.5 (37°C)
Temperature Controller	Digital Display with PID automatic regulation, push button		
Timer	1 min ~ 99 hr 59 min	1 min ~ 99 hr 59 min	1 min ~ 99 hr 59 min
Heating Capacity [W]	450	450	450
Max. Cooling Capacity [W]	350	350	400
Shelves [included / max.]	2/5	3/7	3/7
Inner Dimensions [W×D×H in mm]	550 x 500 x 610	550 x 500 x 1000	630 x 600 x 1100
Outer Dimensions [W×D×H in mm]	660 x 605 x 1020	660 x 605 x 1415	750 x 730 x 1550
Weight[kg]	95	120	160
Power supply	AC 220 ~ 240V, 50/60 Hz		

Peltier-cooled Incubator

This series of incubators combines heating and peltier cooling systems, a perfect development from environmentally friendly and energy efficient heating and cooling technologies that facilitate excellent control accuracy and minimal fluctuations.

Features

- > Applicable in life science, pharmacy, medical science, chemistry, biology, and related fields for storage of samples which need a constant temperature and for incubation.
- > Heating function start and duration can be pre-set
- > There are four temperature programs available for editing, and each program can be edited in 5 steps
- > Four temperature can be preset for quick changeover
- > Temperature measure unit can be set as either °C or °F
- > When the temperature exceeds set levels and reaches the set safety value, an alarm activates, power is cut off, and the incubation process stops
- > With tempered glass window, the examination of samples is easy and convenient, avoiding unnecessary disruptions of the incubation process
- > The stainless steel shelves have a good air permeability, are easy to clean and can be adjusted in height
- > When temperature deviation occurs, the BIAS function sets in, which makes operation convenient
- > In the case of an unexpected power breakdown the incubator offers two working options: automatic re-operation and automatic stop
- > When opening the incubator, the fan and heating device stop operation. After one minute without closing the door an alarm sets in
- > Incubators use heat transfer method for circulation. In a separated room outside the work space it uses heat exchange, In the working space it uses natural convection and forced circulation
- > The circulation method will not induce air pollution and can guarantee exact temperature distribution



Specifications

Model	WH-01	WH-02	WH-10P	WH-15P
Order No.	W6053015	W6053050	W6053100	W6053150
Temperature Control Method	Forced circulation			
Volume [L]	15	50	100	150
Temperature Range [°C]	+4 ~ 60 (at 20°C RT)	+4 ~ 60 (at 20°C RT)	+10 ~ 60 (at 20°C RT)	+10 ~ 60 (at 20°C RT)
Temperature Stability [°C]	±0.1°C	±0.1°C	±0.1°C	±0.1°C
Temperature Controller	Touch Control; Digital Display with PID automatic regulation			
Timer	1 min ~ 999hr 59 min / continuous			
Heating Capacity [W]	150	300	450	450
Max. Cooling Capacity [W]	350	350	350	350
Shelves [included / max.]	2/5	3/7	3/7	3/7
Inner Dimensions [W×D×H in mm]	200 x 320 x 240	370 x 410 x 390	480 x 480 x 500	505 x 480 x 620
Outer Dimensions [W×D×H in mm]	470x 400 x 430	460 x 630 x 610	620 x 600 x 800	620 x 625 x 920
Weight[kg]	24	35	65	80
Power supply	AC 220 ~ 240V, 50/60 Hz			

Forced Convection Oven

Ideal for high temperature storage with user-friendly design.
WF-G Models are used for all sterilization and drying tasks that do not require high drying rates or special time requirements and ideal for drying applications requiring gentle airflow.

Features

- > Microprocess PID control / Calibration.
- > Over temperature limit protection / Door opening alarm.
- > Conveniently preset 3 most commonly used temperature settings.
- > Gravity-flow convection with vertical airflow for uniform sample heating.
- > Featuring a pull out door handle.
- > Rounded inner chamber corners for easy cleaning and better air-flowing.
- > Stainless steel interior.
- > Two circular adjustable top slide vents help to control inner air vapor circulation (inside diameter 35mm)



Specifications

Model		WF-02G	WF-12G	WF-22G	WF-40G
Order No.	Without glass window (250°C)	W6061050	W6061100	W6061150	W6061400
	With glass window (250°C)	W6061051	W6061101	W6061151	-
Chamber Volume (L)		50	100	150	400
Temperature	Range (°C)	Amb.+10~250 / 300	Amb.+10~250 / 300	Amb.+10~250 / 300	Amb.+10~300
	Resolution	0.1°C	0.1°C	0.1°C	0.1°C
	Fluctuation at 100°C (°C)	0.5	0.6	0.8	0.5
Time setting		1 min ~ 99 hr 59 min, delayed ON / OFF.			
Display		Digital LED display			
Dimension (W×D×H)	Interior (mm)	400×420×420	480×460×500	500×480×625	1080×574×840
	Exterior (mm)	540×620×780	600×690×810	660×750×920	1240×792×1123
Number of shelves		2ea (Max shelves 8ea)	2ea (Max shelves 12ea)	2ea (Max shelves 14ea)	2ea (Max shelves 10ea)
Weight (kg)		55	62	72.5	100.5
Heating power (W)		1000	1200	1200	3400

Accessories & Options

Perforated Shelves

Stainless steel shelves are easily removable without using tools for easy cleaning.



Order No.	Description W x L (mm)	Model
W6060501	360×310	WF-02G
W6061001	450×380	WF-12G
W6061501	465×400	WF-22G
W6064001	988×490	WF-40G



Threefold tempered glass viewing window allows for easy monitoring of samples.



Shaking Incubator CO₂ Shaking Incubator

Shaking Incubator

Combining a benchtop incubator/refrigerator with a dual-action (orbital and reciprocal) shaker, WS series shaking incubators offer versatility for a variety of biological and biotech applications.

Shaking Features

- > Dual shaking modes: orbital or reciprocal.
- > Speed range: 30 to 300 rpm.
- > Programmable shaking motion.
 - Timer range: 10 sec to 999 hr 59 min 59 sec.
 - Forward & Backward, Pause: 10 sec to 59 min 59 sec.
- > Selectable stroke length: 20, 30, 40mm.

Operating Features

- > Temperature control:
 - +5°C above ambient to 60°C . (for WS-300 and WS-600)
 - +15°C to 60°C . (for WS-300R and WS-600R)
- > Microprocessor PID control.
- > Simple calibration and auto-tuning functions.
- > Digital timer with delayed ON/OFF function: 1 min to 99 hr 59 min.
- > High temperature limit setting and open door alarm.
- > Convenient preset function for 3 most commonly used temperature settings.
- > Up to 9 temperature steps and maximum 200 cycles of repetition and programmable for each profile.
- > Adjustable 3-step fan speed with defrosting time and period control.
- > Intuitive control panel with bright LED display (0.1°C resolution) and push button keypad.
- > RS-232 interface.



Optional Accessories

- > Universal / Dedicated Platforms, Rubber Mats, Universal Attachments
- > Flask Clamps, Funnel Clamps
- > Test Tube Racks, Spring Wire Racks
- > Microplate Holders (three styles)
- > Lab Sticker

Constructional Features

- > Maintenance-free and durable BLDC motor.
- > High-velocity fan ensuring uniform temperature distribution and rapid thermal recovery.
- > Convenient sample monitoring thanks to the transparent acryl lid and the fluorescent lamp.
- > Gas spring lid supports providing soft closing, smooth motion, and stopping.
- > Environment-friendly CFC-free refrigerant.

Specifications

Product Name	WS-300	WS-300R	WS-600	WS-600R	
Volume(L)	53	53	83	83	
Temperature	Range(°C)	Ambient +5 ~ 60	15~60	Ambient +5 ~ 60	15 ~ 60
	Accuracy(°C)	±0.1 (38)	±0.1 (38)	±0.1 (38)	±0.1 (38)
	Stability(°C)	±1.0 (38)	±1.0 (38)	±1.0 (38)	±1.0 (38)
	Controller	Push button keypad.; Digital Display with PID automatic regulation			
	Heater	Heating Plate, 600W			
		Timer			Start / Stop / Duration setting; 10sec ~999hr 59min 59sec
Shaker	Controller	PID automatic regulation			
	Power Unit	Brushless motor			
	Methods	Clockwise, Counter-clockwise, forth-back, interrupted,			
	Shaking Throw (mm)	20, 30 (standard), 40	20, 30 (standard), 40	20, 30 (standard), 40	20, 30 (standard), 40
	Speed (rpm)	30 ~ 300	30 ~ 300	30 ~ 300	30 ~ 300
	Stability (rpm)	± 1 (at 150rpm)	± 1 (at 150rpm)	± 1 (at 150rpm)	± 1 (at 150rpm)
Dimensions	Platform (W × D in mm)	350 × 350	350 × 350	450 × 450	450 × 450
	Inside (W × D × H in mm)	410 × 410 × 320	410 × 410 × 320	510 × 510 × 320	510 × 510 × 320
	Outside (W × D × H in mm)	440 × 740 × 625	440 × 740 × 625	540 × 850 × 625	540 × 850 × 625
Net Weight (kg)	74	85	91	102	
Max. Load (kg)	10	10	15	15	
Order No.	W6091050	W6095050	W6091080	W6095080	

Accessories for Shaker Incubator



Sticky Plate

The Wiggins Sticky Plate can be loaded with any kind of vessels with a smooth base. Even at a speed of up to 350 rpm the vessel sticks to the plate. Other vessels, like microtitre plates, can be shaken on the Wiggins Sticky Plate as well. but, only up to a speed of 220 rpm.

Suitable for	WS-300/300R	WS-600/600R
Order No.	31901	31902
Dimensions (W x D in mm)	350x350(mm)	450x450(mm)



Multi-Purpose Tray

The multi-purpose tray is made of stainless steel and can be used for a diverse range of unusual specifications.

Suitable for	WS-300/300R	WS-600/600R
Order No.	31521	31522
Dimensions (W x D in mm)	350x350	450x450
Max. Load of Flasks		
50ml	16	25
100ml	9	16
250ml	4	9
300ml	4	9
500ml	4	5
1L	2	4
2L	1	2
2.8L	1	2

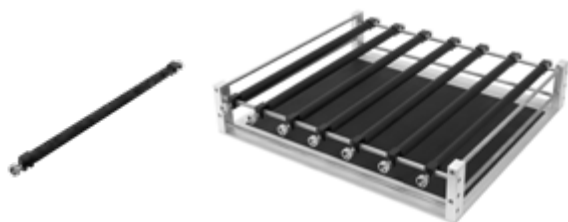

Adjustable bar tray

Suitable for	WS-300/300R	WS-600/600R
Order No.	31514	31515
Dimensions (W x D in mm)	300x300(mm)	400x400(mm)
Number of bar	3	3
Order No. of bar	31514-05	31515-05

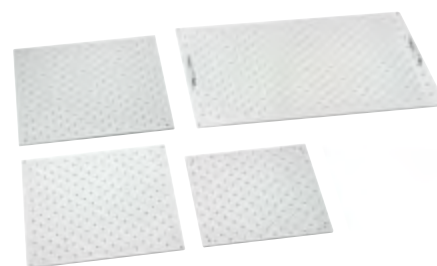

Universal Trays

The Universal Trays employ a drilled grid for individual loadings of test tube holders, microtitre plates, and deep well plates.

Suitable for	WS-300/300R	WS-600/600R
Order No.	31501	31502
Dimensions (W x D in mm)	350x350(mm)	450x450(mm)
Max. Load of Flask Clamps (kg)		
50ml	28	45
100ml	24	36
250ml	13	18
300ml	13	18
500ml	10	13
1L	5	7
2L	4	5
2.8L	1	2
4L	-	-
Max. Load of Separatory Funnel Clamps (kg)		
250ml	4	6
500ml	2	3
1L	-	2
2L	-	-

Multi-Pore Holders

The Wiggins multi-pore holders can be installed on the Wiggins sticky plates or the Wiggins universal trays. All holders can be installed on small pores and deeper holes. In total, four different multi-pore holders are available:

1. Multi-Layer Holder
2. Single-Layer Single-Position Holder
3. Single-Layer Three-Position Holder
4. Single-Layer Four-Position Holder



Max. No. of Mountable Holders	Multi-Layer	Four-Position	Three-Position	Single-Position
Order No.	23651	23652	23653	23654
Max. mountable holders				
WS-300/300R	6	--	2	8
WS-600/600R	10	2	3	15



Rubber mats

Designed for low-speed applications, non-skid rubber mats allow quick addition or removal of flasks, plates or tubes.

Suitable for	WS-300/300R	WS-600/600R
Order No.	31531	31532



Separatory funnel clamps

Funnel Volumes	250mL	500mL	1L	2L
Order No.	23562	23563	23564	23565



Erlenmeyer flask clamps

Size of flask	Reference No.	Order No.
25mL	31274	-
50mL	31279	23550
100mL	31271	23551
250mL	31275	23552
300mL	-	23556
500mL	31280	23553
1000mL	31272	23554
2000mL	31273	23555
2800mL Fernbach	-	23557
3000mL	31277	-
4000mL	31278	23558
5000mL	31281	-
6000mL	-	23559

Plastic clamps for erlenmeyer flask

Order No.	Description	Order No.	Description
31285	100ml	31287	500ml
31286	250ml		

Stainless steel clamps for fernbach flask

Order No.	Description	Order No.	Description
31283	1.8L	31284	2.8L



Test tube rack for long type

Order No.	Description	Order No.	Description
31342	144 x Ø8mm	31356	39 x Ø18mm
31343	100 x Ø10mm	31358	36 x Ø20mm
31347	72 x Ø12mm	31359	33 x Ø22mm
31352	64 x Ø14mm	31360	20 x Ø25mm
31354	36 x Ø16mm	31361	16 x Ø30mm

Test tube rack for short type

Order No.	Description
31348	72 x Ø12mm
31353	64 x Ø14mm
31357	39 x Ø18mm (Suitable for Greiner Bio-one tube)

Rack for plastic test tube

Order No.	Description
31355	36x Ø16mm (15ml)
31362	16x Ø30mm (50ml)

187mm test tube rack for short type

Order No.	Description	Order No.	Description
31344	44 x Ø12mm	31349	21 x Ø20mm
31346	24 x Ø18mm		

CO₂ Incubator with Roller installed inside

WIGGENS CO₂ incubator with a roller apparatus or shaker inside the chamber, for adherent cells culture in the incubator. All operations and controls are on the external control panel. In addition to all the functions of the WCI-180, the CO₂ incubator with roller apparatus has the following features:

- > 180-litre CO₂ with roller apparatus installed inside
- > Low noise by using a low vibration DC brushless motor
- > CO₂, humidity and temperature have good uniformity in the chamber
- > The roller apparatus can be easily removed for static cell culture
- > The external controller can control the internal rollers individually, and the speed displays on the TFT screen
- > The temperature and CO₂ value are displayed and controlled on the LED screen

Model		WCI-180R
Display of the incubator		LED
Capacity		180L
Temperature	Range	Rt+5-60°C
	Display Precision	±0.1°C (37°C)
	Resolution	0.1°C
Speed control	Speed	2~30rpm
	Accuracy	±1rpm
	Division	0.1rpm
	Control	PID microprocessor
Humidity		≥70% (at 37°C)
CO ₂	accuracy	±0.1% (5% / 37°C)
	Resolution	0.1%
	Sensor	Dual infrared CO ₂ sensor
		PID microprocessor
Timer		Continuous or up to 99h 59min
Jacket style		Air (six-side heating)
Interior material		304 stainless steel
Shelf		One for roller apparatus, and above space for static culture
Order No.		W6026180



Four Dia.100-120mm roller bottles can be installed with speed controller on the outside

Controller outside can monitor and control speed without opening the door.



More information about remote roller Celrol Mini, please refer to the page 148

CO₂ Incubator with Shaker installed inside

In addition to all the functions of the WCI-180, the CO₂ shaking incubator has the following features:

- > 180-litre CO₂ incubator with shaker installed inside
- > Low noise by using a low vibration DC brushless motor
- > CO₂, humidity and temperature have good uniformity in the chamber
- > The shaker can be removed for static cell culture
- > The standard universal plate, optional sticky plate
- > A variety of plate types (Erlenmeyer flasks: 100mL, 250mL, 500mL, 1000mL, test tube clamps, 96-well plates)
- > The external controller can control the internal rollers individually
- > The speed, temperature and CO₂ value are displayed and controlled on the LED screen

Model		WCI-180S
Display		LED
Capacity		180L
Platform Size (W x L mm)		300x330
Temperature	Range	Rt+5-60°C
	Display Precision	±0.1°C (37°C)
	Resolution	0.1°C
Speed control	Speed	30-300 rpm
	Accuracy	±1rpm
	Division	1rpm
	Control	PID microprocessor
Humidity		≥70% (at 37°C)
CO ₂	Accuracy	±0.1% (5% / 37°C)
	Resolution	0.1%
	Sensor	Dual infrared CO ₂ sensor
		Microprocessor
Timer		Continuous or up to 99h 59min
Jacket style		Air (six-side heating)
Interior material		304 stainless steel
Shelf		One for shaker
Order No.		W6027180



Flasks with volume of 100~1000ml can be put on the shaker inside. Brushless DC motor makes it low vibration, dust-free, low noise and very suitable for cell culture

Controller outside can monitor and control speed without opening the door.



More information about shaker SRC, please refer to the page 138

CO₂ Shaking Incubator

The WIGGENS shaking CO₂ incubator is ideal for use in the fields of biosimilar production, proteomics, crystallography, genomics, cell biology and new drug development. A large capacity CO₂ incubator with separable long life shakers provides the optimum solution for cell suspension culture.

The internal chamber is subdivided into 3 compartments each holding a separable orbital shaker which can hold Erlenmeyer, cylindrical flasks or deep well blocks. The dual beam Infrared sensor provides precise CO₂ control while the six side heating system ensures excellent temperature control and recovery and also humidity. An outstanding air circulation system ensures temperature uniformity within all compartments.

The unique patented orbital shakers are constructed with stainless steel to minimize contamination and cleaning. Well sealed plate type BLDC motor allows these shakers to be used in highly humid environment and operate without noise, vibration or particulate generation. These powerful shakers can be used for many years with reliability guaranteed.



Features

Cell suspension culture

The CO₂ shaking incubator is designed for the suspension culture of eukaryotic cells such as CHO, HEK, Hela etc. but can also be used as a static incubator if required.

Infrared sensor

Industry standard dual beam infrared sensor is used to maintain control of CO₂ density

Pullout shaker platform

The platform of each shakers can be pulled out for loading flasks on each shakers efficiently.

Sticky mat & various holders

The orbital shakers can be used with sticky mats or dedicated flask holder trays or universal flask/tube holder plates.

Individual shaker control

Each orbital shaker can be individually controlled by an external control panel.

Excellent temperature control

All 6 sides are directly heated and combined with PID control to ensure that temperatures are reached quickly and uniformity is maintained. Further the system combines forced air and natural convection to maintain the best temperature uniformity at all times.

High and natural humidification

A deep and wide humidity tray allows high and natural humidity to be generated.

Split inner glass doors

The internal chamber is separated into three compartments, each with its own shelf, shaker and glass door. This design prevents excessive loss of heat and CO₂ when removing flasks etc.

Humidity display

LED display of actual humidity in the chambers informs the user of time to supplement the water in the humidity tray

Auto restart function

Each shaker has an autostart function so that if the glass inner door to each compartment is opened the shaker in that compartment stops and starts again when the door is closed. Auto start is also enabled if there is a power cut.

UV lamp

A UV lamp sited next to the circulation fan works to sterilize the air in the incubator even during cell culturing. The UV lamp can be turned on or off by a switch on the front panel.

Stain resistant interior

The inner chamber and all orbital shakers are constructed with stainless steel SUS304 which is designed for use in GMP facility and is resistant to rust formation under high humidity conditions

Anti-bacterial filter

A HEPA filter, located in post circulation fan, traps microbes and helps to maintain a sterile environment.

Removable shelves

Larger growth vessels like 5 or 10 liter flasks can be accommodated by completely removing the shelves

Specifications

Model	WCI-650CH	WCI-850CH
Display	LED	LED
Chamber volume	650L	850L
Temp.	Range	Ambient +5-60°C
	Accuracy	±1°C (at 37°C)
Shaker	Shaking motion	Orbital
	Speed range	30-300 rpm
	Speed accuracy	±1rpm
	Speed increment	1rpm
Humidity	Orbit diameter	25mm
	Range	≥70% (at 37°C)
CO ₂	Accuracy	±0.3% (at 5% at 37°C)
	Sensor	IR CO ₂ sensor
	Inlet pressure	0.7-1 bar
Time	Time range	Continuous or up to 99h59min
	Time accuracy	±1%
	Time increment	1min
Jacket type	Air jacket type (6-side heating)	Air jacket type (6-side heating)
Filter	Anti-Bacterial HEPA filter	Anti-Bacterial HEPA filter
Sterilization	U.V 4Wx1ea	U.V 4Wx1ea
Shelves	3ea	3ea
Dimension (WxDxH)	Chamber dimensions	700x650x1430mm
	Platform size	520x520mm
	Each compartment dimension	Compartment 1 (Bottom): 700x650x430 mm Compartment 2, 3 (Middle,Top): 700x650x380mm
	Overall dimensions	820x780x1740mm
Weight	323Kg	393Kg
Power	220V, 50/60Hz	
Order No.	W6027650	W6027850

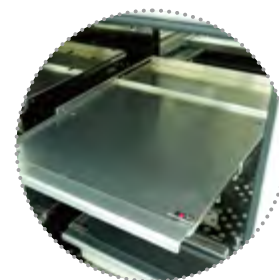
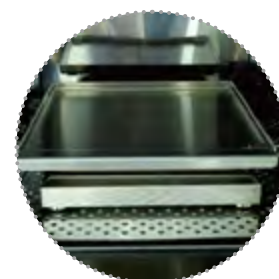

Maximum allowance for flask capacity

WCI-650CH	WCI-850CH
100mL x 156	100mL x 156
250mL x 90	250mL x 90
500mL x 60	500mL x 60
1000mL x 48	1000mL x 48
2000mL x 9	2000mL x 27

*Optimum performance for maximum allowance can be obtained at 150rpm.

Universal Trays

The Universal Trays employ a drilled grid for individual loadings of test tube holders, microtitre plates, and deep well plates.



Suitable for	WCI-650CH / WCI-850CH
Order No.	W6100402
Dimensions (W x D in mm)	520 x 520

Sticky Plate

The Wiggins Sticky Plate can be loaded with any kind of vessels with a smooth base. Even at a speed of up to 350 rpm the vessel sticks to the plate. Other vessels, like microtitre plates can be shaken on the Wiggins Sticky Plate as well. but, only up to a speed of 220 rpm.



Suitable for	WCI-650CH / WCI-850CH
Order No.	W6100401
Dimensions (W x D in mm)	520 x 520

Multi-Purpose Tray

The multi-purpose tray is made of stainless steel springs and can be used for a diverse range of unusual specifications.



Suitable for	WCI-650CH / WCI-850CH
Order No.	W6100403
Dimensions (W x D in mm)	520 x 520



Erlenmeyer flask clamps

Size of flask	Reference No.	Order No.
25mL	31274	-
50mL	31279	23550
100mL	31271	23551
250mL	31275	23552
300mL	-	23556
500mL	31280	23553
1000mL	31272	23554
2000mL	31273	23555
2800mL Fernbach	-	23557
3000mL	31277	-
4000mL	31278	23558
5000mL	31281	-
6000mL	-	23559



Ultrasonic Cleaner Ultrasonic Shaking Water Bath

Ultrasonic Cleaner

Ultrasonic Cleaning Technology

The cavitation phenomenon consists of formation and growth of millions of microscopic bubbles under a low-pressure stage, produced into the ultrasonic bath due to a high power transducer 37kHz. These bubbles break in all directions and attack every surface in contact with water, erasing dirt, impurities and pollutants when in contact with materials or pieces in the bath. This phenomenon allows cleaning all kinds of materials and products without the need of disassembling, due to all the surfaces being in contact with the liquid. The heating will accelerate this clearing process.

Eco Series

- > Wide range of available capacities from 3L up to 22L
- > Inner and outer parts made of stainless steel
- > Comes with a tray to conveniently place objects to be cleaned
- > Features a digital timer with up to 99 min

Pro Series

- > Entails all advantages of the Eco series
- > LCD touch screen for simple and intuitive operation
- > Features a digital timer with up to 199 min
- > Working power adjustable between 40% and 100%
- > Heating ability between 20°C and 80°C
- > Comes with a tray and a lid
- > Stainless steel 304 tank and powder coated stainless steel, meet the requirements of antiseptic and hygienic lab environment
- > Independent degas function
- > Automatically save last parameters and recall when the unit is turned back on
- > Non-slip feet and flexible surface contact for lower ultrasonic vibration
- > Safety handles make the unit portable
- > Maintain ultrasonic efficiency at different temperatures
- > Frequency overload and thermal protection

Application

- > Laboratories: laboratory material, precision instruments, pipettes, sieves, etc.
- > Medicine: instrumentation in general, surgical material, etc.
- > Odontology: dental prosthesis, instrumentation, etc.
- > Optics: instrumentation, opticals, frames, etc.
- > Industry: printed circuits, electronic components, etc.
- > Jewellery: watches, jewels, etc.
- > Automation: Injector clearing.
- > Degasification or liquid dissolution
- > Compact substances disgregation



Specifications

Model	Capacity L	Internal Size (LxWxH) mm	Overall Size (LxWxH) mm	Working Power W	Heater Power W	Temp. °C	Frequency Khz	Timer min	Drainage outlet
Eco Series									
UE03SFD	3	240×140×100	270×160×240	90	--	--	40	1~99min	Without
UE06SFD	6	300×150×150	330×180×290	160	--	--	40	1~99min	With
UE10SFD	10	300×240×150	360×270×310	250	--	--	40	1~99min	With
UE15SFD	15	330×300×150	390×330×310	350	--	--	40	1~99min	With
UE22SFD	22	500×300×150	570×330×330	500	--	--	40	1~99min	With
Pro Series									
UA03MFDN	3	240×137×103	301×163×342	Max.100 (40-100% adjustable)	88	20~80	37	1~199min	Without
UA06MFDN	6	300×153×150	362×180×305	Max.150 (40-100% adjustable)	170	20~80	37	1~199min	With
UA10MFDN	10	300×240×150	383×267×305	Max.200 (40-100% adjustable)	270	20~80	37	1~199min	With
UA22MFDN	22	500×300×150	584×327×327	Max.400 (40-100% adjustable)	550	20~80	37	1~199min	With

Ultrasonic Shaking Water Bath

Ultrasonic bath with shaking device for sample preparation

Wiggins ultrasonic shaking water bath combines the function of ultrasonic cleaner and shaking water bath. Both procedures can be carried out simultaneously or separately. This means that a sample can be pre-homogenized at a specified shaking frequency, and then final homogenization can be achieved in a very short time using ultrasound.

- > Shaking standard 20 mm , 30mm and 40mm are optional
- > Rack is easy to remove
- > With drainage outlet

Max. Load of flasks

- > 6 X 250ml
- > 6 X 300ml
- > 2 X 500ml
- > 2 X 1L
- > 1 X 2L



Applications

Biochemical research, material testing, enzyme and tissue studies, homogenization, routine laboratory tasks, corrosion tests, fermentation, incubation, blood plasma thawing, temperature tests of food and beverages

Specifications

Order No.	Model	Temp.	Frequency	Working Power	Heater Power	Timer	Drainage outlet	Capacity	Shaking stroke
		°C	Khz	W	W	min		L	mm
W30380122	WUS22	20-80	37	Max.400 (40-100% adjustable)	550	1~199min	With	20	20 (30 / 40)

Accessories for Ultrasonic Cleaner

Some accessories are very suitable for the Ultrasonic Cleaner, protecting the tank body, and some small parts need special containers to ensure to be placed at the bottom of the tank.



Lid for reducing the noise

Order No.	Name	Suitable for Volume
U10003	SS Lid	3L
U10006	SS Lid	6L
U10010	SS Lid	10L
U10015	SS Lid	15L
U10022	SS Lid	22L



Tray

Order No.	Name	Suitable for Volume
U10203	Tray	3L
U10206	Tray	6L
U10210	Tray	10L
U10215	Tray	15L
U10222	Tray	22L



SS Insert basket

Order No.	Name	Suitable for Volume
U10103	Insert basket	3L
U10106	Insert basket	6L
U10110	Insert basket	10L
U10115	Insert basket	15L
U10122	Insert basket	22L



Positioning lids

Order No.	Name	Suitable for Volume
U10403	Lid	3L
U10406	Lid	6L
U10410	Lid	10L
U10415	Lid	15L
U10422	Lid	22L

Test tube holder / Drain pipe

Order No.	Description
U10503	Test tube holder, suitable for 3~22L Ultrasonic Cleaner
U10606	Drain pipe, suitable for 3~22L Ultrasonic Cleaner



Stabilizing rings for Erlenmeyers

- > - PVC covered steel
- > - suitable for Erlenmeyers, flasks, etc.
- > Application: The weight of the ring prevents flasks from floating when placed in a thermal bath.



Order No.	Model	Colour	Size (OD) x (ID)	Weight
5660	Type S	Red	Ø 70×Ø 27 mm	0.3 kg
5661	Type M	Yellow	Ø 105×Ø 52 mm	0.5 kg
5662	Type L	Blue	Ø 140×Ø 76 mm	1.2 kg



Wiggens Analytics

Auto Titrator

Make titration easier...

CAT Automatic Titrator has been designed to simply and precisely perform the widest range of potentiometric titrations, and has always been the first choice if you are looking for a very easy-to-use automatic titrator for any application. A special training or a deeper knowledge of automatic titration are not necessary to get precise and quick results. That and much more is exactly what the new generation of CAT stands for:

- > High resolution pH/mV-measurement input for pH-, silver-, mV-electrodes and double platinum electrode
- > Pt 100 temperature measurement input for automatic temperature compensation
- > Pre-installed standard methods for alkalinity, total acidity in drinks, free and total SO₂ in wine, chloride etc.
- > Constant and progressive titration to equivalent points
- > Titration to pH and mV-end points
- > Automatic pH measurement (If the auto sampler is present)

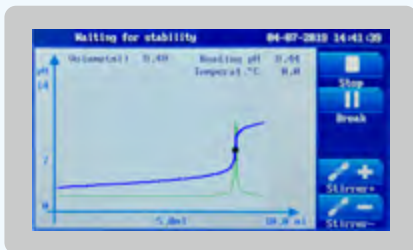

Typical applications of water/wastewater and environmental analysis

- > Automatic pH measurement
- > Alkalinity (p+m value)
- > Total kjeldahl nitrogen
- > Chloride in wastewater

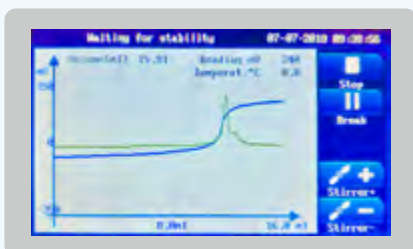

Typical applications of food analysis

- > Salt content (chloride, sodium chloride)
- > pH-value, total acidity in wine, drinks and other food products
- > Ascorbic acid
- > protein determination (Kjeldahl-nitrogen in milk and dairy products)
- > Free SO₂, total SO₂ determination in wine
- > Iodine and peroxide value

CAT. Everything you need. The advantages at a glance.



Brilliant

Bright display with strong illumination can be viewed easily from a long distance.



Auto-level adjuster

Designed to optimize the procedure of samples auto level, in order to speed up the sample preparation.



Compact

Compact instrument and can be both upgraded and configured to satisfy the ever challenging laboratory needs.



Auto-degassing system

Nitrogen valve for sample degassing.



Easy-to-use

The wide colour touch screen display contains all the messages and the icons that make CAT extremely easy to use. The titrator guides the user in each programming phase, analysis and data interpretation.

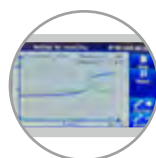

Titration curve

During the titration process the graphic trend is displayed in real time, so that the operator is immediately informed about the analysis trend.



Modular design

Up to 2 burettes and 3 peristaltic pumps, operating together or separately, every stage of titration process can be made truly automatic.



Report

pH electrode calibration report, Standard titration report and Sample titration report.



Peripheral modules

Single analysis stand, 16-position autosampler, 35-position autosampler, printer and software.

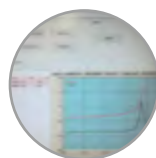

Software

Data management software via external PC



Methods

Default methods, Method template make it quick to edit and start your experiments.



Plug and Play

Intelligent operating concept. Ready for operation with just a few quick and easy steps.

Features



Standard methods

- > Pre-installed standard methods for alkalinity, total acidity in drinks, chloride, SO₂ in wine etc.
- > Each standard method can be used directly or edited according to actual needs
- > The commonly used titration method can be marked and set to the top, which is easy for operators to choose quickly.

Menu

Built-in system setting, date and time setting, calibration solution setting, operator setting, burette manual operation, creep pump manual operation, electrode lifting device manual setting, and continuous titration turntable manual setting function

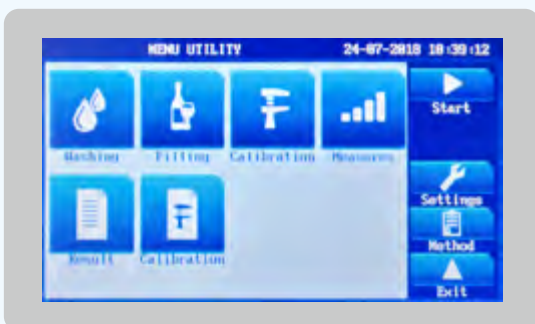
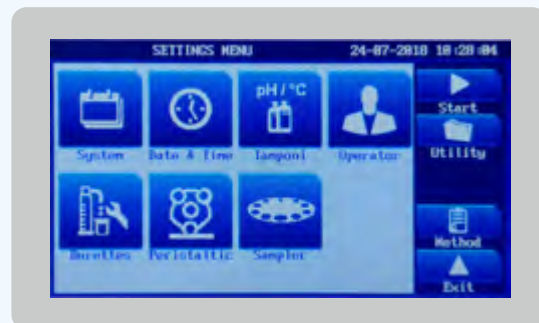

Utility

Including: manual setting of cleaning steps, manual filling of burette, calibration program settings, pH measurement settings, titration results query, import, transfer and deletion, calibration reports and records

Titration curve

- > During the titration process, the titration curve is displayed in real time, and the integral curve will be shown after the titration is finished
- > After titration, display titration results, including starting values, ending values and calculation results

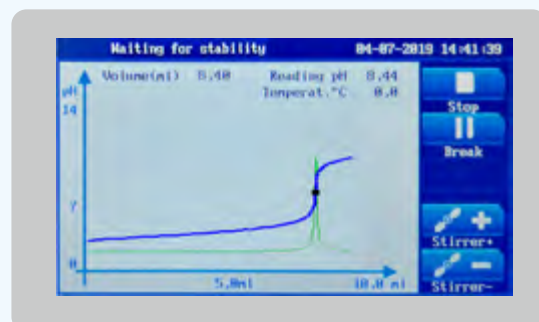

Specification – CAT

	Features
Display	4.3" monochromatic LCD touch screen
Burette dispensation accuracy	Syringe volume: 10mL (It is possible to install up to 2 burettes) Burette for titrant dosage resolution at 12,000 steps (means 0.83 µL at any step)
Dispensation accuracy	<0.2% (2µL with 10ml syringe)
Dispensation repeatability	± 0.2% (2µL with 10ml syringe)
Peristaltic pump	Interchangeable pump head (up to 3 per unit), 1ml/sec.
pH	Range: 0-14pH, Accuracy:±0.02pH, Resolution:±0.01pH
mV	Range: ±2000mV, Accuracy:±2mV, Resolution:±0.1mV
µA	Range: ±10µA, Accuracy:±2µA, Resolution:±0.1µA
Temperature	Range: 0-100°C , Accuracy:±1°C , Resolution:±0.1°C
Utility procedures	1.Priming 2.Cleaning 3.Electrode calibration
Method template	EP, EQ, free SO ₂ , total SO ₂ and double SO ₂
pH calibration	Automatic buffer recognition. Refusal of defective electrodes. Notice expired calibration (to be set from 0 to 7 days). Temperature compensation with pt100 probe during pH calibration 1. 1 buffer calibration (7) 2. 2 buffers calibration (7, 4 or 10) 3. Theoretical (Nernst equation) 4. Oenological: 2 buffers calibration (7, 3)
Communication	1. Electrode port (x2) 2. USB A 3. USB B 4. RS232 serial (for external printer) 5. RS232 serial (for sampler) 6. Bluetooth (for external PC)
Internal memory	Last 50 analyses and last 10 calibrations Up to 30 methods Data export: (date, hour, operator ID, sample ID, method, result, titrant volume) a) To USB pen drive (file csv) b) To external pc (via dedicated
Accessories	1. Printer 2. Single analysis stand 3. 16-position sampler 4. 35-position micro-sampler 5. Auto-level adjuster 6. Automatic degasser 7. Software for data management on external PC

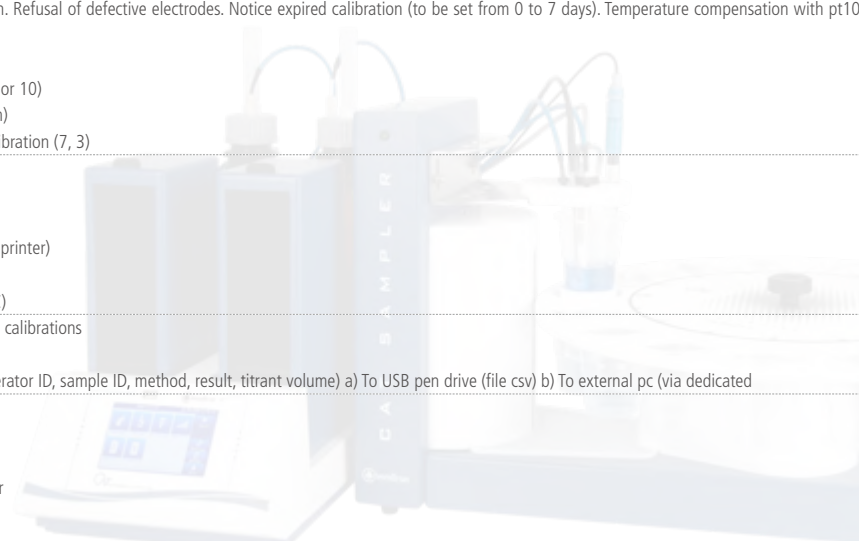

Order index, for your custom unit configuration

Order No.	CAT	M1	T1	S1	B1	P1	G1	L1
M1								
M2								
M3								
M4								
M5								
M6								
M7								
M8								
T0								
T1								
S1								
S2								
S3								
B1								
B2								
P1								
P2								
P3								
G0								
G1								
L1								
L2								

Order Information



CAT1 Automatic titrator with one burette and magnetic stirrer

Order No.	Model	Description
CAT1-1-M1	Basis set	Basic unit without electrode, including CAT1, magnetic stirrer(1), stir bar(1), 10ml burette(1), titration tube(1), power supply(1), 1L glass bottle(1), GL45 and S40 adapter(1), drying tube(1).
CAT1-1-M2	For pH titration	CAT1-1-M1 with pH electrode and buffer solution
CAT1-1-M3	For Precipitation titration	CAT1-1-M1 with Ag electrode
CAT1-1-M4	For Redox titration	CAT1-1-M1 with Pt electrode
CAT1-1-M5	For Dead stop titration	CAT1-1-M1 with Double Platinum electrode



CAT2 Automatic titrator with two burettes and magnetic stirrer

Order No.	Model	Description
CAT2-1-M1	Basis set	Basic unit without electrode, including CAT2, Magnetic stirrer(1), Stir bar(1), 10ml burette(2), titration tube(2), power supply(1), 1L glass bottle(2), GL45 and S40 adapter(2), drying tube(2).
CAT2-1-M2	For pH titration	CAT2-1-M1 with pH electrode and buffer solution
CAT2-1-M3	For Precipitation titration	CAT2-1-M1 with Ag electrode
CAT2-1-M4	For Redox titration	CAT2-1-M1 with Pt electrode
CAT2-1-M5	For Dead stop titration	CAT2-1-M1 with Double Platinum electrode

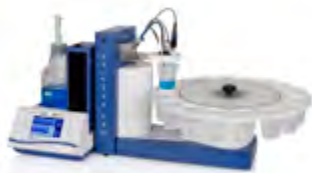

CAT1 Automatic titrator with 16-position auto-sampler

Order No.	Model	Description
CAT1-16-M1	Basis set	Basic unit without electrode, including CAT1, AS24 16 position auto-sampler (1), Stir bar(1), 10ml burette(40), titration tube(2), power supply(1), 1L glass bottle(2), GL45 and S40 adapter(2), drying tube(2).
CAT1-16-M2	For pH titration	CAT1-16-M1 with pH electrode and buffer solution
CAT1-16-M3	For Precipitation titration	CAT1-16-M1 with Ag electrode
CAT1-16-M4	For Redox titration	CAT1-16-M1 with Pt electrode
CAT1-16-M5	For Dead stop titration	CAT1-16-M1 with Double Platinum electrode



CAT2 Automatic titrator with 16-position auto-sampler

Order No.	Model	Description
CAT2-16-M1	Basis set	Basic unit without electrode, including CAT2, AS24 16 position auto-sampler (1), Stir bar(1), 10ml burette(40), titration tube(2), power supply(1), 1L glass bottle(2), GL45 and S40 adapter(2), drying tube(2).
CAT2-16-M2	For pH titration	CAT2-16-M1 with pH electrode and buffer solution
CAT2-16-M3	For Precipitation titration	CAT2-16-M1 with Ag electrode
CAT2-16-M4	For Redox titration	CAT2-16-M1 with Pt electrode
CAT2-16-M5	For Dead stop titration	CAT2-16-M1 with Double Platinum electrode

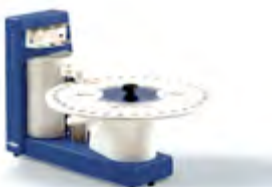

CAT2 Automatic titrator with 35-position micro-sampler

Order No.	Model	Description
CAT2-35-M1	Basis set	Basic unit without electrode, including CAT2, AS24 35 position micro-sampler (1), Stirring paddle(2), 10ml burette(2), titration tube(2), power supply(1), 1L glass bottle(2), GL45 and S40 adapter(2), drying tube(2).
CAT2-35-M2	For pH titration	CAT2-35-M1 with Micro pH electrode and buffer solution
CAT2-35-M3	For Precipitation titration	CAT2-35-M1 with Micro Ag electrode
CAT2-35-M4	For Redox titration	CAT2-35-M1 with Micro Pt electrode
CAT2-35-M5	For Dead stop titration	CAT2-35-M1 with Micro Double Platinum electrode

Case study

Case 1. Determination of total acidity in fruit juice

Application	This method is used for the quantitative determination of total acidity in fruit juice. Here, the citric acid mainly serves as a reference.
Model Recommendations	CAT1-1-M2, CAT2-1-M2, CAT2-16-M2, CAT2-35-M2
Reagents	Titrant: sodium hydroxide solution 0.1 mol/l Soda lime for carbon dioxide uptake of the reagent. Titer: potassium hydrogen phthalate (reference material)

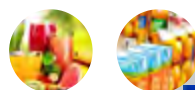

Case 2. Determination of chloride/sodium chloride (salt) in food samples

Application	Potentiometric determination of chloride/sodium chloride ("salt") in food samples such as salt, spice mixtures, cheese, meat or tomato sauce.
Model Recommendations	CAT1-1-M3, CAT2-1-M3, CAT2-16-M3, CAT2-35-M3
Reagents	Solvent: distilled water Titration agent: silver nitrate solution (AgNO ₃) 0.1 mol/L Standard: NaCl titrimetric standard, HNO ₃ 1 mol/l

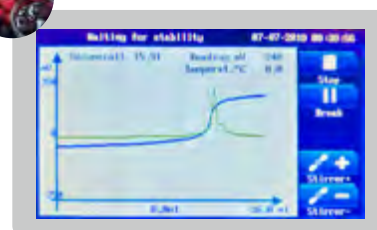

Case 3. Determination of Free and Total SO₂ in Wine and fruit juice

Application	This application note describes the titration procedure with iodine solution.
Model Recommendations	CAT1-1-M5, CAT2-1-M5, CAT2-16-M5, CAT2-35-M5
Reagents	Solvent: distilled water Standardisation: Na ₂ S ₂ O ₃ Titration agent: Iodine solution (I ₂) 0.025 mol/L or 0.01 mol/L Other reagents H ₂ SO ₄ 10 %, NaOH 4 mol/l, KI-solution 5 %

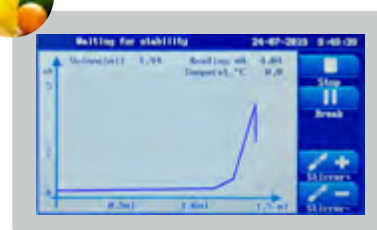

Case 4. Quantitative analysis of ascorbic acid with Iodine titrant

Application	This method is used to determine the content of ascorbic acid (Vitamin C) with the Iodine titrant in juices like orange or apple juice. The sulfite (SO ₂) in the juice is masked before with glyoxal solution.
Model Recommendations	CAT1-1-M5, CAT2-1-M5, CAT2-16-M5, CAT2-35-M5
Reagents	Titration agent: Iodine solution 0.01 mol/L Other reagents: H ₂ SO ₄ 25 % and glyoxal solution 40 %



Accessories and spare parts

Order No.	Model	Description
285101260	pH electrode	Glass shaft, 3 x ceramic junction, gel electrolyte, Silamid®-reference system, sphere membrane, A-glass, length 120 mm, 12 mm Ø, -5...+80 °C, 0...14 pH
285102413	Silver electrode	Glass shaft, platinum junction, electrolyte KNO ₃ 2 mol/l + KCl 0.001 mol/l, Ag/AgCl-reference system, sensor silver cap 4 mm Ø, chlorinated, plug head, length 120 mm, 12 mm Ø, -5...+100 °C
285102002	Redox electrode	Glass shaft, platinum junction, electrolyte KCl 3 mol/l, Silamid®-reference system, sensor platinum pin 1 mm Ø, plug head, length 170 mm, 12 mm Ø, -5...+100 °C
285103512	Double platinum electrode	Double platinum electrode, glass shaft, sensor 2 platinum pins 1 mm Ø, plug head, length 120 mm, 12 mm Ø, -30...+135 °C
285105702	Micro pH electrode	Microelectrode, glass shaft, platinum junction, electrolyte KCl 3 mol/l, Ag/AgCl-reference system, sensor platinum pin 1 mm Ø, 1 m fixed cable with BNC plug, taper NS 7.5, length 96 mm, 5 mm Ø, -5...+100 °C
285122497	Electrode cable	Coaxial electrode plug, 1 m coaxial cable, BNC instrument plug
SFLA2261	Peristaltic pump	Peristaltic pump
SFLA2691	Auto-level adjuster	Auto-level adjuster
SQTR074926	Temperature sensor	Temperature sensor
SFLA2681	Automatic degassing system	Automatic degassing system
SQFV062829	Easydata Software	Easydata Software
SQTR074678	Thermal printer	EPSON Thermal printer
SQTR075651	Printing paper	Printing paper

Portable pH Meter

Portable pH Meter pH 90 is a portable yet highly accurate pH meter. It is used in all industries as well as commercial and educational teaching aids. The meter uses a regular BNC connector and accepts a variety of other electrodes for special measurement needs. The meter comes complete in a hard carrying case with calibration buffer solutions.

Features

- > Large LCD with multiple display, display of pH, temperature and time simultaneously
- > Auto lock Measurement, meter automatically senses a stabilized endpoint reading
- > This ensures workers only takes in an accurate reading all the time and every time.
- > Multi-point calibration (ISO, NIST and manual, up to 5 points calibration)
- > Electrode status indicator, able to display percentage of slope of the electrode after successive calibration. This feature enables users to determine if the electrode should be replaced due to wear and tear.
- > Real time memory, able to save records of up to 99 data memory with date and time, enable download to PC.
- > Online PC link, able to link to a PC for online display with optional PC kit (sold separately) and download saved data. Meter uses regular AAA size batteries and tap power source from PC when connected via the USB cable.

Specifications

Model	pH90			
	pH	mV		Temperature
Range	-2 to 16 pH	±700.0mV	±2,000mV	0 to 120°C
Resolution	0.01pH	0.1mV	1mV	0.1°C
Accuracy	±0.02pH	±0.5mV	±2mV	±0.1 °C ±0.5°C (Probe)
Calibration	Min. 2 point, Max. 5 point			
Buffer Recognition	up to 60°C or 95°C depending on the buffer type			
Automatic Temperature Compensation	pH electrode temperature error compensation 0 to 120°C			
Memory	99 data with real time clock			
Power source	4 x 1.5Volt AAA size battery			
Operating temperature	5 to 40°C			
Storage temperature	-20 to 60°C			
Operating humidity	Up to 95% RH			
Order No.	W8001090			



Portable Dissolved Oxygen Meter

DO 80 is a top range meter for field use. Each meter comes with a 3 meter probe for submerged testing under water in streams, ponds or water tanks. Users can preset salinity compensation and atmospheric compensation to allow direct reading without any conversion tables. It can store up to 99 memory with date and time records. To allow night visibility, there is a backlit display handy. The HD3030 is suitable for aquaculture or industrial users.

Advanced Features:

- > Dual DO and temperature display
- > One touch calibration in air
- > Able to set salinity and atmospheric pressure compensation
- > Save up to 99 data in memory with real time clock
- > Make online data logging on PC with optional RS232 kit
- > Able to show maximum and minimum reading over saved data
- > Backlite for night display

Specifications

Model	DO 80
Range	0 - 20 ppm, 0 - 50°C
Display Resolution	0.01 ppm, 0.1°C
Accuracy (machine only)	± 1.5% FS, 0.3°C
Operating Temperature	0 to 50°C
Calibration	Single point calibration in air at 100%
Battery type	4 x 1.5V AAA size battery or DC9V adaptor (optional item)
Battery life	Approximately 100 hours continuous use
Size	195 x 40 x 36mm
Order No.	W8003080



Portable Conductivity Meter

Portable Conductivity-TDS-Salinity Meter CON 90 is a portable yet highly accurate conductivity meter. It is used in all industries as well as commercial and educational teaching aids. It has full functionality that matches an expensive bench meter.

The meter comes complete in a hard carrying case with calibration buffer solutions.

Features

- > Large LCD with multiple display, display of conductivity, TDS, Salinity with temperature and time simultaneously, able to display reading in μ Siemen, mSiemen, ppm, ppt.
- > Auto lock Measurement, meter automatically senses a stabilized endpoint reading
- > This ensures workers only takes in an accurate reading all the time and every time.
- > Automatic Range, meter can automatically switch to the next higher range to enhance the accuracy over the 5 calibrated points.
- > Cell Constant, meter can accept probe of different cell constant 0.1, 1.0 and 10.0
- > TDS Factor, TDS factor can be adjusted to allow higher accuracy of different types of chemical or liquid of known conversion.
- > Real time memory, able to save records of up to 99 data memory with date and time, enable download to PC.
- > Online PC link, able to link to a PC for online display with optional PC kit (sold separately) and download saved data. Meter uses regular AAA size batteries and tap power source from PC when connected via the USB cable.



Specifications

Model	CON90						
	Conductivity / TDS					Salinity	Temperature
Range	0~19.99 μ S	0~199.9 μ S	0~1999 μ S	0~19.99mS	0~199.9mS	0~100.0ppt	0~120 °C
	0~9.99ppm	0~99.9ppm	0~999ppm	0~9.99ppt	0~99.9ppt		
Resolution	0.01 μ S / ppm	0.1 μ S / ppm	1 μ S / ppm	0.01 mS / ppt	0.1 mS / ppt	0.1ppt	0.1 °C
Accuracy	\pm 1% Full Scale						\pm 0.5 °C
Calibration	5 points with 1 point on each range						
TDS Factor	Adjustable from 0.40 to 1.00						
Cell constant	Selectable from 0.1 , 1.0 & 10.0						
ATC	Automatic from 0 - 100 °C						
Memory	99 data with real time clock						
Power source	4 x 1.5Volt AAA size battery						
Battery Life	40 hours of continuous use with white backlight on						
Order No.	W8002090						

Digital LUX Meter

Digital Lux Meter is a versatile and portable light meter. It measures up to 50,000 Lux with a semi-spherical sensor. The remote sensor allows users to set the light sensor at various tight locations and angles thus providing flexibility to measure light intensity at the exact spot. The digital Lux meter is widely used in commercial setups and agriculture setups.

Features

- > Large LCD
- > Remote Light Sensor
- > 3 switching ranges for 1, 10, 100 Lux resolution

Specifications

Model	HL9040
Range	0 - 50,000 Lux
Display Resolution	Selectable at 1, 10, 100 Lux
Accuracy (machine only)	\pm 5% F.S.
Operating Temperature	0 to 50°C
Operating humidity	Maximum 80% relative humidity
Battery type	DC9V (1604A, 6LF22 or equivalent)
Battery life	Approximately 80 hours
Size	164 x 83 x 35mm
Weight	260gm (main unit including battery)



Benchtop pH Meter

Features

- > Large LCD with Multiple Display, display of pH, temperature and time simultaneously
- > Hold Display function, automatically lock reading when a stable reading is established.
- > Multi point calibration, automatic buffer recognition with built-in standards:
 - ISO - pH7.00, 4.01, 10.01
 - NIST - pH6.68, 4.01, 9.18
 - Custom - Manual set to any buffer standard.
- Up to 5 points calibration



Specifications

Model	pH610		
	pH	mV	Temperature
Range	0 to 14 pH	± 1999 mV	0 to 90°C
Display Resolution	0.01 pH	0.1-199.9 mV 1-1999 mV	0.1°C
Accuracy	± 0.02 pH	±0.2 mV ±2 mV	± 0.5°C
Calibration	5 point selectable		
Operating Voltage	9 to 12V DC, min 650mA		
Operating Temperature	5 to 40°C		
Storage Temperature	-20 to 60°C		
Slope recognition	±60 mV		
Meter Size	217 x 168 x 585mm		
Order No.	W8001610		

Benchtop Conductivity Meter

The Professional Conductivity Bench Meter is a dedicated stationary meter specially designed for laboratory and educational use. It is able to link with a PC for online data logging, or a user can save data in its memory with the date and time and download the data later to a PC. For enhanced accuracy, the meter can calibrate up to 5 points at 1 point on each of its range. The meter is complete with an electrode stand and a PC communication kit.



Specifications

Model	CON 600				
Range	0- 19.99µS	0 - 199.9µS	0 -1999 µS	0 -19.99 mS	0 - 199.9 mS
Display Resolution	0.01 µS	0.1 µS	1 µS	0.01 mS	0.1 mS
Accuracy	± 1% F.S. + 1digit				
Calibration	5 point with 1 point on each range				
TDS factor	Adjustable 0.3 to 1.00				
Temperature compensation	Automatic 0 to 80°C				
Memory	99 data with real time clock				
Operating Temperature	5 to 40°C				
Storage Temperature	-20 to 60°C				
Operating humidity	Up to 95% relative humidity				
Meter Size	217 x 168 x 585mm				
Order No.	W8002600				



Accessories

Electrode / Probe

Order No.	Model	Description	Suitable for
H011-AS004	pH electrode	Glass body combination pH electrode, General purpose, 0.9m cable	pH 90
H012-0001	pH electrode	Glass body combination pH electrode with Pointed-Tip 0.9m cable	pH 90
H045-AP001	pH electrode	Glass body combination pH electrode with Flat tip 0.9m cable	pH 90
H04C-A0001	Micro pH electrode	Glass body combination pH electrode, Length: 50 / 80mm, $\Phi 12/\Phi 5$ mm, 0.9m cable	pH 90
CT25-A0016	Conductivity electrode	Plastic body conductivity electrode platinized Platinum cell K=1	CON 90
CT25-A0026	Conductivity electrode	Plastic body conductivity electrode platinized Platinum cell K=0.1	CON 90
CT25-A0036	Conductivity electrode	Plastic body conductivity electrode platinized Platinum cell K=10	CON 90
HT31-A0001	pH electrode	Glass body combination pH electrode, General purpose, 0.9m cable	pH610
CT25-A0009	Conductivity electrode	Plastic body conductivity electrode platinized Platinum cell K=1	CON600
DOG2-A0001	DO electrode	Dissolved Oxygen electrode with 0.9 meter cable for D080	D080



pH Reference Solution

Order No.	Model	Description
RFOZNO-A125	RFOZNO	4M KCl, without Ag/AgCl, 125ml
RFOZNO-A500	RFOZNO	4M KCl, without Ag/AgCl, 500ml
RFOZAG-A125	RFOZAG	4M KCl, with Ag/AgCl, 125ml
RFOZAG-A500	RFOZAG	4M KCl, with Ag/AgCl, 500ml

pH buffer solution

Order No.	Model	Description
SDH401-A125	SDH401	CAL pH 4.01 Standard pH buffer Solution, 125ml
SDH401-A500	SDH401	CAL pH 4.01 Standard pH buffer Solution, 500ml
SDH686-A125	SDH686	CAL pH 6.86 Standard pH buffer Solution, 125ml
SDH686-A500	SDH686	CAL pH 6.86 Standard pH buffer Solution, 500ml
SDH701-A125	SDH701	CAL pH 7.00 Standard pH buffer Solution, 125ml
SDH701-A500	SDH701	CAL pH 7.00 Standard pH buffer Solution, 500ml
SDH918-A125	SDH918	CAL pH 9.18 Standard pH buffer Solution, 125ml
SDH918-A500	SDH918	CAL pH 9.18 Standard pH buffer Solution, 500ml
SDH100-A125	SDH100	CAL pH 10.01 Standard pH buffer Solution, 125ml
SDH100-A500	SDH100	CAL pH 10.01 Standard pH buffer Solution, 500ml

Standard DO Solution

Order No.	Model	Description
DOGALSO-A125	DOGALSO	Electrolyte for DO electrode, 125ml
DOGALSO-A500	DOGALSO	Electrolyte for DO electrode, 500ml

Standard Conductivity Solution

Order No.	Model	Description
SDCO08-A125	SDCO08	CAL 84uS Standard Conductivity Solution, 125ml
SDCO08-A500	SDCO08	CAL 84uS Standard Conductivity Solution, 500ml
SDCO14-A125	SDCO14	CAL 1413uS Standard Conductivity Solution, 125ml
SDCO14-A500	SDCO14	CAL 1413uS Standard Conductivity Solution, 500ml
SDC128-A125	SDC128	CAL 12.88mS Standard Conductivity Solution, 125ml
SDC128-A500	SDC128	CAL 12.88mS Standard Conductivity Solution, 500ml
SDC150-A125	SDC150	CAL 15.0mS Standard Conductivity Solution, 125ml
SDC150-A500	SDC150	CAL 15.0mS Standard Conductivity Solution, 500ml

pH/ORP Storage and Cleaning Solution

Order No.	Model	Description
CSHOST-A125	CSHOST	pH/ORP Storage solution, 125ml
CSHOST-A500	CSHOST	pH/ORP Storage solution, 500ml
CSHOCL-A125	CSHOCL	pH/ORP Cleaning solution, 125ml
CSHOCL-A500	CSHOCL	pH/ORP Cleaning solution, 500ml
CSHOPC-A125	CSHOPC	pH/ORP Cleaning solution for Protein, 125ml
CSHOPC-A500	CSHOPC	pH/ORP Cleaning solution for Protein, 500ml

Refractometer

WIGGENS offer various model of refractometer for the measurement of sugar, prediction of alcohol and salinity. These meters are self-contained and made of precision prism and optics. Most of the meters come with bi-metal automatic temperature compensation. The mechanical designs require no batteries to operate.

Sugar Refractometer	Range	Resolution
BR0010N	0~10%	0.1%
BR0018N	0~18%	0.1%
BR0032N	0~32%	0.2%
BR2862N	28~62%	0.2%
BR5892N	58~92%	0.2%
Sugar Refractometer ATC		
BR0010T	0~10%	0.1%, ATC
BR0018T	0~18%	0.1%, ATC
BR0032T	0~32%	0.2%, ATC
BR2862T	28~62%	0.2%, ATC
BR5892T	58~92%	0.2%, ATC
Salinity Refractometer		
SA0010	0~100‰ 1.000~1.070	1‰ 0.005
SA0028	0~28%	0.2%
Salinity Refractometer ATC		
SA0010T	0~100‰ 1.000~1.070	1‰ 0.005
SA0028T	0~28%	0.2%
Honey refractometer		
HN1230	12-30% Honey Moisture 58-92% Brix 38-43° Be'	0.1% 0.5% 0.5
HN5892	12-27% water	1%
Honey refractometer ATC		
HN1230T	12-30% Honey Moisture 58-92% Brix 38-43° Be'	0.1% 0.5% 0.5
HN5892T	12-27% water	1%
Alcohol Refractometer		
AL-1N	0~80% v/v ;	0~60%(1%) 60~80%(2.5%)
AL-2N	0~80% w/w ;	0~60%(1%) 60~80%(2.5%)
AL-3N	0~25% v/v	0.1%
AL-4N	0~25% v/v 0~40% Brix	0.1% 0.2% Brix
AL-5N	0~25% v/v 0~20% Baume	0.1% 0.2% Baume
Alcohol Refractometer ATC		
AL-3T	0~25% v/v	0.2%
AL-4T	0~25% v/v 0~40%Brix	0.2% 0.2%
AL-5T	0~25% v/v 0~20Baume	0.2% 0.2
Wine Refractometer		
WN-1N	0~1400e 0~25KMW (Babo) 0~32%Mas Sacch	1 0.2 0.2%
WN-2N	0~1700e	2
WN-3N	3~1400e 0~32%	1 0.2%

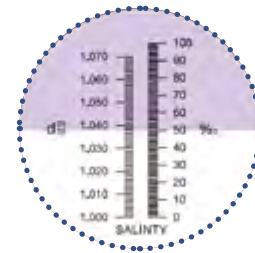
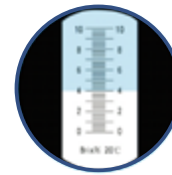
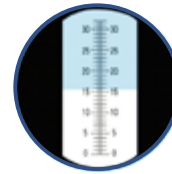

Wine Refractometer ATC		Range	Resolution	
WN-1T		0~1400e	1	
		0~25KMW(Babo)	0.2	
		0~32%Mas Sacch Temperature offset	0.2%	
WN-2T		0~1700e Temperature offset	2	
WN-3T		3~1400e	1	
		0~32%, Temperature offset	0.2%	
Urea Refractometer (Medical)				
UR-1N		0~12g/dl	0.2g/dl	
UR-2N		0~12g/dl	0.2g/dl	
		1.000~1.050sg	0.002sg	
		1.3330~1.3600RI	0.00025RI	
Urea Refractometer ATC (Medical)				
UR-1T		0~12g/dl	0.2g/dl	
		1.000~1.040sg	0.002sg	
UR-2T		0~12g/dl	0.2g/dl	
		1.000~1.050sg	0.002sg	
		1.3330~1.3600RI	0.00025RI	
Digital Refractometer				
Model	Scales	Range	Resolution	Accuracy
BR0035	Brix	0 ~ 35%	0.1	±0.5
	RI	1.3330 ~ 1.3900	0.0001	±0.0005
BR5892	Brix	58-92%	0.1	±0.5
	RI	1.4370 ~ 1.5233	0.0001	±0.0005
BR0085	Brix	0-85%	0.1	±0.5
	RI	1.3330 ~ 1.5100	0.0001	±0.0005
SA0028	NaCl	0-28%	0.1	±0.2
	RI	1.3330 ~ 1.4100	0.0001	±0.0003
SA0035	NaCl (Solubility)	0-30%	0.1	±0.2
	RI	1.3330 ~ 1.4100	0.0001	±0.0003
SA0100	Sea Water Salinity	0-100%	0.1	±0.2
	Sea Water Specific Gravity	1.000 ~ 1.070	0.001	±0.001
WN3150	Oe (Germany)	3 ~ 150	1	±1
	Oe (Swiss)	0-150	1	±1
	Mass S/W	0-35%	0.1	±0.2
	Vol AP	0-22%	0.1	±0.2
	KMW	0-25	0.1	±0.2
EG3258	EG (CRC88)	32 ~ (-58) °F	0.1 °F	±1 °F
		0 ~ (-50)°C	0.1°C	±0.5°C
		0 ~ 75% Volume	0.1	±0.3
PG3258	PG (CRC88)	32 ~ (-58) °F	0.1 °F	±1 °F
		0 ~ (-50)°C	0.1°C	±0.5°C
		0 ~ 60% Volume	0.1	±0.3
ET0060	Ethanol	0 ~ 60% Volume	0.1	±0.3
		0 ~ 60% Weight	0.1	±0.3
MT0060	Methanol	0 ~ 60% Volume	0.1	±0.5
		0 ~ 60% Weight	0.1	±0.5
		0 ~ (-50) °C	0.1°C	±0.5°C
		32 ~ (-58) °F	0.1 °F	±1 °F
IPA0060	Isopropyl Alcohol (IPA)	0 ~ 60% Volume	0.1	±0.5
		0 ~ 60% Weight	0.1	±0.5
		0 ~ (-50) °C	0.1°C	±0.5°C
		32 ~ (-58) °F	0.1 °F	±1 °F
PLA0043	Plato	0-43%	0.1	±0.1
	Plato Specific Gravity	1.000-1.134	0.001	±0.001
SM0035	RI	1.3330-1.4082	0.0001	±0.0003
	Soymilk	0 ~ 35%	0.1	±0.1
	RI	1.3330-1.4100	0.0001	±0.0003



Gas Generator

THE RIGHT GAS GENERATORS FOR YOUR EVERY APPLICATION



Hydrogen Generator

Series	Name	Flow rate	Purity	Pressure
HK Plus	Hydrogen generators, High Purity	100~250mL/min	99.9996%	7bar
PG Plus	Hydrogen generators, High Purity	100~600mL/min	99.9997%	11bar
NM Plus	Hydrogen generators, Ultra purity	100~1350mL/min	99.99996%	11bar
RACK	Hydrogen generators, 19" Rack version	100~1350mL/min	99.9996%(PG Plus) 99.99999%(NM Plus)	11bar



Hydrogen and Zero Air Generator

Series	Name	Flow rate	Purity	Pressure
FID TOWER	Hydrogen generators, Tower version	100~1350mL/min (H ₂) 1800 / 5000mL/min (Zero Air)		11bar
FID FLAT	Hydrogen generators, Flat version	100~1000mL/min (H ₂) 1800 / 5000mL/min (Zero Air)	99.9996%(PG Plus) 99.99999%(NM Plus)	11bar
RACK	Hydrogen generators, 19" Rack version	100~1350mL/min (H ₂) 1800 / 5000mL/min (Zero Air)		11bar



Zero Air Generator

Series	Name	Flow rate	Purity
EZ	Air compressor, oilless and low noise	1~2L/min	Zero air
GC	Zero air generators	1.5~30L/min	HC & CO Content : <0.1ppm
GT	Ultra zero air generators	1.5~30L/min	HC & CO Content : <0.1ppm CO ₂ Content : <5ppm NOX SOX Content : <0.1ppm
RACK GC	Zero air generators, 19" Rack version	1.8~15L/min	HC & CO Content : <0.1ppm



 Nitrogen Generator

Series	Name	Flow rate	Purity	Pressure
N2 TOWER Plus	Nitrogen generators, High Purity	200~4000mL/min	99.9999%	5bar
MINI WHISPER	Nitrogen generators	5~12L/min	98~99.9%	7bar
WHISPER	Nitrogen generators for LC/MS	10~120L/min	98~99.9%	7bar
WIND	Nitrogen generators, Large flow rate (Built-in air compressor)	3~80L/min	90~99.5%	5.5bar
WIND CAD	Nitrogen generator for CAD	5NL/min	For CAD	5.5bar
WIND ELSD	Nitrogen generator for ELSD	10NL/min	For ELSD	5.5bar
WIND EVA M	Nitrogen generator for nitrogen blowing instrument	35NL/min	98.5%	5.5bar
WIND MS	Nitrogen generators, for LC/MS (Built-in air compressor)	5~80L/min	96~99.9%	8bar
WIND MS 5500HB	Nitrogen generators, for LC/MS	Suitable for models below AB SCIEX 5500		
MISTRAL EVO	Nitrogen generators (Built-in air compressor)	10~40L/min	99~99.9%	8bar
WIND XL	Industrial high purity nitrogen supply system	1-3500L/min	95-99.999%	7.5bar
AEOLUS	Nitrogen generator module	40L/min and 80L/min	99.5%	8.5~10 bar

 Nitrogen and Zero Air Generator

Series	Name	Flow rate	Purity
MINI WHISPER HYBRID	Nitrogen and Zero air generator	5~12L/min (N2) 35L/min (Zero Air)	98~99.9%
WHISPER HYBRID	Nitrogen and Zero air generator for LC/MS, Large flow rate	10~120L/min (N2) 35 / 70L/min (Zero Air)	98~99.9%
MISTRAL EVO HYBRID	Nitrogen and Zero air generator (Built-in air compressor)	12L/min (N2) 24L/min (Zero Air)	99~99.9%
MISTRAL EVO GAS-STATION	Nitrogen and Zero air generator (Built-in air compressor)	25L/min (N2) 40L/min (Zero Air)	99~99.9%



 Compressed Air System / Purified Air System

Series	Name	Flow rate	Pressure
P	Compressed air system	30~60L/min	0~8bar
GH	Purified air system	6~40L/min	0~9.5bar



WIGGENS
THE MAGIC MOTION



WIGGENS China

Building No. 45, Tianshan International Enterprise Base,
Yanjiao Economic Development Zone, Beijing, China
Tel : +86-4008092068



WIGGENS GmbH

Gässlesweg 22-24, 75334 Straubenhardt
Tel: +49 7248 4529088
info@wiggens.com
www.wiggens.com