

English

# OPERATING MANUAL

## Rotary Vane Vacuum Pump

R-8D/R-24D/R-36D



**WIGGENS**  
THE MAGIC MOTION

### WIGGENS GmbH

Gässlesweg 22-24, 75334 Straubenhardt,  
Germany

Tel.: 0049 7248 4529088

### Wiggins Co., Ltd.

Room 426, Hall A, Office Building M8, No.1  
Jiuxianqiao East Road, Chaoyang District,  
Beijing 100015, China

Tel: +86 400-809-2068

Fax: +86 400-809-2068-112

info@wiggins.com

www.wiggins.com

## Congratulations!

You have made an excellent choice.

WIGGENS thanks you for the trust you have placed in us.

This operating manual has been designed to help you gain an understanding of the operation and possible applications of our instruments. For optimal utilization of all functions, we recommend that you thoroughly study this manual prior to beginning operation.

## Unpacking and Inspecting

Please unpack the device carefully. Check that the package is right-side-up and then open it. Check that model of the product is one that you ordered. Check that there is no damage. If there is any damage, file a damage claim with the carrier. In the case of any damage a damage report should be requested immediately. These instructions must be followed fully for us to guarantee our full support of your claim for protecting against loss from concealed damage. The form required for filing such a claim will be provided by the carrier.

Changes without prior notification reserved

**Important:** keep operating manual for future use

# Content

1. Intended Use .....	4
2. Operator Responsibility .....	4
2.1. Disposal .....	5
CE Conformity .....	5
2.2. Technical Specifications .....	6
3. Safety Instructions .....	7
3.1. Explanation of Safety Notes .....	7
3.2. For Your Protection .....	8
3.3. For protection of the equipment .....	9
4. Operating Procedures .....	10
4.1. Environmental Operating Conditions .....	10
4.2. Installation .....	10
4.2.1. General Installation Instruction .....	10
4.2.2. Connecting the Pump to a System .....	11
4.2.3. Wiring .....	11
4.2.4. The dimensions of the Rotatory Vane vacuum pumps .....	12
4.3. Operation .....	12
4.3.1. Pre-Operation Inspection .....	12
4.3.2. Diagram with Description .....	13
4.3.3. Start-Up of the Vacuum Pump .....	13
5. Cleaning and Maintenance .....	14
5.1. Routine Cleaning .....	14
5.2. Maintenance .....	15
5.2.1. Routine Maintenance .....	15
5.2.2. Maintenance intervals .....	16
6. Transport and Storage .....	17
7. Service .....	17
7.1. Trouble-Shooting .....	17
7.2. Warranty .....	18
7.3. Contact /Technical Service .....	18

## 1. Intended Use

The R-8D/R-24D/R-36D Rotary Vane Vacuum Pump is intended for acquiring coarse vacuum. It is widely used in scientific research and industrial production which requires a mid-level to low-level vacuum environment.

The pump can either be used independently or as a pre-pump for high and ultra high vacuum systems, such as molecular pumps or diffusion pumps.

The pump employs a check valve system that prevents oil returning, a pressure oil circulating system, and a convenient gas ballast valve control. This pump is features a deep ultimate vacuum, low noise, and a leakage-free design.

## 2. Operator Responsibility

The products of WIGGENS ensure safe operation when installed, operated, and maintained according to common safety regulations. This section explains the potential dangers that may arise when operating the instrument and also specifies the most important safety precautions to preclude these dangers as far as possible.

- The operator is responsible for the qualification of the personnel operating the instrument.
- The personnel operating the instrument should be regularly instructed about the dangers involved with their job activities as well as measures to avert these dangers.
- Make sure all persons tasked with operating, installing, and maintaining the instrument have read and understand the safety information and operating instructions.
- When using hazardous materials or materials that could become hazardous, the instrument may be operated only by persons who are absolutely familiar with these materials and the instrument. These persons must be fully aware of possible risks.
- Only qualified personnel are authorized to perform configuration, installation, maintenance and repairs of the instrument.
- Routine operation can also be carried out by untrained personnel who should however be instructed by trained personnel.

If you have any questions concerning the operation of your instrument or the information in this manual, please contact us!

## 2.1. Disposal

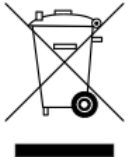

At the end of its service life the instrument is to be disposed of in accordance with the local regulations specified for the disposal of electronic industry waste in an environmentally friendly manner.

## CE Conformity



The products described in the operating instructions conform to the requirements of the following European guidelines:

Low voltage regulations with respect to legal harmonization of the member countries concerning electric devices for use within certain voltage limits.

EMC guideline with respect to legal harmonization of the member countries concerning electromagnetic compatibility.

<b>APPROVALS</b> European	EN61326-1: 2013, 2014/30/EU
	EN61010-1: 2010, 2014/35/EU
	EN60204-1: 2006, 2006/42/EC
	EN50581: 2012, 2011/65/EU

## 2.2. Technical Specifications

Model	R-8D	R-24D	R-36D
Ultimate Vacuum (mbar)	$4 \times 10^{-4}$	$4 \times 10^{-4}$	$4 \times 10^{-4}$
Flow Rate (L/min)	180	360	540
Oil Capacity (L)	1.1	1.9	2.1
Inlet Port (DN)	25KF	25KF	25KF
Outlet Port (DN)	25KF	25KF	25KF
Pump Speed (rpm)	1400	1400	1400
Weight (Single Phase) (kg)	29	37	39
Noise Level (dB)	<54	<56	<56
Power (W)	550	750	1100
Dimensions (D x L x H in mm)	495 x 165 x 252	535 x 205 x 288	565 x 205 x 296
Mains	AC230V 50 / 60Hz	AC230V 50 / 60Hz	AC230V 50 / 60Hz
Order No.	900111-22	900025-22	900035-22

All measurements have been carried out at the stated voltage, frequency, and an ambient temperature of 25°C.  
 Technical changes without prior notification reserved.





*WIGGENS* Order Numbers consist of the Basic Order Number (BON) and the Order Number Addition (ONA) which explains different characteristics of the product that can vary from country to country. Order Numbers as stated on the product label and box label are stated as Full Order Numbers (FON), consisting of the BON followed by the ONA. For a full explanation of the ONA of your product, please ask your local *WIGGENS* support or refer to the Order Number Guide in the *WIGGENS* General Catalog.





## 3. Safety Instructions

### 3.1. Explanation of Safety Notes

In addition to the safety warnings listed, warnings are posted throughout the operating manual. These warnings are designated by an exclamation mark inside an equilateral triangle. "Warning of a dangerous situation (Attention! Please follow the documentation)."

Symbol	Additional term / Description
<b>Warning signs</b> 	<p>The danger is classified using a signal word. Read and follow these important instructions for averting dangers.</p> <p><b>Warning!</b>            Describes a <b>possibly</b> highly dangerous situation. If these instructions are not followed, serious injury and danger to life could result.</p> <p><b>Caution!</b>            Describes a <b>possibly</b> dangerous situation. If this is not avoided, slight or minor injuries could result. A warning of possible property damage may also be contained in the text.</p> <p><b>Notice!</b>            Describes a <b>possibly</b> harmful situation. If this is not avoided, the product or anything in its surroundings can be damaged.</p>
	<p><b>Note!</b>            Draws attention to something special.</p>
	<p><b>Important!</b>            Indicates usage tips and other useful information.</p>

## 3.2. For Your Protection

- Make sure you read and understand all instructions and safety precautions listed in this manual before installing or operating your instrument.
- Keep the operation instructions in a place where they can be accessed by everyone.
- Connect the instrument to a power socket with earthing contact (PE-protective earth)!
- The power supply plug serves as a safe disconnecting device from the line and must always be easily accessible.
- Do not stay in the area below the instrument.
- Make sure the product is checked for proper condition regularly (depending on the conditions of use). Regularly check (at least every 2 months) the proper condition of them and a tory, warning, prohibition and safety labels.
- Never operate damaged equipment.
- Always turn off the instrument and disconnect the mains cable from the power source before performing any service or maintenance procedures, or before moving the instrument.
- Transport the instrument with care.
- Never operate instruments with damaged mains power cables.
- Observe all warning labels.
- Never remove warning labels.
- Repairs are to be carried out only by qualified service personnel
-  **Warning!** Never use the pump with any flammable gas or toxic material.
-  **Warning!** Before using a medium, check whether the medium can be transferred danger-free in the specific application case.
-  **Warning!** Ensure that the system is not subject to any risks of explosion, also in extreme operating situations (temperature, pressure) or in case of malfunctions.
-  **Warning!** Only transfer gases which remain stable under the Vacuum and temperatures occurring in the pump.
- Laboratory equipment or additional components connected to a pump have to be suitable for use with the pneumatic capabilities of the pump
-  **Warning!** Make sure the temperature of the medium is always sufficiently below the ignition temperature of the medium, to avoid ignition or explosion.
- If necessary, consider any external sources of energy, such as radiation, that may add heat to the medium.
- This is not an explosion proof vacuum pump. Do not use with any highly flammable or explosive materials.
- For safety reasons place the vacuum pump at least 50 cm from any inflammable material!
- Be aware of the danger of electric shocks!
- Be aware of tripping! Never route the connection cable in highly frequented areas!
- Be aware of the potential danger of a fire outbreak due to overheating!



- Never operate the vacuum pump on home furniture!
- Never spray flammable or toxic materials onto the pump
- If the supply cord is damaged, it must be replaced by the manufacturer or its service agent or a competent person in order to avoid hazard.

### 3.3. For protection of the equipment

- You have received a product designed for industrial and experimental use. Nevertheless, avoid strikes to the housing, vibrations, damage to the operating-element panel, and contamination.
- Make sure that the mains power supply has low impedance to avoid any negative effects on instruments being operated on the same mains.
- Do not expose the unit to sunlight.
- Sudden drops may cause damage in the interior of the instrument.
- Never use the pump with any flammable gas or toxic material.
- Press the power switch to interrupt the pump, rather than disconnect the main power plug directly.
- When in an emergency, disconnect the main power plug.
- Protect the pump from vibrations, jolts and external damage.
- The pump is not recommended for use underground.
- The pump is not suitable for transferring dusts.
- The pump is not suitable for transferring liquids.
-  **Warning!** An overpressure must not be applied to the suction side of the pump.
- The pumps must not be modified. If a wearing part is replaced, the original function of the pump must be checked by reaching the specified ultimate vacuum.
- Never operate the vacuum pump in wet areas!

## 4. Operating Procedures

### 4.1. Environmental Operating Conditions

The vacuum pump must operate in the following conditions:

- Indoors
- Altitudes up to 2000 meters
- Temperatures from +5°C to +40°C
- Maximum relative humidity 80% for temperatures up to +31°C, linear decrease down to 50% relative humidity at a temperature of +40°C
- Max. mains fluctuation of  $\pm 10$  % are permissible
- Overvoltage category II

### 4.2. Installation

#### 4.2.1. General Installation Instruction

- Place the vacuum pump on a stable, flat surface and proper environment for operation.
- When connecting the pump to a system use the anchor holes to stabilize it
- Connect the vacuum pump to a power socket with earthing contact.



#### CAUTION!

- The installation of the pump on an unstable surface may lead to increased noise and damage to the pump
- Do not use voltages that are higher or lower than 10% of the voltage specified on the label, which is on the backside of the instrument.
- The vacuum pump is not corrosion resistant. Do not operate it with corrosive gases directly
- When the pump is used in water filtration, prevent the liquid level in the flask / waste bottle from exceeding the safety level. Failure to comply can result in serious damage to the pump and void the warranty.
- If the pump fails to work during operation, first release the vacuum, and then turn it on again. Failure to comply may result in overloading and damage to the motor.
- Do not use any lubricant which may damage the pump.
- Use the pump in a dry, clean, and well-ventilated area.

#### 4.2.2. Connecting the Pump to a System

1. Employ international standard "quick release flanges" to link the pump's air inlet to the vacuum system, and its air outlet to the exhaust duct.
2. Check the cleanness of the joint of duct and flange.



#### Note!

When polluted, the duct and flange could have a severe impact on performance of the pump. Therefore the joint should be kept clean as much as possible.

3. The length and diameter of the duct connecting the pump and vacuum system should be as short and big as possible, respectively.
4. Dimensions of the connecting duct should be consistent with those of the air inlet and outlet.



#### Note!

- If the diameter of the duct is smaller than that of the air inlet, the pumping rate will decrease.
- If the diameter of the duct is smaller than that of the air outlet, pressure in the oil tank will rise and make the degree of vacuum unstable.

5. Perform leak detection for the joint between duct and flange.

#### 4.2.3. Wiring

- Check and ensure that the power supply has been cut off prior to wiring.
- Wiring should be performed by a professional electrician according to the label of motor.
- Wiring should be conducted in accordance with rated values indicated on the label of the motor.
- It is critical to ensure that the motor rotates correctly after it is powered on.
- Check the direction of rotation of the motor with the air inlet cover. Open the air inlet and outlet and place the cover on the air inlet. Power on for a test run for an instant, and at the same time, observe the air inlet cover which will be caught up when the motor is rotating correctly.

### 4.2.4. The dimensions of the Rotatory Vane vacuum pumps

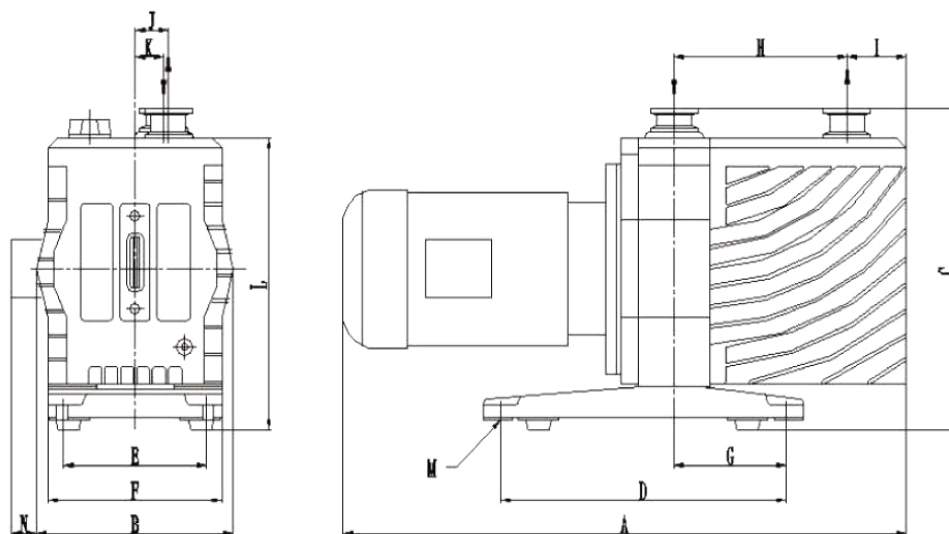

	A	B	C	D	E	F	G	H	I	G	K	L	M	N
R-8D	495	165	252	240	120	146	94	145	50	24	28	229	φ9	53
R-24D	535	205	288	310	140	180	147	156	75	40	34	262	φ12	48
R-36D	565	205	288/296	310	140	180	147	186	75	40	34	262	φ12	48

## 4.3. Operation

### 4.3.1. Pre-Operation Inspection

- The air outlet of the pump must be clear. Starting the pump when the air outlet is blocked can damage the pump
- Make sure that sufficient oil is in the designated tank by checking the observation window
- Check the rotation direction of the motor after a wiring change.
- After an oil change or when the pump has not been used for a longer period, it should be started up with its air inlet covered so as to exhaust air in the pump oil.

### 4.3.2. Diagram with Description

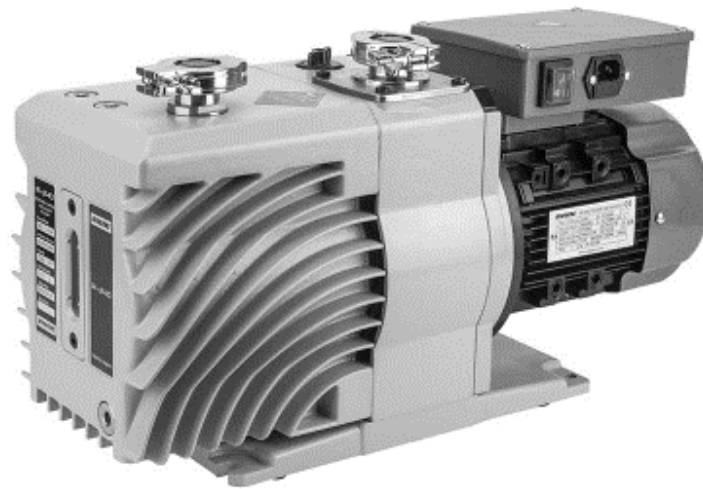

R-8D

### 4.3.3. Start-Up of the Vacuum Pump

- 1) Without condensable gas
  - When the pump is used to eject permanent gas, the gas ballast control nut should be set to the "off" position.
- 2) With condensable gas
  - The air inlet cannot be exposed to steam prior to its operating temperature.
  - If the pump operates at a lower temperature, steam may dissolve in pump oil.
  - When steam dissolves in pump oil, oil may change with regard to its performance and consequently may cause corrosion to the pump body. Therefore, do not shut the pump down immediately, but let the pump work for a few more minutes after the regular operation. Block the air inlet with the gas ballast valve opened in order to allow the pump to separate the steam from the pump oil.
  - In continuous operation of the pump condensable steam can be ejected from the system when the gas ballast valve is opened. When the pressure decreases to a certain value, close the gas ballast valve, and proceed with pumping.
- 3) Make sure that the operating temperature of the pump lies within the range of +40°C ~ +80°C

## 5. Cleaning and Maintenance

### 5.1. Routine Cleaning

Wipe the housing of the instrument with a damp cloth using a mild soap and water solution.

#### Cleaning

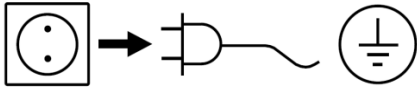

For cleaning disconnect the main plug.

Only use cleansing agents which have been recommended by WIGGENS

Use to remove:

Dyes isopropyl alcohol

Construction materials isopropyl alcohol/water containing surfactant

Cosmetics isopropyl alcohol/water containing surfactant

Foodstuffs water containing surfactant

Fuels water containing surfactant

- Do not allow moisture to get into the appliance when cleaning.
- Wear protective gloves when cleaning the devices.
- Before using another than the recommended method for cleaning or decontamination, the user must ascertain with WIGGENS that this method does not destroy the instrument



#### **Note:**

Do not use chlorine bleach, chlorine-based cleanser, abrasives, ammonia, steel wool or scouring pads with metal content or similar harsh solvents or abrasives. These may damage the surface of the instrument.

## 5.2. Maintenance

### 5.2.1. Routine Maintenance

- 1) Cut off the power supply before the pump is removed from the vacuum system.
- 2) Check the oil capacity
  - The level of pump oil should be within the Min. and Max. levels (see figure below)
  - In the case of oil starvation, the pump should be stopped for fitting oil.

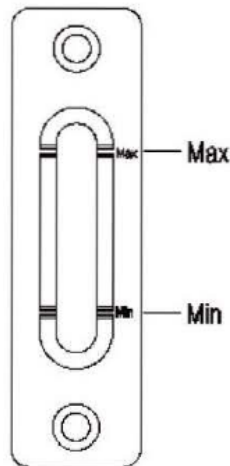

### 3) Check oil quality by visual inspection

- Normal pump oil should be clean and transparent
- If the color of the oil darkens, change oil
- Time for oil change is subject to oil use conditions
- Make inspection records and change oil on a periodical basis

### 4) Oil change

- To ensure functions of the pump and its service life, be sure that the oil is clean and that the oil level appropriate
- Change oil under the following conditions
  - Oil is contaminated
  - Initial use of a new pump
  - When the vacuum level is significantly decreased
- Oil change method
  - Stop the pump
  - Open the drain plug and let contaminated oil flow into a proper container.
  - To empty residual oil in the pump chamber, open the air inlet and run the pump for max. 10s.
  - Open the oil-fill plug, inject new oil, and then tighten the oil-fill plug.
  - Please use high vacuum pump fluid in order to ensure performance of the pump.

5) Cleaning of the filter screen at the air inlet

- The filter screen can prevent particles from entering the pump chamber
- To prevent decrease in pumping speed, the filter screen should be kept clean
- Cleaning method
  - Separate the filter screen and the air inlet
  - Place the filter screen in a container for cleaning
  - Use compressed air to dry the filter screen before reinstallation for use.
- If there's any damage to the filter screen, change it.
- Perform cleaning on a periodical basis

Do not attempt to service or repair a WIGGENS vacuum pump. If the vacuum pump housing is opened the warranty becomes void. Contact WIGGENS for return authorization and return instructions.

**5.2.2. Maintenance intervals**

The intervals stated in the maintenance schedule are approximate values for normal pump operation .unfavorable ambient conditions and/or aggressive media may significantly reduce the maintenance intervals

Maintenance job	frequency
Check the oil level	Daily
1ST oil change	Every 2000~3000h or annually (depend on application)
Subsequent oil changes	monthly
Gas ballast	6 months
Clean the dirt trap	annually
Clean the internal demister	annually
Check the coupling element	annually
Fan cover cleaning	annually
Clean the oil level glass	annually



## 6. Transport and Storage

- Clean the vacuum pump so that it is free from any materials which may be harmful to the health. Provide a material safety data sheet where appropriate.
- When the pump will not be used for a long time, its air inlet and outlet should be sealed off to prevent dust and dirt from polluting the pump body.
- When the pump is not used for a long time gases would adhere to the pump and its sealing elements. When using the pump again after a longer time period, air extraction should be extended appropriately.
- Make sure that the pressure within the pump is equal to atmospheric pressure before storage
- Place the vacuum pump and its parts into the original packing or a container with necessary protection to prevent damage during transport. Seal the original packing or container with packing tape.
- Store the packed unit in a dry place



### CAUTION!

Failure to clean, maintenance, and handle the vacuum pump as outlined can lead to damages or be harmful to the health.

## 7. Service

### 7.1. Trouble-Shooting

Cause	Remedy
Hard to start	<ol style="list-style-type: none"> <li>1. Keep ambient temperature above 10°C</li> <li>2. Check and repair wiring</li> <li>3. Please contact the WIGGENS support.</li> </ol>
Failure to arrive at limit pressure	Please contact the WIGGENS support.



WIGGENS reserves the right to carry out technical modifications with repairs for providing improved performance of the instrument.

## 7.2. Warranty

In accordance with *WIGGENS* warranty conditions, the warranty period is 24 months. For claims under the warranty please contact your local dealer. You may also send the machine direct to our works, enclosing the delivery invoice and giving reasons for the claim. You will be liable for freight costs. The warranty does not cover wearing parts, nor does it apply to faults resulting from improper use or insufficient care and maintenance contrary to the instructions in this operating manual.

*WIGGENS* reserves the right to decide the validity of any warranty claim. In case of faults arising either due to faulty materials or workmanship, parts will be repaired or replaced free of charge.

Any other compensation claims, such as consumables, damages caused by corrosion or accidental breakage, are excluded from this guarantee.

This warranty may only be altered by a specifically published amendment. No individual has authorization to alter the provisions of this warranty policy or its amendments.

## 7.3. Contact /Technical Service

If your device is not working properly:

⇒ Please inform *WIGGENS* Instruments by using our contact information.

You have contacted *WIGGENS* Instruments?

⇒ Copy and complete the Confirmation of condition of unit from these operating instructions.

⇒ Please repack the device appropriately for transport and send to *WIGGENS* Instruments together with the Confirmation of condition of unit.

### Our contact details

#### **WIGGENS GmbH**

Add: Gässlesweg 22-24, 75334 Straubenhardt, Germany

Tel.: 0049 7248 4529088

#### **Wiggens Co., Ltd.**

Room 426, Hall A, Office Building M8, No.1 Jiuxianqiao East Road, Chaoyang District, Beijing 100015, China

Tel: +86 400-809-2068

Fax: +86 400-809-2068-112

info@wiggens.com

service@wiggens.com

www.wiggens.com

## Confirmation of condition of unit

In the case of repair, copy and complete the Confirmation of condition of unit and send it to *WIGGENS* Instruments.

### 1. Details about the unit

Product number \_\_\_\_\_  
 Serial number \_\_\_\_\_  
 Reason for repair \_\_\_\_\_  
 \_\_\_\_\_

### 2. Has the device been cleaned, decontaminated/sterilized?

Yes  No

### 3. Is the unit in a condition which does not represent any health threats for the staff of our service department?

Yes  No

If not, which substances has the unit come into contact with?

\_\_\_\_\_

### 4. Legally binding declaration

The customer is aware of being legally liable to *WIGGENS* Instruments for any damages arising from incomplete and incorrect information.

Date \_\_\_\_\_ Signature \_\_\_\_\_  
 Company stamp \_\_\_\_\_

## Please Note

The shipper is responsible for the return of the goods in well-packed condition, suitable for the mode of transport.

### Sender information

Name \_\_\_\_\_  
 Company \_\_\_\_\_  
 Department, research group Street \_\_\_\_\_  
 Zip code, city \_\_\_\_\_  
 Country \_\_\_\_\_  
 Phone \_\_\_\_\_  
 E-mail \_\_\_\_\_



**WIGGENS GmbH**

Gässlesweg 22-24, 75334 Straubenhardt, Germany

Tel.: 0049 7248 4529088

**WIGGENS China**

Room 426, Hall A, Office Building M8, No.1 Jiuxianqiao East Road,

Chaoyang District, Beijing 100015, China

Tel: +86 400-809-2068

Fax: +86 400-809-2068-112

[info@wiggens.com](mailto:info@wiggens.com)

[www.wiggens.com](http://www.wiggens.com)